

DS14185 EIA/TIA-232 3 Driver x 5 Receiver

General Description

The DS14185 is a three driver, five receiver device which conforms to the EIA/TIA-232-E standard.

The flow-through pinout facilitates simple non-crossover board layout. The DS14185 provides a one-chip solution for the common 9-pin serial RS-232 interface between data terminal and data communications equipment.

Features

- Replaces one 1488 and two 1489s
- Conforms to EIA/TIA-232-E
- 3 drivers and 5 receivers
- Flow through pinout
- Failsafe receiver outputs
- 20-pin SOIC package
- LapLink® compatible –200 kbps data rate

Connection Diagram

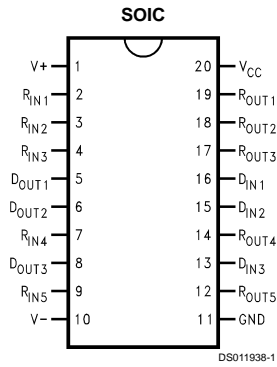

Order Number DS14185WM
See NS Package M20B

Functional Diagram

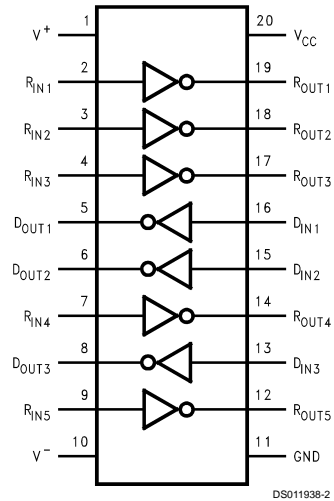

Absolute Maximum Ratings (Note 1)

If Military/Aerospace specified devices are required, please contact the National Semiconductor Sales Office/Distributors for availability and specifications.

Supply Voltage (V_{CC})	+7V
Supply Voltage (V^+)	+15V
Supply Voltage (V^-)	-15V
Driver Input Voltage	0V to V_{CC}
Driver Output Voltage (Power Off)	$\pm 15V$
Receiver Input Voltage	$\pm 25V$
Receiver Output Voltage (R_{OUT})	0V to V_{CC}
Maximum Package Power Dissipation @ +25°C	
M Package	1488 mW
Derate M Package	11.9 mW/°C above +25°C

Storage Temperature Range	-65°C to +150°C
Lead Temperature Range (Soldering, 4 seconds)	+260°C
ESD Ratings (HBM, 1.5 k Ω , 100 pF)	≥ 1.5 kV

Recommended Operating Conditions

	Min	Typ	Max	Units
Supply Voltage (V_{CC})	+4.75	+5.0	+5.25	V
Supply Voltage (V^+)	+9.0	+12.0	+13.2	V
Supply Voltage (V^-)	-13.2	-12.0	-9.0	V
Operating Free Air Temperature (T_A)	0	25	70	°C

Electrical Characteristics (Note 2)

Over recommended supply voltage and operating temperature ranges, unless otherwise specified.

Symbol	Parameter	Conditions	Min	Typ	Max	Units
DEVICE CHARACTERISTICS						
I_{CC}	V_{CC} Supply Current	No Load, All Inputs at +5V		21.0	30	mA
I^+	V^+ Supply Current (Note 2)	No Load, All Driver Inputs at 0.8V or +2V	$V^+ = 9V, V^- = -9V$	8.7	15	mA
			$V^+ = 13.2V, V^- = -13.2V$	13	22	mA
I^-	V^- Supply Current (Note 2)	All Receiver Inputs at 0.8V or 2.4V.	$V^+ = 9V, V^- = -9V$	-12.5	-22	mA
			$V^+ = 13.2V, V^- = -13.2V$	-16.5	-28	mA
DRIVER CHARACTERISTICS						
V_{IH}	High Level Input Voltage		2.0			V
V_{IL}	Low Level Input Voltage				0.8	V
I_{IH}	High Level Input Current (Note 2)	$V_{IN} = 5V$			10	μA
I_{IL}	Low Level Input Current (Note 2)	$V_{IN} = 0V$		-1.24	-1.5	mA
V_{OH}	High Level Output Voltage (Note 2)	$R_L = 3$ k Ω , $V_{IN} = 0.8V$, $V^+ = 9V, V^- = -9V$	6	7		V
		$R_L = 3$ k Ω , $V_{IN} = 0.8V$, $V^+ = +12V, V^- = -12V$	8.5	9		V
		$R_L = 7$ k Ω , $V_{IN} = 0.8V$, $V^+ = +13.2V, V^- = -13.2V$	10	11.5		V
V_{OL}	Low Level Output Voltage (Note 2)	$R_L = 3$ k Ω , $V_{IN} = 2V$, $V^+ = 9V, V^- = -9V$		-7	-6	V
		$R_L = 3$ k Ω , $V_{IN} = 2V$, $V^+ = +12V, V^- = -12V$		-8	-7.5	V
		$R_L = 7$ k Ω , $V_{IN} = 0.8V$, $V^+ = +13.2V, V^- = -13.2V$		-11	-10	V
I_{OS+}	Output High Short Circuit Current (Note 2)	$V_O = 0V, V_{IN} = 0.8V$	-6	-13	-18	mA
I_{OS-}	Output Low Short Circuit Current (Note 2)	$V_O = 0V, V_{IN} = 2.0V$	6	13	18	mA
R_O	Output Resistance	$-2V \leq V_O \leq +2V$, $V^+ = V^- = V_{CC} = 0V$	300			Ω
		$-2V \leq V_O \leq +2V$, $V^+ = V^- = V_{CC} = \text{Open Ckt}$	300			Ω

Electrical Characteristics (Note 2) (Continued)

Over recommended supply voltage and operating temperature ranges, unless otherwise specified.

Symbol	Parameter	Conditions	Min	Typ	Max	Units
RECEIVER CHARACTERISTICS						
V_{TH}	Input High Threshold (Recognized as a High Signal)	$V_O \leq 0.4V$, $I_O = 3.2\text{ mA}$		1.85	2.4	V
V_{TL}	Input Low Threshold (Recognized as a Low Signal)	$V_O \geq 2.5V$, $I_O = -0.5\text{ mA}$	0.7	1.0		V
R_{IN}	Input Resistance	$V_{IN} = \pm 3V$ to $\pm 15V$	3.0	4.1	7.0	k Ω
I_{IN}	Input Current (Note 2)	$V_{IN} = +15V$	2.1	4.1	5.0	mA
		$V_{IN} = +3V$	0.43	0.7	1	mA
		$V_{IN} = -15V$	-5.0	-4.1	-2.1	mA
		$V_{IN} = -3V$	-1	-0.65	-0.43	mA
V_{OH}	High Level Output Voltage (Note 7)	$I_{OH} = -0.5\text{ mA}$, $V_{IN} = -3V$	2.6	4		V
		$I_{OH} = -10\ \mu\text{A}$, $V_{IN} = -3V$	4.0	4.9		V
		$I_{OH} = -0.5\text{ mA}$, $V_{IN} = \text{Open Circuit}$	2.6	4		V
		$I_{OH} = -10\ \mu\text{A}$, $V_{IN} = \text{Open Circuit}$	4.0	4.9		V
V_{OL}	Low Level Output Voltage	$I_{OL} = 3.2\text{ mA}$, $V_{IN} = +3V$		0.2	0.4	V
I_{OSR}	Short Circuit Current (Note 2)	$V_O = 0V$, $V_{IN} = 0V$	-4	-2.7	-1.7	mA

Switching Characteristics (Note 2)

$T_A = 25^\circ\text{C}$

Symbol	Parameter	Conditions	Min	Typ	Max	Units
DRIVER CHARACTERISTICS						
t_{PHL}	Propagation Delay High to Low	$R_L = 3\text{ k}\Omega$, $C_L = 50\text{ pF}$ (Figures 1, 2)		60	350	ns
t_{PLH}	Propagation Delay Low to High			240	350	ns
t_r , t_f	Output Slew Rate (Note 8)			50		ns
RECEIVER CHARACTERISTICS						
t_{PHL}	Propagation Delay High to Low	$R_L = 1.5\text{ k}\Omega$, $C_L = 15\text{ pF}$ (includes fixture plus probe), (Figures 3, 4)		150	350	ns
t_{PLH}	Propagation Delay Low to High			240	350	ns
t_r	Rise Time			87	175	ns
t_f	Fall Time			40	100	ns

Note 1: Absolute Maximum Ratings are those values beyond which the safety of the device cannot be guaranteed. They are not meant to imply that the devices should be operated at these limits. The table of Electrical Characteristics specifies conditions of device operation.

Note 2: Current into device pins is defined as positive. Current out of device pins is defined as negative. All voltages are referenced to ground unless otherwise specified. For current, minimum and maximum values are specified as an absolute value and the sign is used to indicate direction. For voltage logic levels, the more positive value is designated as maximum. For example, if $-6V$ is a maximum, the typical value ($-6.8V$) is more negative.

Note 3: All typicals are given for: $V_{CC} = +5.0V$, $V^+ = +12.0V$, $V^- = -12V$, $T_A = +25^\circ\text{C}$.

Note 4: Only one driver output shorted at a time.

Note 5: Generator characteristics for driver input: $f = 64\text{ kHz}$ (128 kbits/sec), $t_r = t_f < 10\text{ ns}$, $V_{IH} = 3V$, $V_{IL} = 0V$, duty cycle = 50%.

Note 6: Generator characteristics for receiver input: $f = 64\text{ kHz}$ (128 kbits/sec), $t_r = t_f = 200\text{ ns}$, $V_{IH} = 3V$, $V_{IL} = -3V$, duty cycle = 50%.

Note 7: If receiver inputs are unconnected, receiver output is a logic high.

Note 8: Refer to typical curves. Driver output slew rate is measured from the $+3.0V$ to the $-3.0V$ level on the output waveform. Inputs not under test are connected to V_{CC} or GND. Slew rate is determined by load capacitance. To comply with a $30\text{ V}/\mu\text{s}$ maximum slew rate, a minimum load capacitance of 390 pF is recommended.

Parameter Measurement Information

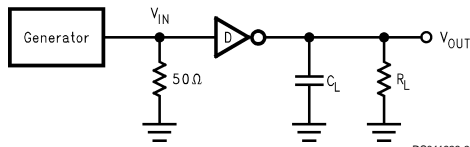

DS011938-3

FIGURE 1. Driver Propagation Delay and Transition Time Test Circuit (Note 5)

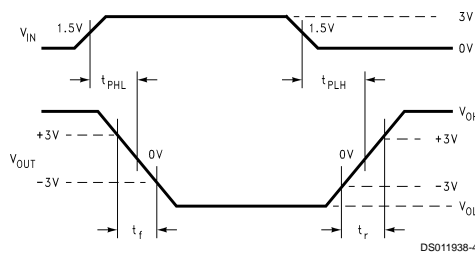

DS011938-4

FIGURE 2. Driver Propagation Delay and Transition Time Waveforms Slew Rate (SR) = 6V/(tr or tr)

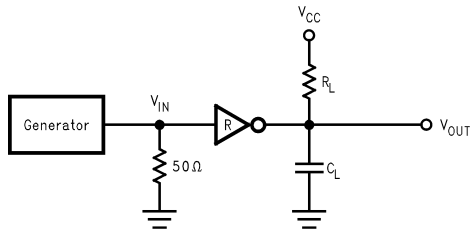

DS011938-5

FIGURE 3. Receiver Propagation Delay and Transition Time Test Circuit (Note 6)

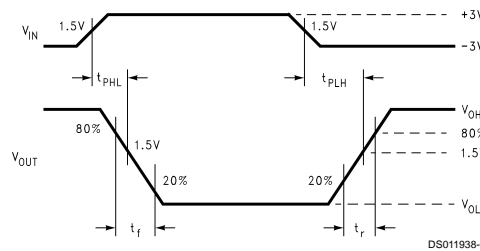

DS011938-6

FIGURE 4. Receiver Propagation Delay and Transition Time Waveform

Pin Descriptions

Pin #	Name	Description
13, 15, 16	D _{IN}	Driver Input Pins
5, 6, 8	D _{OUT}	Driver Output Pins, RS-232 Levels
2, 3, 4, 7, 9	R _{IN}	Receiver Input Pins, RS-232 Levels
12, 14, 17, 18, 19	R _{OUT}	Receiver Output Pins
11	GND	Ground
1	V ⁺	Positive Power Supply Pin (+9.0 ≤ V ⁺ ≤ +13.2)

Pin Descriptions (Continued)

Pin #	Name	Description
10	V ⁻	Negative Power Supply Pin (-9.0 ≤ V ⁻ ≤ -13.2)
20	V _{CC}	Positive Power Supply Pin (+5V ±5%)

Applications Information

In a typical Data Terminal Equipment (DTE) to Data Circuit-Terminating Equipment (DCE) 9-pin de-facto interface implementation, 2 data lines and 6 control lines are required. The data lines are TXD and RXD. The control lines are RTS, DTR, DSR, DCD, CTS, and RI.

The DS14185 is a 3 x 5 Driver/Receiver and offers a single chip solution for this DTE interface. As shown in *Figure 5*, this interface allows for direct flow-thru interconnect. For a more conservative design, the user may wish to insert ground traces between the signal lines to minimize cross talk.

LapLink COMPATIBILITY

The DS14185 can easily provide 128 kbps data rate under maximum driver load conditions of C_L = 2500 pF and R_L = 3 kΩ, while power supplies are:

$$V_{CC} = 4.75V, V^+ = 10.8V, V^- = -10.8V$$

MOUSE DRIVING

A typical mouse can be powered from the drivers. Two driver outputs connected in parallel and set to V_{OH} can be used to supply power to the V⁺ pin of the mouse. The third driver output is set to V_{OL} to sink the current from the V⁻ terminal. Refer to typical curves of V_{OUT}/I_{OUT}. Typical mouse specifications are:

10 mA at +6V
5 mA at -6V

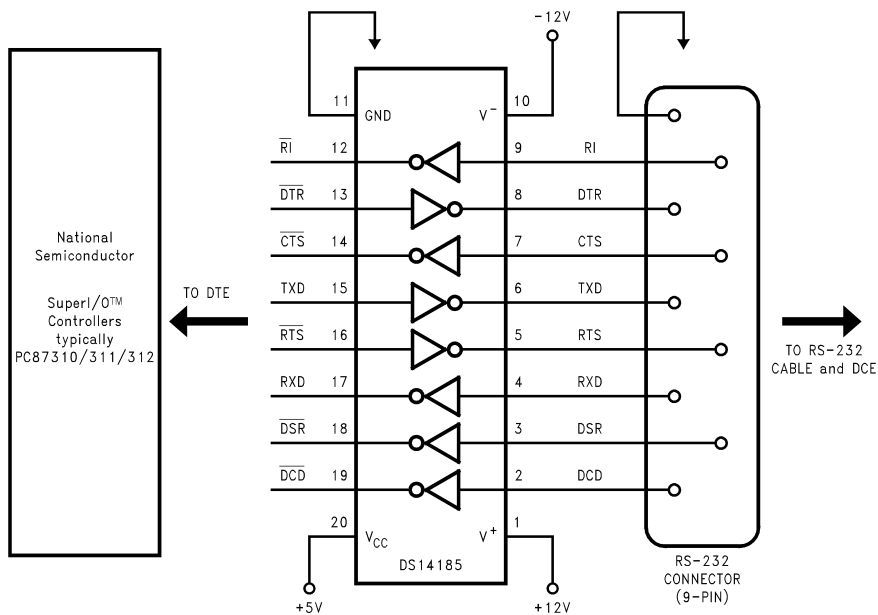
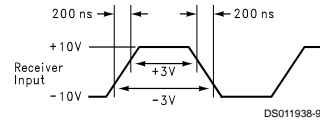
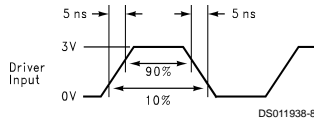

FIGURE 5. Typical DTE Application

DS011938-7

Typical Performance Characteristics



The above input waveforms were used to generate all Typical AC Characteristics.

Driver Output Slew Rate between +3V and -3V vs Load Capacitance
 Conditions: $V_{CC} = 5V$, $R_L = 5 k\Omega$, $T_A = 25^\circ C$,
 $f_{IN} = 64 \text{ kHz Square Wave}$

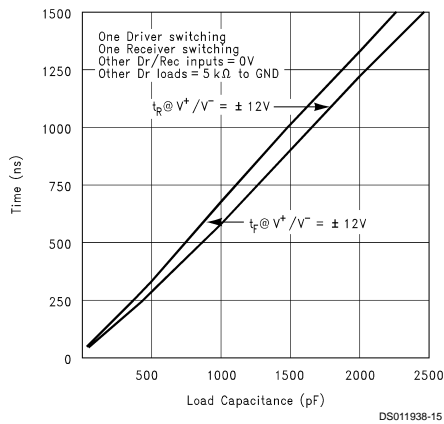

Driver Output Voltage vs Frequency and C_L
 Conditions: $V_{CC} = 5V$, $R_L = 5 k\Omega$, $T_A = 25^\circ C$

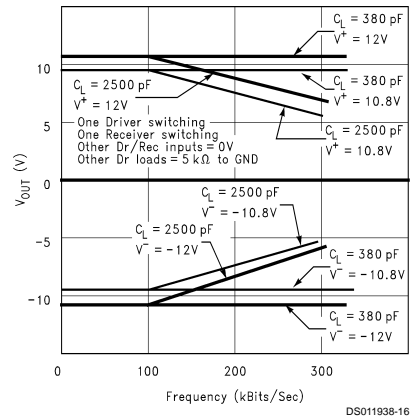

Supply Current vs Frequency and Driver C_L

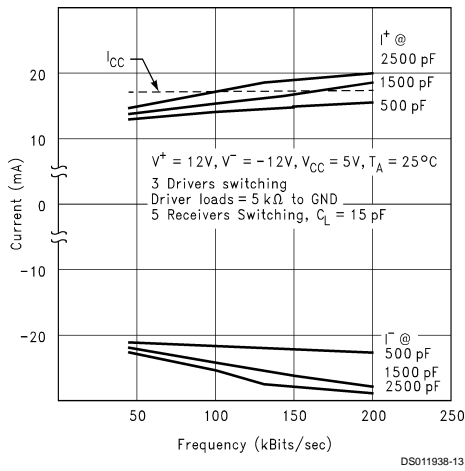

Supply Current vs Frequency and Driver C_L

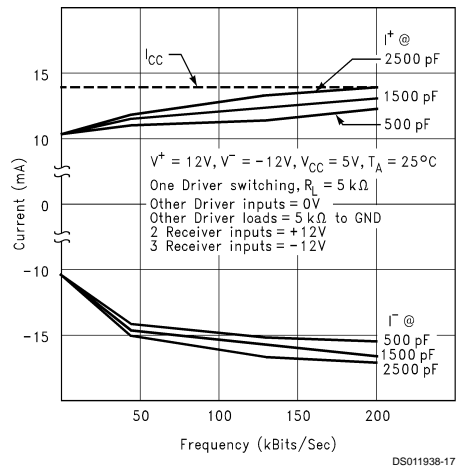

Typical Performance Characteristics (Continued)

Supply Current vs Frequency

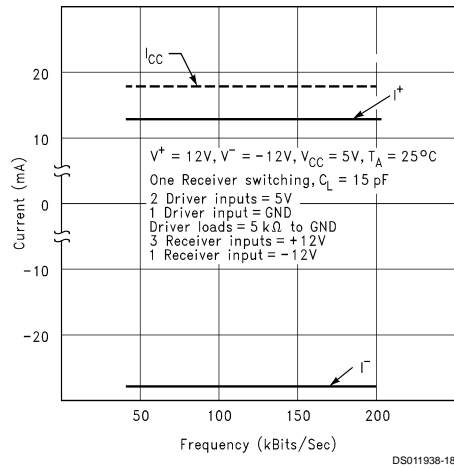

Driver Output Current vs Output Voltage

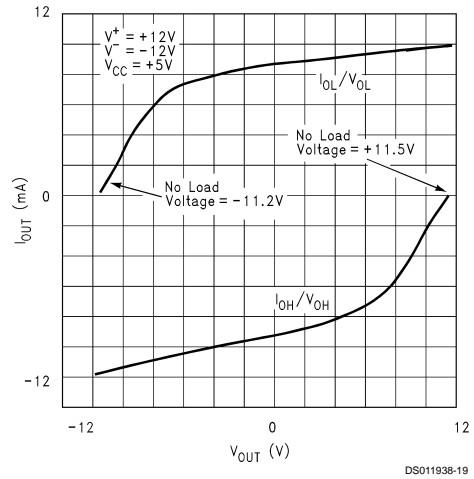

Physical Dimensions inches (millimeters) unless otherwise noted

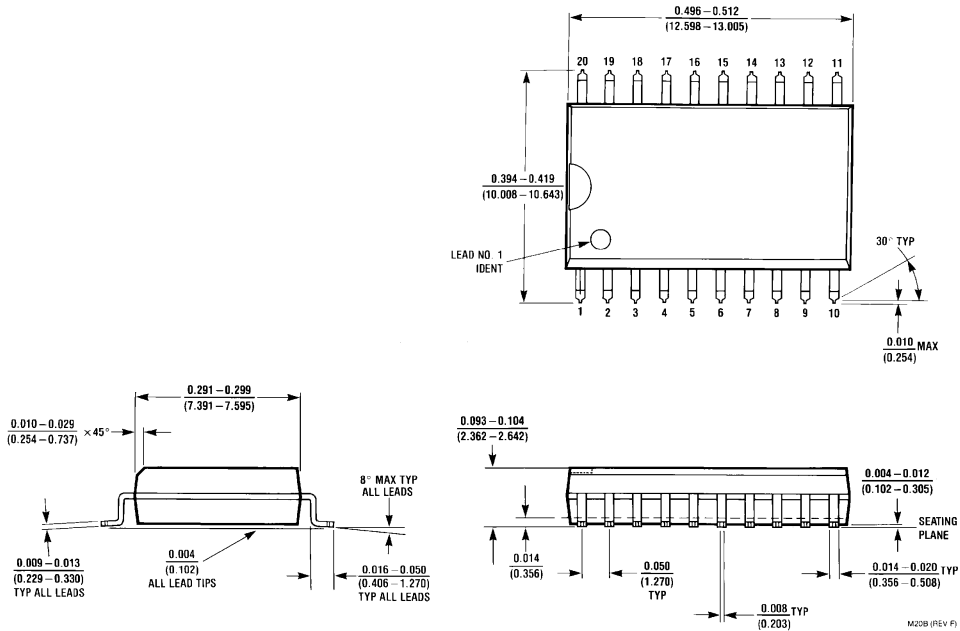

Small Outline Package
Order Number DS14185WM
NS Package M20B

LIFE SUPPORT POLICY

NATIONAL'S PRODUCTS ARE NOT AUTHORIZED FOR USE AS CRITICAL COMPONENTS IN LIFE SUPPORT DEVICES OR SYSTEMS WITHOUT THE EXPRESS WRITTEN APPROVAL OF THE PRESIDENT OF NATIONAL SEMICONDUCTOR CORPORATION. As used herein:

1. Life support devices or systems are devices or systems which, (a) are intended for surgical implant into the body, or (b) support or sustain life, and whose failure to perform when properly used in accordance with instructions for use provided in the labeling, can be reasonably expected to result in a significant injury to the user.
2. A critical component is any component of a life support device or system whose failure to perform can be reasonably expected to cause the failure of the life support device or system, or to affect its safety or effectiveness.



National Semiconductor Corporation
 Americas
 Tel: 1-800-272-9959
 Fax: 1-800-737-7018
 Email: support@nsc.com

www.national.com

National Semiconductor Europe
 Fax: +49 (0) 1 80-530 85 86
 Email: europe.support@nsc.com
 Deutsch Tel: +49 (0) 1 80-530 85 85
 English Tel: +49 (0) 1 80-532 78 32
 Français Tel: +49 (0) 1 80-532 93 58
 Italiano Tel: +49 (0) 1 80-534 16 80

National Semiconductor Asia Pacific Customer Response Group
 Tel: 65-2544466
 Fax: 65-2504466
 Email: sea.support@nsc.com

National Semiconductor Japan Ltd.
 Tel: 81-3-5639-7560
 Fax: 81-3-5639-7507