

DS2003

High Current/Voltage Darlington Drivers

General Description

The DS2003 is comprised of seven high voltage, high current NPN Darlington transistor pairs. All units feature common emitter, open collector outputs. To maximize their effectiveness, these units contain suppression diodes for inductive loads and appropriate emitter base resistors for leakage.

The DS2003 has a series base resistor to each Darlington pair, thus allowing operation directly with TTL or CMOS operating at supply voltages of 5.0V.

The DS2003 offers solutions to a great many interface needs, including solenoids, relays, lamps, small motors, and

LEDs. Applications requiring sink currents beyond the capability of a single output may be accommodated by paralleling the outputs.

Features

- Seven high gain Darlington pairs
- High output voltage ($V_{CE} = 50V$)
- High output current ($I_C = 350\text{ mA}$)
- TTL, PMOS, CMOS compatible
- Suppression diodes for inductive loads
- Extended temperature range

Connection Diagram

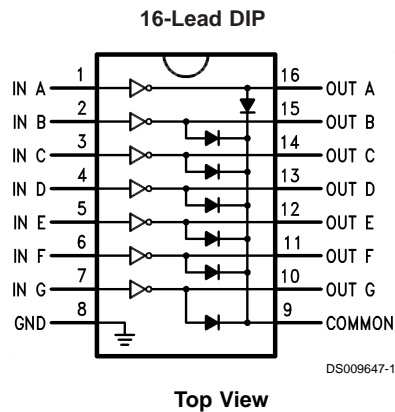

Order Numbers

N Package Number N16E	M Package Number M16A
DS2003TN	DS2003TM
DS2003CN	DS2003CM

Absolute Maximum Ratings (Note 1)

If Military/Aerospace specified devices are required, please contact the National Semiconductor Sales Office/ Distributors for availability and specifications.

Storage Temperature Range	-65°C to +150°C
Operating Temperature Range	
DS2003TN, DS2003TM	-40°C to +105°C
DS2003CN, DS2003CM	0°C to +85°C
Lead Temperature	
Soldering, 10 seconds	265°C

N16E Package	1330 mW
M16A Package	770 mW
Input Voltage	30V
Output Voltage	55V
Emitter-Base Voltage	6.0V
Continuous Collector Current	500 mA
Continuous Base Current	25 mA

Note: *Derate N16E package 13.3 mW/°C for T_A above 25°C. Derate M16A package 7.7 mW/°C for T_A above 25°C.

Maximum Power Dissipation* at T_A = 25°C

Electrical Characteristics

T_A = 25°C, unless otherwise specified (Note 2)

Symbol	Parameter	Conditions	Min	Typ	Max	Units
I _{CEX}	Output Leakage Current	T _A = 25°C, V _{CE} = 50V (Figure 1)			20	μA
		T _A = 85°C, V _{CE} = 50V (Figure 1) for DS2003CN, DS2003CM			100	
		T _A = 105°C, V _{CE} = 50V (Figure 1) for DS2003TN, DS2003TM			150	
V _{CE(Sat)}	Collector-Emitter Saturation Voltage	I _C = 350 mA, I _B = 500 μA (Figure 3) (Note 3)		1.25	1.6	V
		I _C = 200 mA, I _B = 350 μA (Figure 3)		1.1	1.3	
		I _C = 100 mA, I _B = 250 μA (Figure 3)		0.9	1.1	
I _{I(ON)}	Input Current	V _I = 3.85V (Figure 4)		0.93	1.35	mA
I _{I(OFF)}	Input Current (Note 4)	T _A = 85°C for DS2003CN, DS2003CM I _C = 500 μA (Figure 5)	50	100		μA
V _{I(ON)}	Input Voltage (Note 5)	V _{CE} = 2.0V, I _C = 200 mA (Figure 6)			2.4	V
		V _{CE} = 2.0V, I _C = 250 mA (Figure 6)			2.7	
		V _{CE} = 2.0V, I _C = 300 mA (Figure 6)			3.0	
C _I	Input Capacitance			15	30	pF
t _{PLH}	Turn-On Delay	0.5 V _I to 0.5 V _O			1.0	μs
t _{PHL}	Turn-Off Delay	0.5 V _I to 0.5 V _O			1.0	μs
I _R	Clamp Diode Leakage Current	V _R = 50V (Figure 7) T _A = 25°C			50	μA
		T _A = 85°C			100	μA
V _F	Clamp Diode Forward Voltage	I _F = 350 mA (Figure 8)		1.7	2.0	V

Note 1: "Absolute Maximum Ratings" are those values beyond which the safety of the device cannot be guaranteed. They are not meant to imply that the devices should be operated at these limits. The tables of "Electrical Characteristics" provide conditions for actual device operation.

Note 2: All limits apply to the complete Darlington series except as specified for a single device type.

Note 3: Under normal operating conditions these units will sustain 350 mA per output with V_{CE(Sat)} = 1.6V at 70°C with a pulse width of 20 ms and a duty cycle of 30%.

Note 4: The I_{I(OFF)} current limit guaranteed against partial turn-on of the output.

Note 5: The V_{I(ON)} voltage limit guarantees a minimum output sink current per the specified test conditions.

Typical Performance Characteristics

Collector Current vs Saturation Voltage

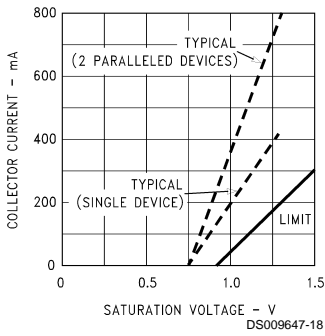

Collector Current vs Input Current

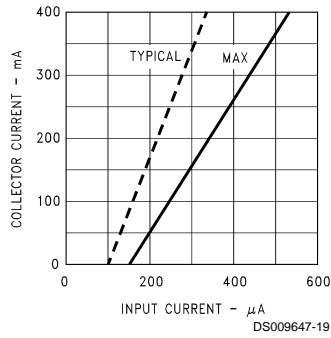

Input Current vs Input Voltage

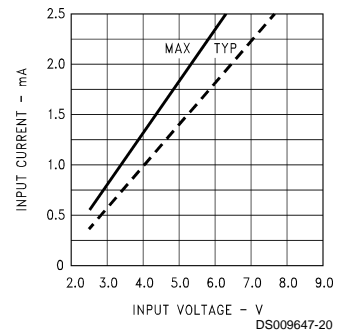

Peak Collector Current vs Duty Cycle and Number of Outputs (Molded Package)

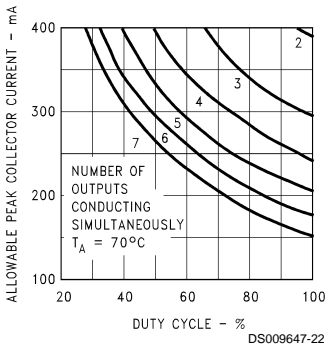

Peak Collector Current vs Duty Cycle and Number of Outputs (Ceramic Package)

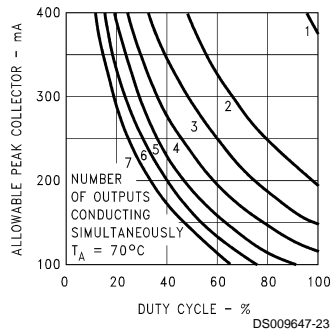

Equivalent Circuits

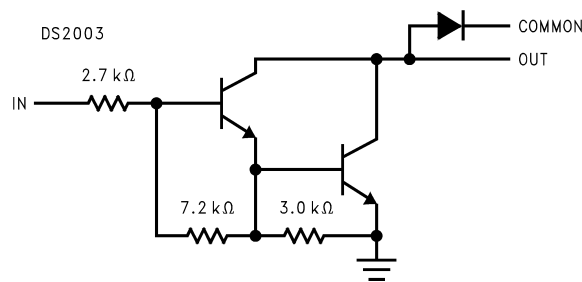

Test Circuits

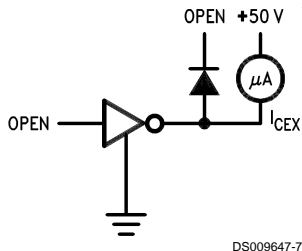

FIGURE 1.

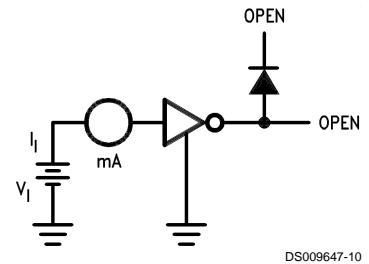

FIGURE 4.

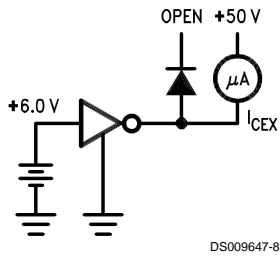

FIGURE 2.

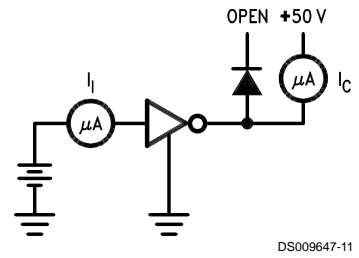

FIGURE 5.

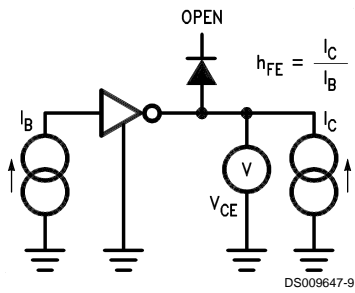

FIGURE 3.

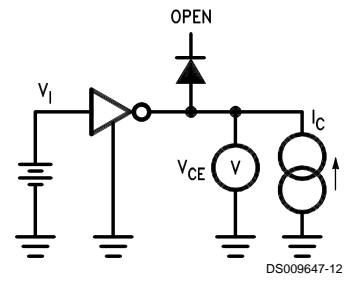

FIGURE 6.

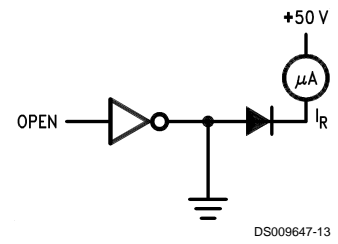

FIGURE 7.

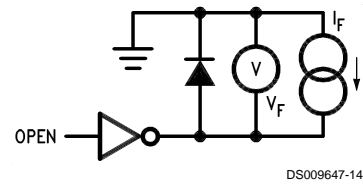
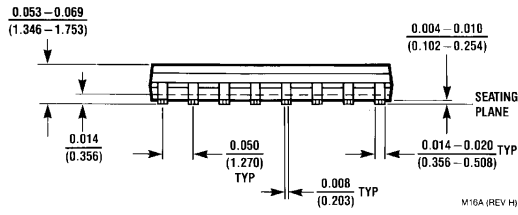
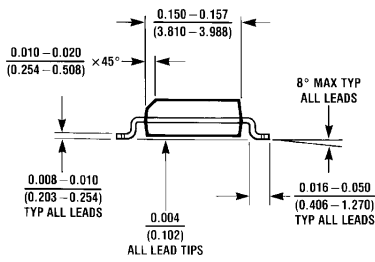
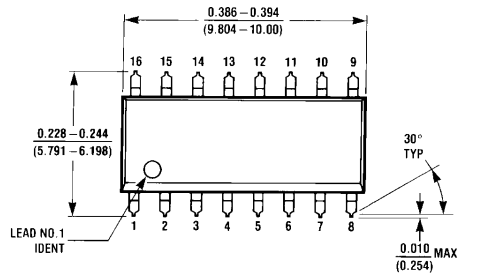
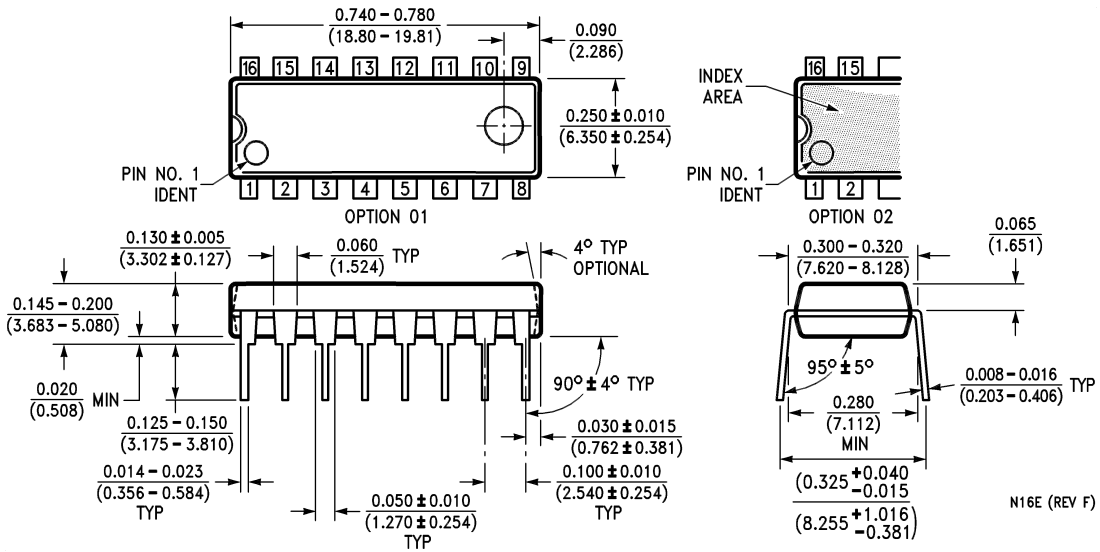

FIGURE 8.

Physical Dimensions inches (millimeters) unless otherwise noted



Surface Mount Package (M)
Order Number DS2003CM, DS2003TM
NS Package Number M16A



Molded Dual-In-Line Package (N)
Order Number DS2003CN, DS2003TN
NS Package Number N16E

Notes

LIFE SUPPORT POLICY

NATIONAL'S PRODUCTS ARE NOT AUTHORIZED FOR USE AS CRITICAL COMPONENTS IN LIFE SUPPORT DEVICES OR SYSTEMS WITHOUT THE EXPRESS WRITTEN APPROVAL OF THE PRESIDENT AND GENERAL COUNSEL OF NATIONAL SEMICONDUCTOR CORPORATION. As used herein:

1. Life support devices or systems are devices or systems which, (a) are intended for surgical implant into the body, or (b) support or sustain life, and whose failure to perform when properly used in accordance with instructions for use provided in the labeling, can be reasonably expected to result in a significant injury to the user.
2. A critical component is any component of a life support device or system whose failure to perform can be reasonably expected to cause the failure of the life support device or system, or to affect its safety or effectiveness.

 <p>National Semiconductor Corporation Americas Tel: 1-800-272-9959 Fax: 1-800-737-7018 Email: support@nsc.com</p> <p>www.national.com</p>	<p>National Semiconductor Europe</p> <p>Fax: +49 (0) 1 80-530 85 86 Email: europe.support@nsc.com</p> <p>Deutsch Tel: +49 (0) 1 80-530 85 85 English Tel: +49 (0) 1 80-532 78 32 Français Tel: +49 (0) 1 80-532 93 58 Italiano Tel: +49 (0) 1 80-534 16 80</p>	<p>National Semiconductor Asia Pacific Customer Response Group</p> <p>Tel: 65-2544466 Fax: 65-2504466 Email: sea.support@nsc.com</p>	<p>National Semiconductor Japan Ltd.</p> <p>Tel: 81-3-5639-7560 Fax: 81-3-5639-7507</p>
--	---	---	--