

DS34C87T CMOS Quad TRISTATE Differential Line Driver

General Description

The DS34C87T is a quad differential line driver designed for digital data transmission over balanced lines. The DS34C87T meets all the requirements of EIA standard RS-422 while retaining the low power characteristics of CMOS. This enables the construction of serial and terminal interfaces while maintaining minimal power consumption.

The DS34C87T accepts TTL or CMOS input levels and translates these to RS-422 output levels. This part uses special output circuitry that enables the individual drivers to power down without loading down the bus. This device has separate enable circuitry for each pair of the four drivers. The DS34C87T is pin compatible to the DS3487T.

All inputs are protected against damage due to electrostatic discharge by diodes to V_{CC} and ground.

Features

- TTL input compatible
- Typical propagation delays: 6 ns
- Typical output skew: 0.5 ns
- Outputs won't load line when $V_{CC} = 0V$
- Meets the requirements of EIA standard RS-422
- Operation from single 5V supply
- TRI-STATE outputs for connection to system buses
- Low quiescent current
- Available in surface mount

Connection and Logic Diagrams

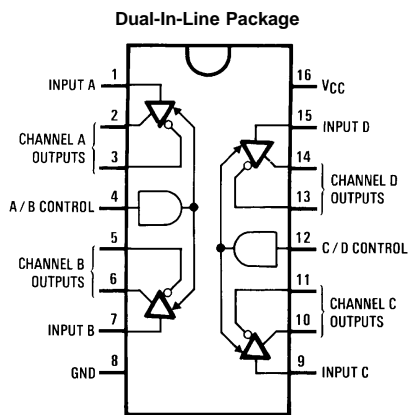

Top View
Order Number DS34C87TM or DS34C87TN
See NS Package Number M16A or N16E

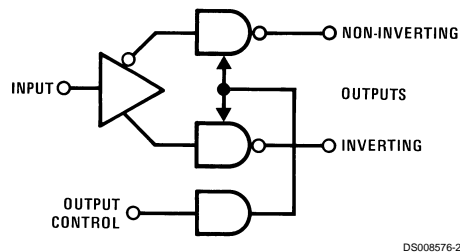

DS008576-2

Truth Table

Input	Control Input	Non-Inverting Output	Inverting Output
H	H	H	L
L	H	L	H
X	L	Z	Z

L = Low logic state
H = High logic state
X = Irrelevant
Z = TRI-STATE (high performance)

Absolute Maximum Ratings (Notes 1, 2)

If Military/Aerospace specified devices are required, please contact the National Semiconductor Sales Office/ Distributors for availability and specifications.

Supply Voltage (V_{CC})	-0.5 to 7.0V
DC Voltage (V_{IN})	-1.5 to V_{CC} +1.5V
DC Output Voltage (V_{OUT})	-0.5 to 7V
Clamp Diode Current (I_{IK} , I_{OK})	±20 mA
DC Output Current, per pin (I_{OUT})	±150 mA
DC V_{CC} or GND Current (I_{CC})	±150 mA
Storage Temperature Range (T_{STG})	-65°C to +150°C
Maximum Power Dissipation (P_D) @ 25°C (Note 3)	

Plastic "N" Package	1736 mW
SOIC Package	1226 mW
Lead Temperature (T_L) (Soldering 4 sec)	260°C

This device does not meet 2000V ESD rating. (Note 12)

Operating Conditions

	Min	Max	Units
Supply Voltage (V_{CC})	4.50	5.50	V
DC Input or Output Voltage (V_{IN} , V_{OUT})	0	V_{CC}	V
Operating Temperature Range (T_A) DS34C87T	-40	+85	°C
Input Rise or Fall Times (t_r , t_f)		500	ns

DC Electrical Characteristics (Note 4)

$V_{CC} = 5V \pm 10\%$ (unless otherwise specified)

Symbol	Parameter	Conditions	Min	Typ	Max	Units
V_{IH}	High Level Input Voltage		2.0			V
V_{IL}	Low Level Input Voltage				0.8	V
V_{OH}	High Level Output Voltage	$V_{IN} = V_{IH}$ or V_{IL} , $I_{OUT} = -20$ mA	2.5	3.4		V
V_{OL}	Low Level Output Voltage	$V_{IN} = V_{IH}$ or V_{IL} , $I_{OUT} = 48$ mA		0.3	0.5	V
V_T	Differential Output Voltage	$R_L = 100 \Omega$ (Note 5)	2.0	3.1		V
$ V_T - \bar{V}_T $	Difference In Differential Output	$R_L = 100 \Omega$ (Note 5)			0.4	V
V_{OS}	Common Mode Output Voltage	$R_L = 100 \Omega$ (Note 5)		2.0	3.0	V
$ V_{OS} - \bar{V}_{OS} $	Difference In Common Mode Output	$R_L = 100 \Omega$ (Note 5)			0.4	V
I_{IN}	Input Current	$V_{IN} = V_{CC}$, GND, V_{IH} , or V_{IL}			±1.0	µA
I_{CC}	Quiescent Supply Current	$I_{OUT} = 0$ µA, $V_{IN} = V_{CC}$ or GND $V_{IN} = 2.4V$ or $0.5V$ (Note 6)		200 0.8	500 2.0	µA mA
I_{OZ}	TRI-STATE™ Output Leakage Current	$V_{OUT} = V_{CC}$ or GND Control = V_{IL}		±0.5	±5.0	µA
I_{SC}	Output Short Circuit Current	$V_{IN} = V_{CC}$ or GND (Notes 5, 7)	-30		-150	mA
I_{OFF}	Power Off Output Leakage Current	$V_{CC} = 0V$ (Note 5)			100 -100	µA µA

Note 1: Absolute Maximum Ratings are those values beyond which the safety of the device cannot be guaranteed. They are not meant to imply that the device should be operated at these limits. The table of "Electrical Characteristics" provide conditions for actual device operation.

Note 2: Unless otherwise specified, all voltages are referenced to ground. All currents into device pins are positive; all currents out of device pins are negative.

Note 3: Ratings apply to ambient temperature at 25°C. Above this temperature derate N Package 13.89 mW/°C, and M Package 9.80 mW/°C.

Note 4: Unless otherwise specified, min/max limits apply across the -40°C to 85°C temperature range. All typicals are given for $V_{CC} = 5V$ and $T_A = 25°C$.

Note 5: See EIA Specification RS-422 for exact test conditions.

Note 6: Measured per input. All other inputs at V_{CC} or GND.

Note 7: This is the current sourced when a high output is shorted to ground. Only one output at a time should be shorted.

Switching Characteristics (Note 4)

$V_{CC} = 5V \pm 10\%$, $t_r, t_f \leq 6 \text{ ns}$ (Figures 1, 2, 3, 4)

Symbol	Parameter	Conditions	Min	Typ	Max	Units
t_{PLH}, t_{PHL}	Propagation Delay Input to Output	S1 Open		6	11	ns
Skew	(Note 8)	S1 Open		0.5	3	ns
t_{TLH}, t_{THL}	Differential Output Rise And Fall Times	S1 Open		6	10	ns
t_{PZH}	Output Enable Time	S1 Closed		12	25	ns
t_{PZL}	Output Enable Time	S1 Closed		13	26	ns
t_{PHZ}	Output Disable Time (Note 9)	S1 Closed		4	8	ns
t_{PLZ}	Output Disable Time (Note 9)	S1 Closed		6	12	ns
C_{PD}	Power Dissipation Capacitance (Note 10)			100		pF
C_{IN}	Input Capacitance			6		pF

Note 8: Skew is defined as the difference in propagation delays between complementary outputs at the 50% point.

Note 9: Output disable time is the delay from the control input being switched to the output transistors turning off. The actual disable times are less than indicated due to the delay added by the RC time constant of the load.

Note 10: C_{PD} determines the no load dynamic power consumption, $P_D = C_{PD} V_{CC}^2 f + I_{CC} V_{CC}$, and the no load dynamic current consumption, $I_S = C_{PD} V_{CC} f + I_{CC}$.

Comparison Table of Switching Characteristics into "LS-Type" Load (Note 11)

$V_{CC} = 5V$, $T_A = +25^\circ C$, $t_r \leq 6 \text{ ns}$, $t_f \leq 6 \text{ ns}$ (Figures 4, 5, 6, 7, 8, 9)

Symbol	Parameter	Conditions	DS34C87		DS3487		Units
			Typ	Max	Typ	Max	
t_{PLH}, t_{PHL}	Propagation Delay Input to Output		6	10	10	15	ns
Skew	(Note 8)		1.5	2.0			ns
t_{THL}, t_{TLH}	Differential Output Rise and Fall Times		4	7	10	15	ns
t_{PHZ}	Output Disable Time (Note 9)	$C_L = 50 \text{ pF}$, $R_L = 200\Omega$, S1 Closed, S2 Closed	8	11	17	25	ns
t_{PLZ}	Output Disable Time (Note 9)	$C_L = 50 \text{ pF}$, $R_L = 200\Omega$, S1 Closed, S2 Closed	7	10	15	25	ns
t_{PZH}	Output Enable Time	$C_L = 50 \text{ pF}$, $R_L = \infty$, S1 Open, S2 Closed	11	19	11	25	ns
t_{PZL}	Output Enable Time	$C_L = 50 \text{ pF}$, $R_L = 200\Omega$, S1 Closed, S2 Open	14	21	15	25	ns

Note 11: This table is provided for comparison purposes only. The values in this table for the DS34C87 reflect the performance of the device but are not tested or guaranteed.

Note 12: ESD Rating: HBM (1.5 kΩ, 100 pF)

Inputs $\geq 1500V$
Outputs $\geq 1000V$
EIAJ (0Ω, 200 pF)
All Pins $\geq 350V$

AC Test Circuit and Switching Time Waveforms

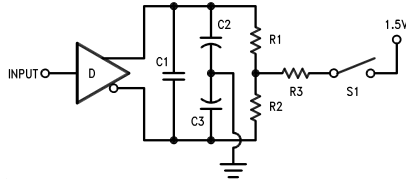

DS008576-3

Note: $C1 = C2 = C3 = 40 \text{ pF}$ (including Probe and Jig Capacitance), $R1 = R2 = 50\Omega$, $R3 = 500\Omega$

FIGURE 1. AC Test Circuit

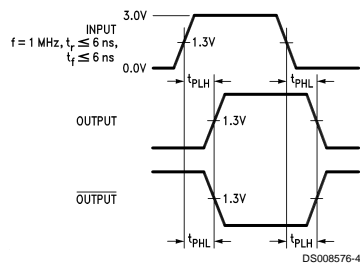

DS008576-4

FIGURE 2. Propagation Delays

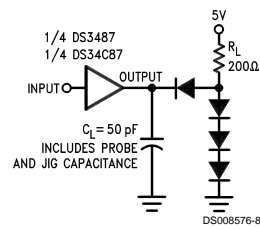

DS008576-8

FIGURE 5. Propagation Delays Test Circuit for "LS-Type" Load

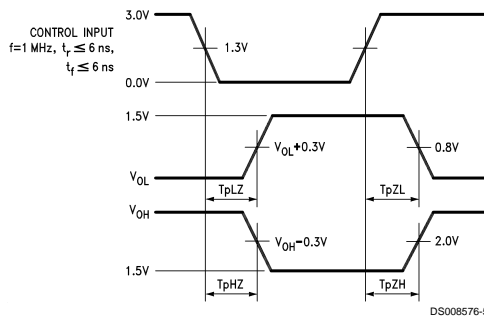

DS008576-5

FIGURE 3. Enable and Disable Times

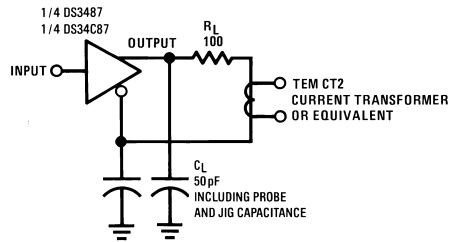

DS008576-6

FIGURE 6. Differential Rise and Fall Times Test Circuit for "LS-Type" Load

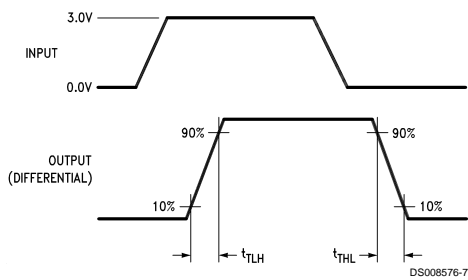

DS008576-7

Input pulse; $f = 1 \text{ MHz}$, 50%, $t_r \leq 6 \text{ ns}$, $t_f \leq 6 \text{ ns}$

FIGURE 4. Differential Rise and Fall Times

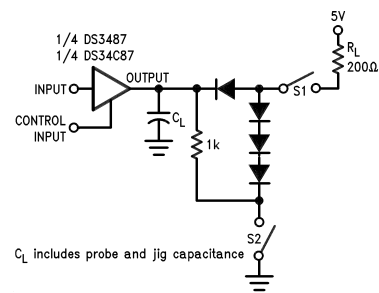

DS008576-9

FIGURE 7. Load Enable and Disable Times Test Circuit for "LS-Type" Load

AC Test Circuit and Switching Time Waveforms (Continued)

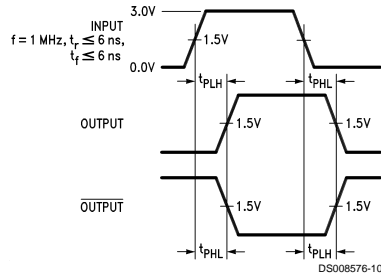

FIGURE 8. Load Propagation Delays for "LS-Type" Load

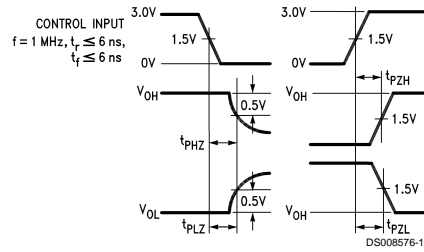
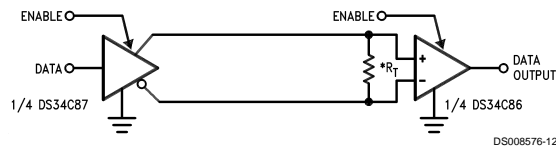
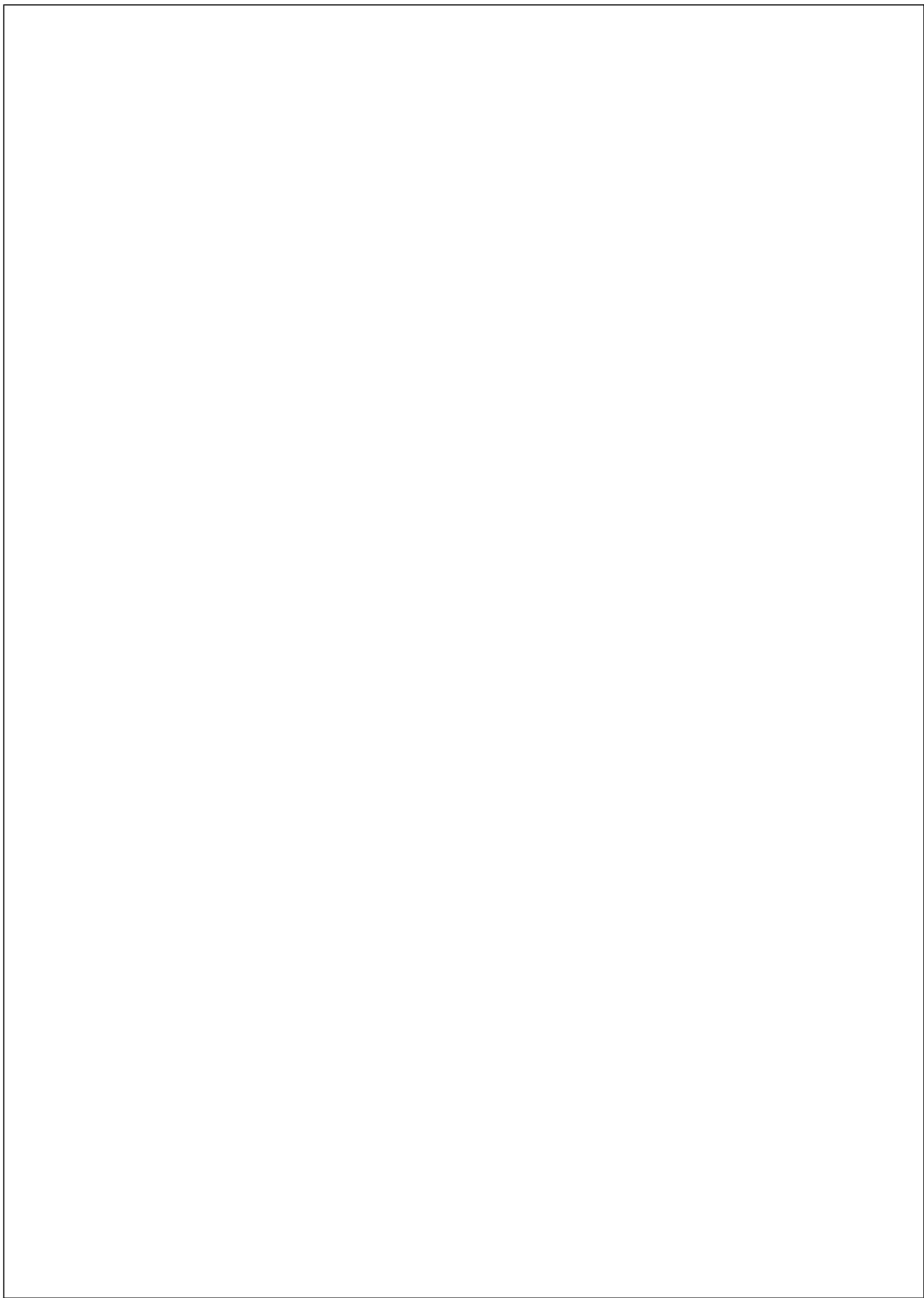

FIGURE 9. Load Enable and Disable Times for "LS-Type" Load

Typical Applications



* R_T is optional although highly recommended to reduce reflection.



Physical Dimensions inches (millimeters) unless otherwise noted

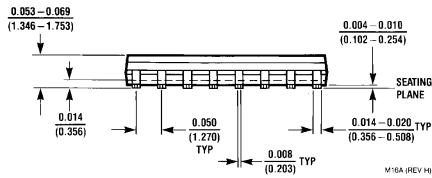
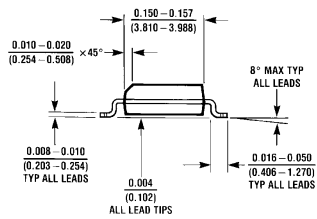
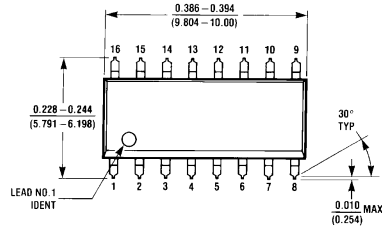

**16-Lead Molded Package
Small Outline (M)
Order Number DS34C87TM
NS Package Number M16A**

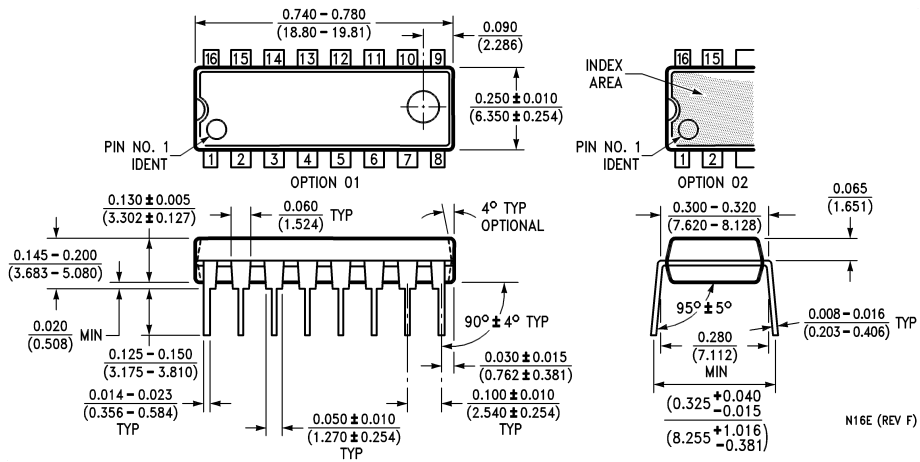

**16-Lead Molded Dual-In-Line Package (N)
Order Number DS34C87TN
NS Package Number N16E**

LIFE SUPPORT POLICY

NATIONAL'S PRODUCTS ARE NOT AUTHORIZED FOR USE AS CRITICAL COMPONENTS IN LIFE SUPPORT DEVICES OR SYSTEMS WITHOUT THE EXPRESS WRITTEN APPROVAL OF THE PRESIDENT OF NATIONAL SEMICONDUCTOR CORPORATION. As used herein:

1. Life support devices or systems are devices or systems which, (a) are intended for surgical implant into the body, or (b) support or sustain life, and whose failure to perform when properly used in accordance with instructions for use provided in the labeling, can be reasonably expected to result in a significant injury to the user.
2. A critical component in any component of a life support device or system whose failure to perform can be reasonably expected to cause the failure of the life support device or system, or to affect its safety or effectiveness.



National Semiconductor Corporation
Americas
Tel: 1-800-272-9959
Fax: 1-800-737-7018
Email: support@nsc.com

www.national.com

National Semiconductor Europe
Fax: +49 (0) 1 80-530 85 86
Email: europe.support@nsc.com
Deutsch Tel: +49 (0) 1 80-530 85 85
English Tel: +49 (0) 1 80-532 78 32
Français Tel: +49 (0) 1 80-532 93 58
Italiano Tel: +49 (0) 1 80-534 16 80

National Semiconductor Asia Pacific Customer Response Group
Tel: 65-2544466
Fax: 65-2504466
Email: sea.support@nsc.com

National Semiconductor Japan Ltd.
Tel: 81-3-5620-6175
Fax: 81-3-5620-6179