

## DS8922/DS8922A/DS8923A TRI-STATE® RS-422 Dual Differential Line Driver and Receiver Pairs

### General Description

The DS8922/22A and DS8923A are Dual Differential Line Driver and Receiver pairs. These devices are designed specifically for applications meeting the ST506, ST412 and ESDI Disk Drive Standards. In addition, the devices meet the requirements of the EIA Standard RS-422.

These devices offer an input sensitivity of 200 mV over a  $\pm 7V$  common mode operating range. Hysteresis is incorporated (typically 70 mV) to improve noise margin for slowly changing input waveforms. An input fail-safe circuit is provided such that if the receiver inputs are open the output assumes the logical one state.

The DS8922A and DS8923A drivers are designed to provide unipolar differential drive to twisted pair or parallel wire transmission lines. Complementary outputs are logically ANDed and provide an output skew of 0.5 ns (typ.) with propagation delays of 12 ns.

Both devices feature TRI-STATE outputs. The DS8922/22A have independent control functions common to a driver and receiver pair. The DS8923A has separate driver and receiver control functions.

Power up/down circuitry is featured which will TRI-STATE the outputs and prevent erroneous glitches on the transmission lines during system power up or power down operation.

The DS8922/22A and DS8923A are designed to be compatible with TTL and CMOS.

### Features

- 12 ns typical propagation delay
- Output skew —  $\pm 0.5$  ns typical
- Meets the requirements of EIA Standard RS-422
- Complementary Driver Outputs
- High differential or common-mode input voltage ranges of  $\pm 7V$
- $\pm 0.2V$  receiver sensitivity over the input voltage range
- Receiver input fail-safe circuitry
- Receiver input hysteresis — 70 mV typical
- Glitch free power up/down
- TRI-STATE outputs

### Connection Diagrams

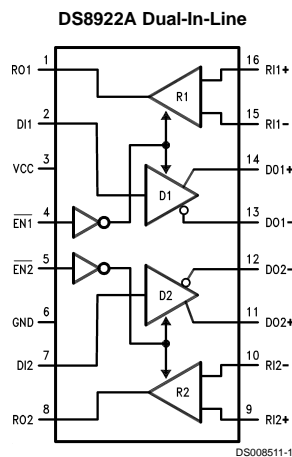

**Order Number DS8922M, DS8922N,  
DS8922AM or DS8922AN  
See NS Package Number M16A or N16E**

TRI-STATE® is a registered trademark of National Semiconductor Corp.

## Connection Diagrams (Continued)

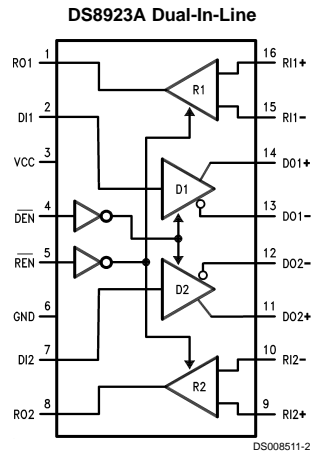

Order Number DS8923AM, DS8923AN,  
See NS Package Number M16A or N16E

## Truth Tables

### DS8922/22A

$\overline{EN1}$	$\overline{EN2}$	R01	R02	D01	D02
0	0	ACTIVE	ACTIVE	ACTIVE	ACTIVE
1	0	HI-Z	ACTIVE	HI-Z	ACTIVE
0	1	ACTIVE	HI-Z	ACTIVE	HI-Z
1	1	HI-Z	HI-Z	HI-Z	HI-Z

### DS8923A

$\overline{DEN}$	$\overline{REN}$	R01	R02	D01	D02
0	0	ACTIVE	ACTIVE	ACTIVE	ACTIVE
1	0	ACTIVE	ACTIVE	HI-Z	HI-Z
0	1	HI-Z	HI-Z	ACTIVE	ACTIVE
1	1	HI-Z	HI-Z	HI-Z	HI-Z

### Absolute Maximum Ratings (Note 1)

If Military/Aerospace specified devices are required, please contact the National Semiconductor Sales Office/Distributors for availability and specifications.

Supply Voltage	7V
Drive Input Voltage	-0.5V to +7V
Output Voltage	5.5V
Receiver Output Sink Current	50 mA
Receiver Input Voltage	±10V
Differential Input Voltage	±12V
Maximum Package Power Dissipation @ +25°C	
M Package	1300 mW

N Package	1450 mW
Derate M Package	10.4 mW/°C above +25°C
Derate N Package	11.6 mW/°C above +25°C
Storage Temperature Range	-65°C to +165°C
Lead Temp. (Soldering, 4 seconds)	260°C

### Recommended Operating Conditions

	Min	Max	Units
Supply Voltage	4.5	5.5	V
Temperature (T <sub>A</sub> )	0	70	°C

### DS8922/22A and DS8923A Electrical Characteristics (Notes 2, 3, 4)

Symbol	Conditions	Min	Typ	Max	Units
<b>RECEIVER</b>					
V <sub>TH</sub>	-7V ≤ V <sub>CM</sub> ≤ +7V	-200	±35	+200	mV
V <sub>HYST</sub>	-7V ≤ V <sub>CM</sub> ≤ +7V	15	70		mV
R <sub>IN</sub>	V <sub>IN</sub> = -7V, +7V (Other Input = GND)	4.0	6.0		kΩ
I <sub>IN</sub>	V <sub>IN</sub> = 10V			3.25	mA
	V <sub>IN</sub> = -10V			-3.25	mA
V <sub>OH</sub>	V <sub>CC</sub> = MIN, I <sub>OH</sub> = -400 μA	2.5			V
V <sub>OL</sub>	V <sub>CC</sub> = MAX, I <sub>OL</sub> = 8 mA			0.5	V
I <sub>SC</sub>	V <sub>CC</sub> = MAX, V <sub>OUT</sub> = 0V	-15		-100	mA
<b>DRIVER</b>					
V <sub>OH</sub>	V <sub>CC</sub> = MIN, I <sub>OH</sub> = -20 mA	2.5			V
V <sub>OL</sub>	V <sub>CC</sub> = MIN, I <sub>OL</sub> = +20 mA			0.5	V
I <sub>OFF</sub>	V <sub>CC</sub> = 0V, V <sub>OUT</sub> = 5.5V			100	μA
VT  -  VT'				0.4	V
VT		2.0			V
V <sub>OS</sub> - V <sub>OS</sub> '				0.4	V
I <sub>SC</sub>	V <sub>CC</sub> = MAX, V <sub>OUT</sub> = 0V	-30		-150	mA
<b>DRIVER and RECEIVER</b>					
I <sub>OZ</sub> TRI-STATE Leakage	V <sub>CC</sub> = MAX	V <sub>OUT</sub> = 2.5V		50	μA
		V <sub>OUT</sub> = 0.4V		-50	μA
I <sub>CC</sub>	V <sub>CC</sub> = MAX	ACTIVE		76	mA
		TRI-STATE		78	mA
<b>DRIVER and ENABLE INPUTS</b>					
V <sub>IH</sub>		2.0			V
V <sub>IL</sub>				0.8	V
I <sub>IL</sub>	V <sub>CC</sub> = MAX, V <sub>IN</sub> = 0.4V		-40	-200	μA
I <sub>IH</sub>	V <sub>CC</sub> = MAX, V <sub>IN</sub> = 2.7V			20	μA
I <sub>I</sub>	V <sub>CC</sub> = MAX, V <sub>IN</sub> = 7.0V			100	μA
V <sub>CL</sub>	V <sub>CC</sub> = MIN, I <sub>IN</sub> = -18 mA			-1.5	V

## Receiver Switching Characteristics

(Figures 1, 2, 3)

Parameter	Conditions	Min	Typ	Max		Units
				8922	8922A/23A	
T <sub>pLH</sub>	CL = 30 pF		12	22.5	20	ns
T <sub>pHL</sub>	CL = 30 pF		12	22.5	20	ns
T <sub>pLH</sub> - T <sub>pHL</sub>	CL = 30 pF		0.5	5	3.5	ns
Skew (Channel to Channel)	CL = 30 pF		0.5	3.0	2.0	ns
T <sub>pLZ</sub>	CL = 15 pF S2 Open		15			ns
T <sub>pHZ</sub>	CL = 15 pF S1 Open		15			ns
T <sub>pZL</sub>	CL = 30 pF S2 Open		20			ns
T <sub>pZH</sub>	CL = 30 pF S1 Open		20			ns

## Driver Switching Characteristics

Parameter	Conditions	Min	Typ	Max		Units
				8922	8922A/23A	
<b>SINGLE ENDED CHARACTERISTICS</b> (Figures 4, 5, 6, 8)						
T <sub>pLH</sub>	CL = 30 pF		12	15	15	ns
T <sub>pHL</sub>	CL = 30 pF		12	15	15	ns
T <sub>TLH</sub>	CL = 30 pF		5	10	10	ns
T <sub>THL</sub>	CL = 30 pF		5	10	10	ns
T <sub>pLH</sub> - T <sub>pHL</sub>	CL = 30 pF		0.5			ns
Skew	CL = 30 pF (Note 5)		0.5	5	3.5	ns
Skew (Channel to Channel)			0.5	3.0	2.0	ns
T <sub>pLZ</sub>	CL = 30 pF		15			ns
T <sub>pHZ</sub>	CL = 30 pF		15			ns
T <sub>pZL</sub>	CL = 30 pF		20			ns
T <sub>pZH</sub>	CL = 30 pF		20			ns
<b>DIFFERENTIAL SWITCHING CHARACTERISTICS</b> (Note 6), (Figure 4)						
T <sub>pLH</sub>	CL = 30 pF		12	15	15	ns
T <sub>pHL</sub>	CL = 30 pF		12	15	15	ns
T <sub>pLH</sub> - T <sub>pHL</sub>	CL = 30 pF		0.5	6.0	2.75	ns

**Note 1:** "Absolute Maximum Ratings" are those values beyond which the safety of the device cannot be guaranteed. They are not meant to imply that the device should be operated at these limits. The Table of "Electrical Characteristics" provides conditions for actual device operation.

**Note 2:** All currents into device pins are shown as positive values; all currents out of the device are shown as negative; all voltages are referenced to ground unless otherwise specified. All values shown as max or min are classified on absolute value basis.

**Note 3:** All typical values are V<sub>CC</sub> = 5V, T<sub>A</sub> = 25°C.

**Note 4:** Only one output at a time should be shorted.

**Note 5:** Difference between complementary outputs at the 50% point.

**Note 6:** Differential Delays are defined as calculated results from single ended rise and fall time measurements. This approach in establishing AC performance specifications has been taken due to limitations of available Automatic Test Equipment (ATE).

The calculated ATE results assume a linear transition between measurement points and are a result of the following equations:

$$T_{cp} = \frac{(T_{fb} \times T_{rb}) - (T_{ra} \times T_{fa})}{T_{rb} - T_{ra} - T_{fa} + T_{fb}}$$

Where:

T<sub>cp</sub> = Crossing Point

T<sub>ra</sub>, T<sub>rb</sub>, T<sub>fa</sub> and T<sub>fb</sub> are time measurements with respect to the input.

## Switching Time Waveforms

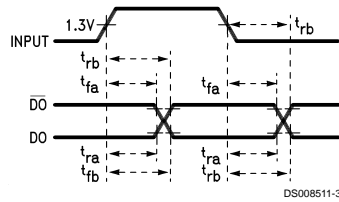

## AC Test Circuits and Switching Waveforms

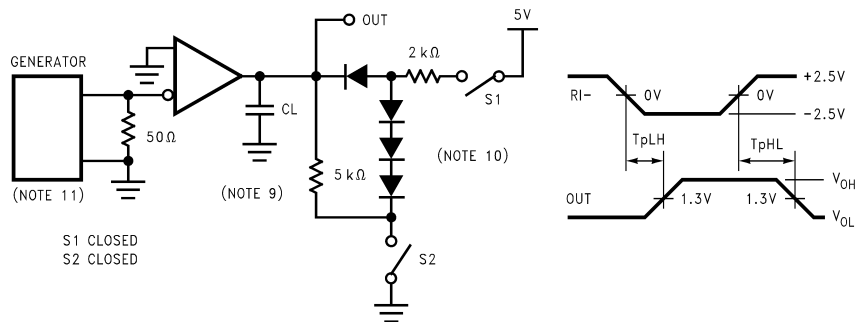

FIGURE 1.

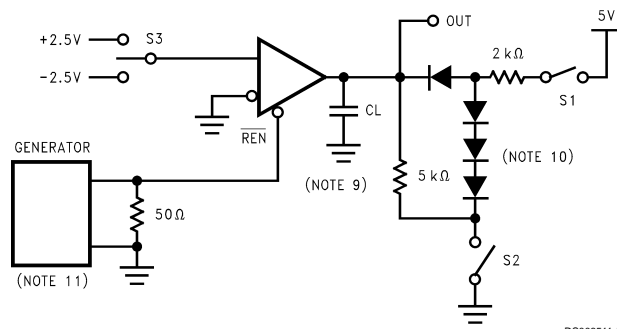
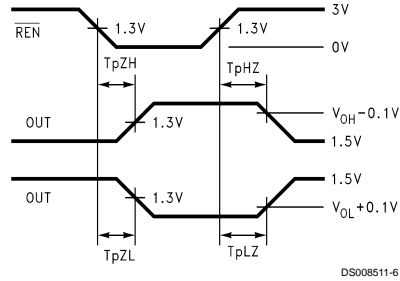

FIGURE 2.

## AC Test Circuits and Switching Waveforms (Continued)



DS008511-6

	S1	S2	S3
$T_{PLZ}$	Closed	Open	+2.5V
$T_{PHZ}$	Open	Closed	-2.5V
$T_{PZL}$	Closed	Open	+2.5V
$T_{PZH}$	Open	Closed	-2.5V

FIGURE 3.

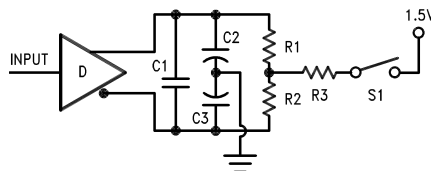

NOTE:  $C1=C2=C3=30\text{ pF}$ ,  $R1=R2=50\ \Omega$ ,  $R3=500\ \Omega$ .

DS008511-7

FIGURE 4.

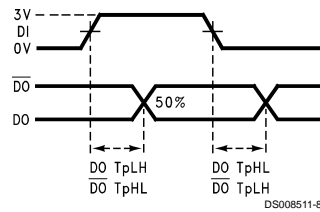

DS008511-8

FIGURE 5.

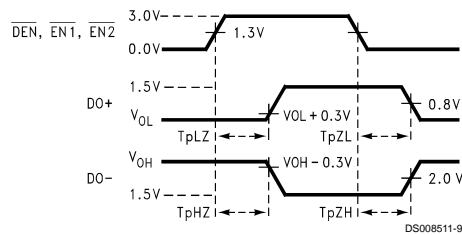

DS008511-9

FIGURE 6.

## AC Test Circuits and Switching Waveforms (Continued)

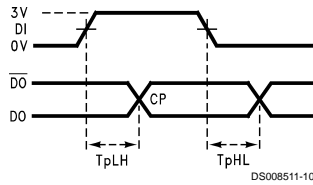

FIGURE 7.

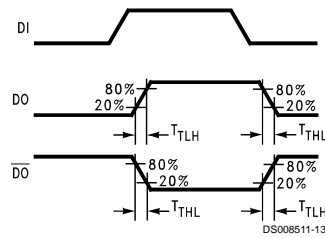
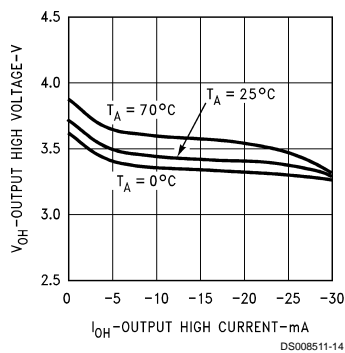

FIGURE 8.

## Typical Performance Characteristics (DS8923A)

Driver  $V_{OH}$  vs  $I_{OH}$  vs Temperature



Driver  $V_{OH}$  vs  $I_{OH}$  vs  $V_{CC}$

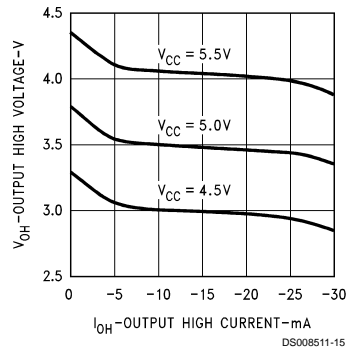

Driver  $V_{OL}$  vs  $I_{OL}$  vs Temperature

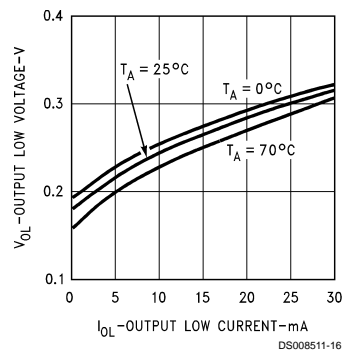

Driver  $V_{OL}$  vs  $I_{OL}$  vs  $V_{CC}$

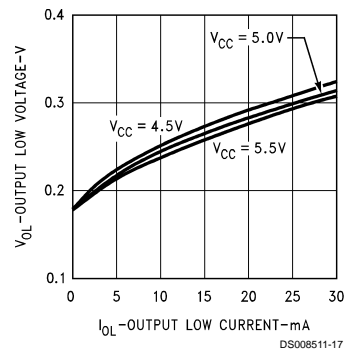

## Typical Performance Characteristics (DS8923A) (Continued)

Receiver  $V_{OH}$  vs  $I_{OH}$  vs Temperature

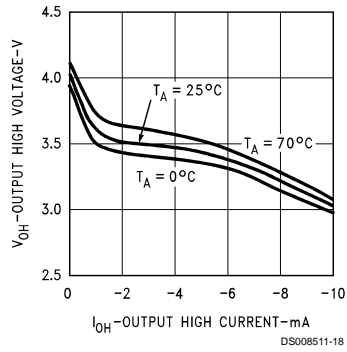

Receiver  $V_{OH}$  vs  $I_{OH}$  vs  $V_{CC}$

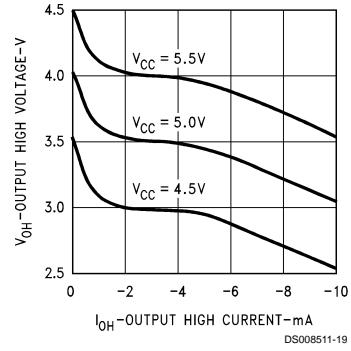

Receiver  $V_{OL}$  vs  $I_{OL}$  vs Temperature

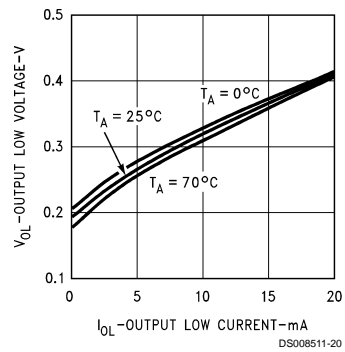

Receiver  $V_{OL}$  vs  $I_{OL}$  vs  $V_{CC}$

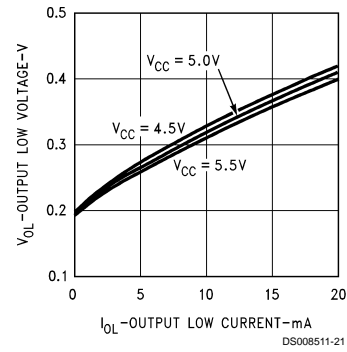

Driver Differential Propagation Delay vs Temperature

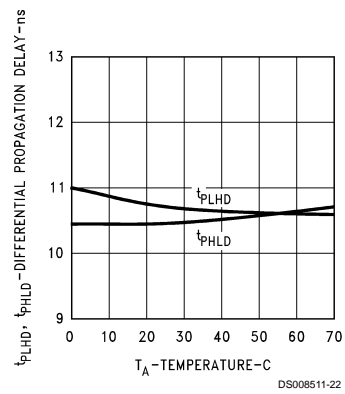

Driver Differential Propagation Delay vs  $V_{CC}$

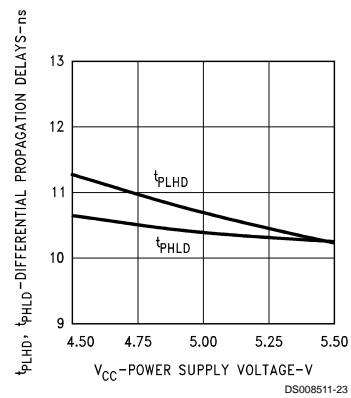



## Typical Performance Characteristics (DS8923A) (Continued)

**Receiver Propagation Delay vs Temperature**

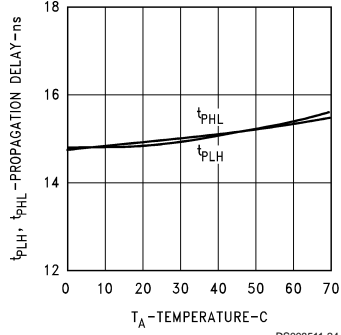

**Receiver Propagation Delay vs V<sub>CC</sub>**

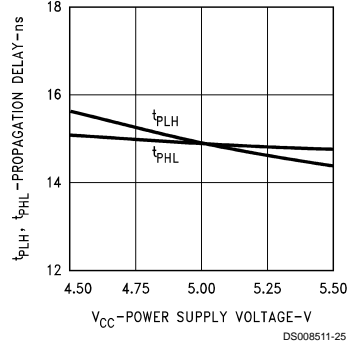

**Driver V<sub>OD</sub> vs Temperature**

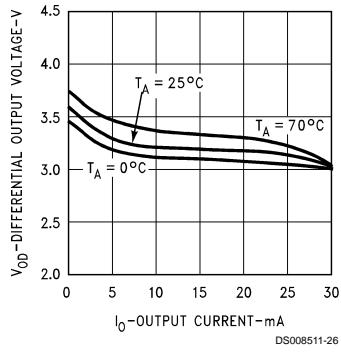

**Driver V<sub>OD</sub> vs V<sub>CC</sub>**

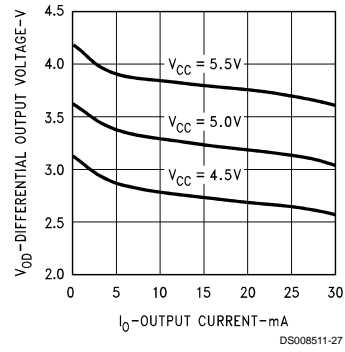

**Driver V<sub>OD</sub> vs R<sub>L</sub>**

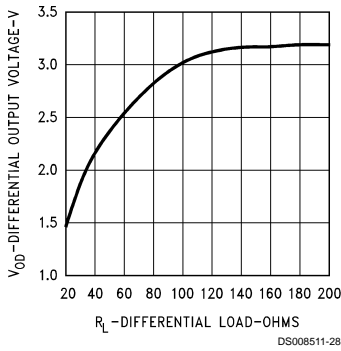

**Driver Differential Transition Time vs Temperature**

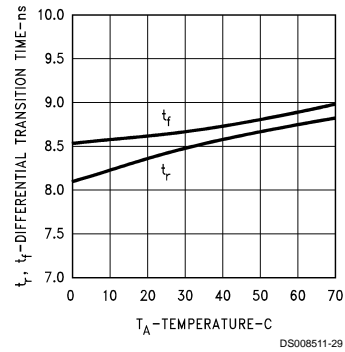

## Typical Performance Characteristics (DS8923A) (Continued)

**Driver Differential Transition Time vs  $V_{CC}$**

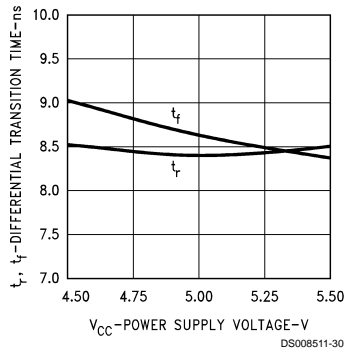

**Supply Current vs Temperature**

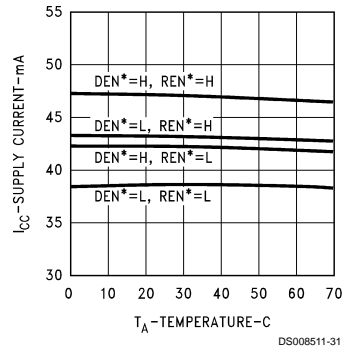

**Supply Current vs  $V_{CC}$**

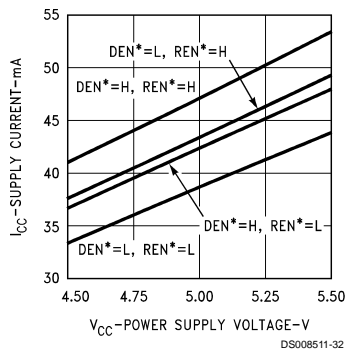

**$I_{CC}$  vs Driver Switching Frequency**

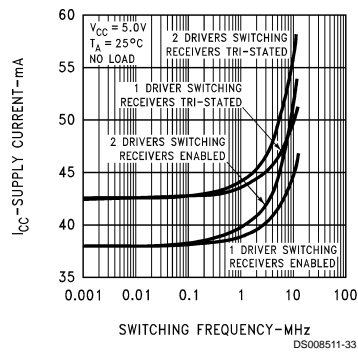

**Driver Short Circuit Current vs Temperature**

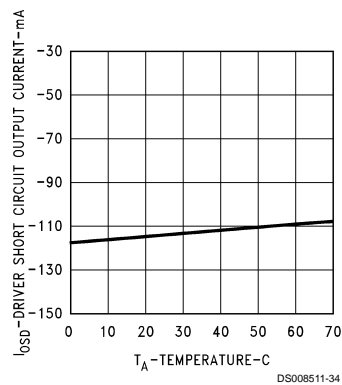

**Driver Short Circuit Current vs  $V_{CC}$**

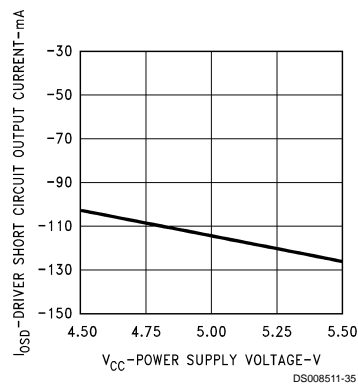

## Typical Performance Characteristics (DS8923A) (Continued)

Receiver Short Circuit Current vs Temperature

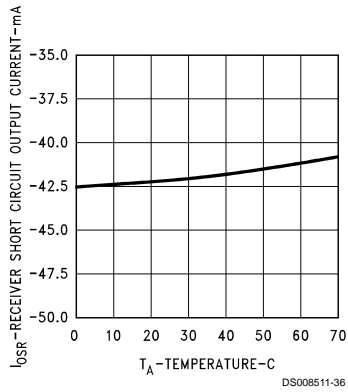

DS008511-36

Receiver Short Circuit Current vs V<sub>CC</sub>

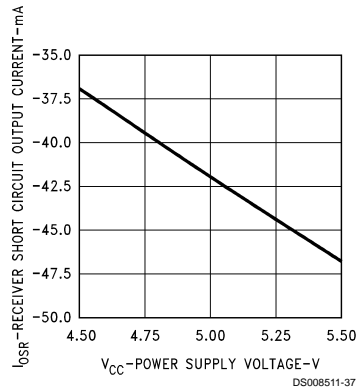

DS008511-37

## Typical Applications

ESDI Application

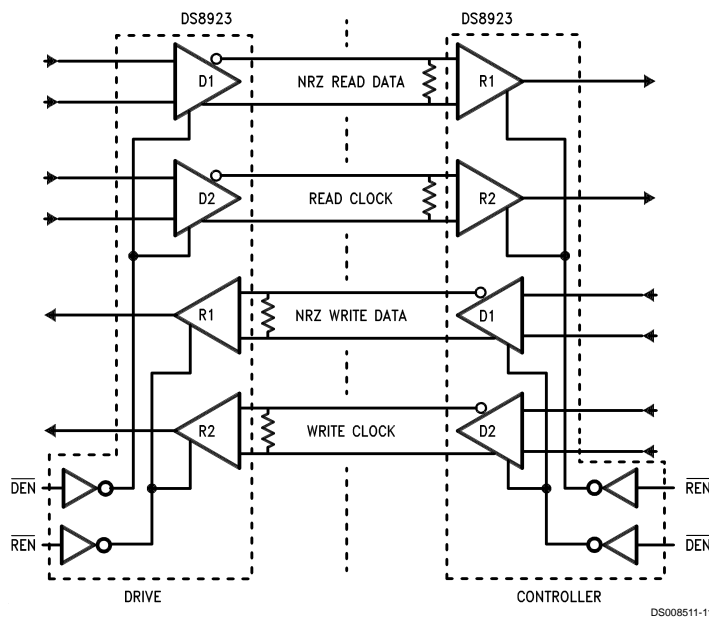

DS008511-11

**Typical Applications** (Continued)

**ST504 and ST412 Applications**

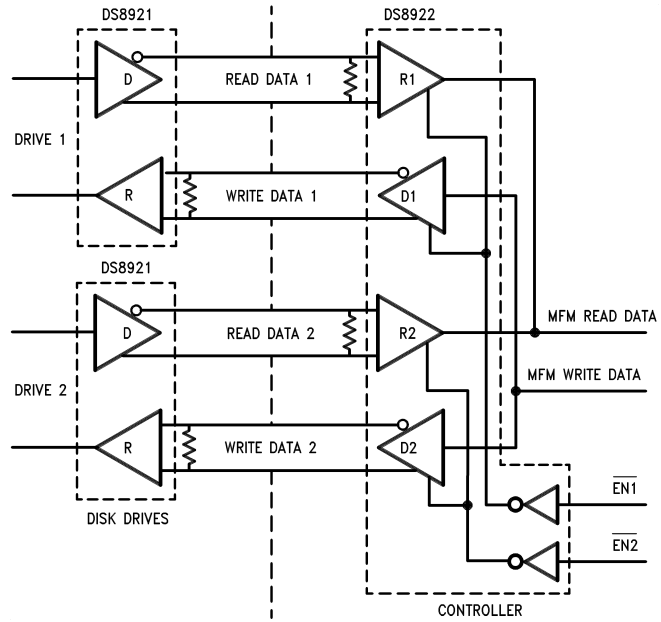

DS008511-12

**Physical Dimensions** inches (millimeters) unless otherwise noted

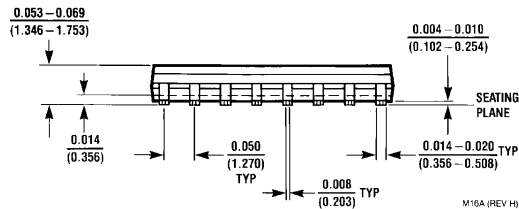
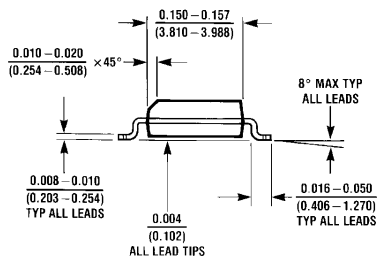
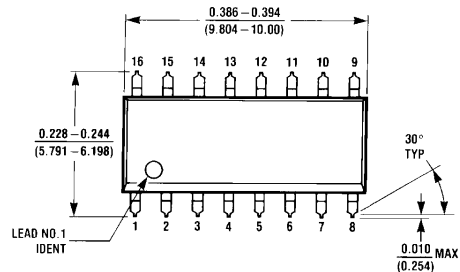

M16A (REV H)

**SO Package (M)**  
Order Number DS8922M, DS8922AM, or DS8923AM  
NS Package Number M16A

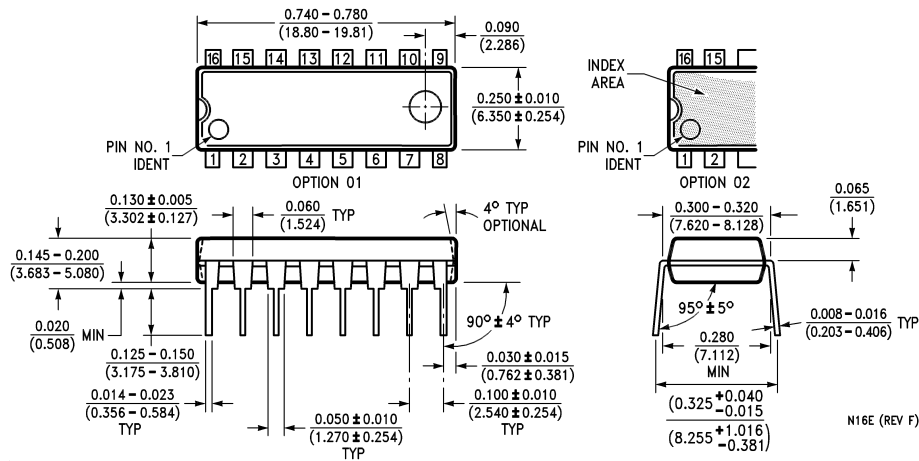

N16E (REV F)

**Molded Dual-In-Line Package (N)**  
Order Number DS8922N, DS8922AN, or DS8923AN  
NS Package Number N16E

**LIFE SUPPORT POLICY**

NATIONAL'S PRODUCTS ARE NOT AUTHORIZED FOR USE AS CRITICAL COMPONENTS IN LIFE SUPPORT DEVICES OR SYSTEMS WITHOUT THE EXPRESS WRITTEN APPROVAL OF THE PRESIDENT OF NATIONAL SEMICONDUCTOR CORPORATION. As used herein:

1. Life support devices or systems are devices or systems which, (a) are intended for surgical implant into the body, or (b) support or sustain life, and whose failure to perform when properly used in accordance with instructions for use provided in the labeling, can be reasonably expected to result in a significant injury to the user.
2. A critical component in any component of a life support device or system whose failure to perform can be reasonably expected to cause the failure of the life support device or system, or to affect its safety or effectiveness.



**National Semiconductor Corporation**  
Americas  
Tel: 1-800-272-9959  
Fax: 1-800-737-7018  
Email: support@nsc.com

[www.national.com](http://www.national.com)

**National Semiconductor Europe**  
Fax: +49 (0) 1 80-530 85 86  
Email: europe.support@nsc.com  
Deutsch Tel: +49 (0) 1 80-530 85 85  
English Tel: +49 (0) 1 80-532 78 32  
Français Tel: +49 (0) 1 80-532 93 58  
Italiano Tel: +49 (0) 1 80-534 16 80

**National Semiconductor Asia Pacific Customer Response Group**  
Tel: 65-2544466  
Fax: 65-2504466  
Email: sea.support@nsc.com

**National Semiconductor Japan Ltd.**  
Tel: 81-3-5620-6175  
Fax: 81-3-5620-6179