

DS90C032 LVDS Quad CMOS Differential Line Receiver

General Description

The DS90C032 is a quad CMOS differential line receiver designed for applications requiring ultra low power dissipation and high data rates. The device is designed to support data rates in excess of 155.5 Mbps (77.7 MHz) utilizing Low Voltage Differential Signaling (LVDS) technology.

The DS90C032 accepts low voltage (350 mV) differential input signals and translates them to CMOS (TTL compatible) output levels. The receiver supports a TRI-STATE® function that may be used to multiplex outputs. The receiver also supports OPEN, shorted and terminated (100Ω) input Fail-safe. Receiver output will be HIGH for all fail-safe conditions.

The DS90C032 and companion line driver (DS90C031) provide a new alternative to high power psuedo-ECL devices for high speed point-to-point interface applications.

Features

- >155.5 Mbps (77.7 MHz) switching rates
- Accepts small swing (350 mV) differential signal levels
- Ultra low power dissipation
- 600 ps maximum differential skew (5V, 25°C)
- 6.0 ns maximum propagation delay
- Industrial operating temperature range
- Military operating temperature range option
- Available in surface mount packaging (SOIC) and (LCC)
- Pin compatible with DS26C32A, MB570 (PECL) and 41LF (PECL)
- Supports OPEN, short and terminated input fail-safe
- Compatible with IEEE 1596.3 SCI LVDS standard
- Conforms to ANSI/TIA/EIA-644 LVDS standard
- Available to Standard Microcircuit Drawing (SMD) 5962-95834

Connection Diagrams

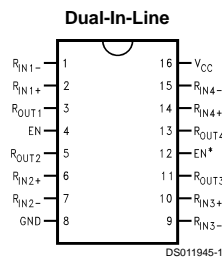

Order Number
DS90C032TM
See NS Package Number M16A

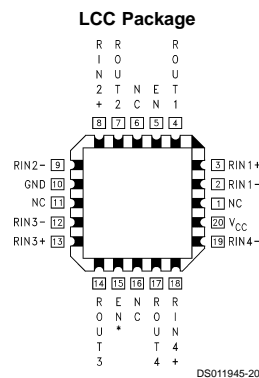

Order Number
DS90C032E-QML
See NS Package Number E20A
For complete Military Specifications,
refer to appropriate SMD or MDS.

Functional Diagram and Truth Tables

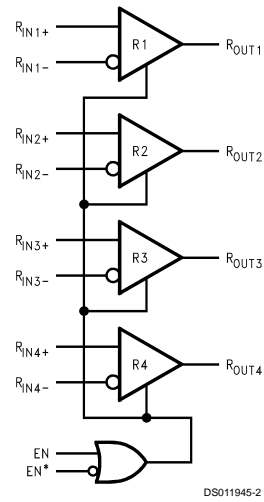

RECEIVER

ENABLES		INPUTS	OUTPUT
EN	EN*	$R_{IN+} - R_{IN-}$	R_{OUT}
L	H	X	Z
All other combinations of ENABLE inputs		$V_{ID} \geq 0.1V$	H
		$V_{ID} \leq -0.1V$	L
		Full Fail-safe OPEN/SHORT or Terminated	H

Absolute Maximum Ratings (Note 1)

If Military/Aerospace specified devices are required, please contact the National Semiconductor Sales Office/Distributors for availability and specifications.

Supply Voltage (V_{CC})	-0.3V to +6V
Input Voltage (R_{IN+} , R_{IN-})	-0.3V to ($V_{CC} + 0.3V$)
Enable Input Voltage (EN, EN*)	-0.3V to ($V_{CC} + 0.3V$)
Output Voltage (R_{OUT})	-0.3V to ($V_{CC} + 0.3V$)
Maximum Package Power Dissipation @ +25°C	
M Package	1025 mW
E Package	1830 mW
Derate M Package	8.2 mW/°C above +25°C
Derate E Package	12.2 mW/°C above +25°C
Storage Temperature Range	-65°C to +150°C
Lead Temperature Range Soldering (4 sec.)	+260°C

Maximum Junction Temperature (DS90C032T) +150°C

Maximum Junction Temperature (DS90C032E) +175°C

ESD Rating (Note 7)
(HBM, 1.5 kΩ, 100 pF) ≥ 3,500V
(EIAJ, 0 Ω, 200 pF) ≥ 250V

Recommended Operating Conditions

	Min	Typ	Max	Units
Supply Voltage (V_{CC})	+4.5	+5.0	+5.5	V
Receiver Input Voltage	GND		2.4	V
Operating Free Air Temperature (T_A)				
DS90C032T	-40	+25	+85	°C
DS90C032E	-55	+25	+125	°C

Electrical Characteristics

Over Supply Voltage and Operating Temperature ranges, unless otherwise specified. (Note 2)

Symbol	Parameter	Conditions	Pin	Min	Typ	Max	Units
V_{TH}	Differential Input High Threshold	$V_{CM} = +1.2V$	R_{IN+}			+100	mV
V_{TL}	Differential Input Low Threshold		R_{IN-}	-100			mV
I_{IN}	Input Current	$V_{IN} = +2.4V$ $V_{IN} = 0V$	$V_{CC} = 5.5V$	-10	±1	+10	μA
V_{OH}	Output High Voltage	$I_{OH} = -0.4 mA$, $V_{ID} = +200 mV$ $I_{OH} = -0.4 mA$, Input terminated	DS90C032T	R_{OUT}	3.8	4.9	V
V_{OL}	Output Low Voltage	$I_{OL} = 2 mA$, $V_{ID} = -200 mV$			0.07	0.3	V
I_{OS}	Output Short Circuit Current	Enabled, $V_{OUT} = 0V$ (Note 8)		-15	-60	-100	mA
I_{OZ}	Output TRI-STATE Current	Disabled, $V_{OUT} = 0V$ or V_{CC}		-10	±1	+10	μA
V_{IH}	Input High Voltage		EN, EN*	2.0			V
V_{IL}	Input Low Voltage					0.8	V
I_I	Input Current			-10	±1	+10	μA
V_{CL}	Input Clamp Voltage	$I_{CL} = -18 mA$		-1.5	-0.8		V
I_{CC}	No Load Supply Current Receivers Enabled	EN, EN* = V_{CC} or GND, Inputs Open	DS90C032T DS90C032E	V_{CC}	3.5	10	mA
		EN, EN* = 2.4 or 0.5, Inputs Open			3.5	11	mA
					3.7	11	mA
I_{CCZ}	No Load Supply Current Receivers Disabled	EN = GND, EN* = V_{CC} Inputs Open	DS90C032T DS90C032E		3.5	10	mA
					3.5	11	mA

Switching Characteristics

$V_{CC} = +5.0V$, $T_A = +25^\circ C$ DS90C032T (Notes 3, 4, 5, 9)

Symbol	Parameter	Conditions	Min	Typ	Max	Units
t_{PHLD}	Differential Propagation Delay High to Low	$C_L = 5\text{ pF}$ $V_{ID} = 200\text{ mV}$ (Figure 1 and Figure 2)	1.5	3.40	5.0	ns
t_{PLHD}	Differential Propagation Delay Low to High		1.5	3.48	5.0	ns
t_{SKD}	Differential Skew $ t_{PHLD} - t_{PLHD} $		0	80	600	ps
t_{SK1}	Channel-to-Channel Skew (Note 5)		0	0.6	1.0	ns
t_{TLH}	Rise Time			0.5	2.0	ns
t_{THL}	Fall Time			0.5	2.0	ns
t_{PHZ}	Disable Time High to Z	$R_L = 2\text{ k}\Omega$		10	15	ns
t_{PLZ}	Disable Time Low to Z	$C_L = 10\text{ pF}$ (Figure 3 and Figure 4)		10	15	ns
t_{PZH}	Enable Time Z to High			4	10	ns
t_{PZL}	Enable Time Z to Low			4	10	ns

Switching Characteristics

$V_{CC} = +5.0V \pm 10\%$, $T_A = -40^\circ C$ to $+85^\circ C$ DS90C032T (Notes 3, 4, 5, 6, 9)

Symbol	Parameter	Conditions	Min	Typ	Max	Units
t_{PHLD}	Differential Propagation Delay High to Low	$C_L = 5\text{ pF}$ $V_{ID} = 200\text{ mV}$ (Figure 1 and Figure 2)	1.0	3.40	6.0	ns
t_{PLHD}	Differential Propagation Delay Low to High		1.0	3.48	6.0	ns
t_{SKD}	Differential Skew $ t_{PHLD} - t_{PLHD} $		0	0.08	1.2	ns
t_{SK1}	Channel-to-Channel Skew (Note 5)		0	0.6	1.5	ns
t_{SK2}	Chip to Chip Skew (Note 6)				5.0	ns
t_{TLH}	Rise Time			0.5	2.5	ns
t_{THL}	Fall Time			0.5	2.5	ns
t_{PHZ}	Disable Time High to Z	$R_L = 2\text{ k}\Omega$		10	20	ns
t_{PLZ}	Disable Time Low to Z	$C_L = 10\text{ pF}$ (Figure 3 and Figure 4)		10	20	ns
t_{PZH}	Enable Time Z to High			4	15	ns
t_{PZL}	Enable Time Z to Low			4	15	ns

Switching Characteristics

$V_{CC} = +5.0V \pm 10\%$, $T_A = -55^\circ C$ to $+125^\circ C$ DS90C032E (Notes 3, 4, 5, 6, 9, 10)

Symbol	Parameter	Conditions	Min	Typ	Max	Units
t_{PHLD}	Differential Propagation Delay High to Low	$C_L = 20\text{ pF}$ $V_{ID} = 200\text{ mV}$ (Figure 1 and Figure 2)	1.0	3.40	8.0	ns
t_{PLHD}	Differential Propagation Delay Low to High		1.0	3.48	8.0	ns
t_{SKD}	Differential Skew $ t_{PHLD} - t_{PLHD} $		0	0.08	3.0	ns
t_{SK1}	Channel-to-Channel Skew (Note 5)		0	0.6	3.0	ns
t_{SK2}	Chip to Chip Skew (Note 6)				7.0	ns
t_{PHZ}	Disable Time High to Z	$R_L = 2\text{ k}\Omega$		10	20	ns
t_{PLZ}	Disable Time Low to Z	$C_L = 10\text{ pF}$ (Figure 3 and Figure 4)		10	20	ns
t_{PZH}	Enable Time Z to High			4	20	ns
t_{PZL}	Enable Time Z to Low			4	20	ns

Parameter Measurement Information

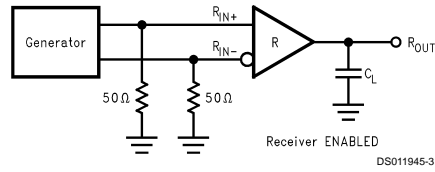

FIGURE 1. Receiver Propagation Delay and Transition Time Test Circuit

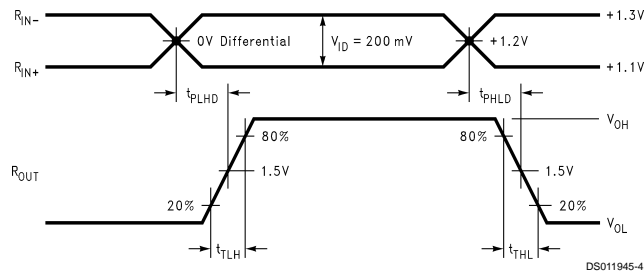
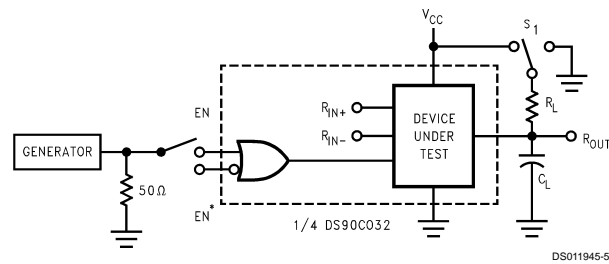

FIGURE 2. Receiver Propagation Delay and Transition Time Waveforms



C_L includes load and test jig capacitance.
 $S_1 = V_{CC}$ for t_{PZL} and t_{PLZ} measurements.
 $S_1 = GND$ for t_{PZH} and t_{PHZ} measurements.

FIGURE 3. Receiver TRI-STATE Delay Test Circuit

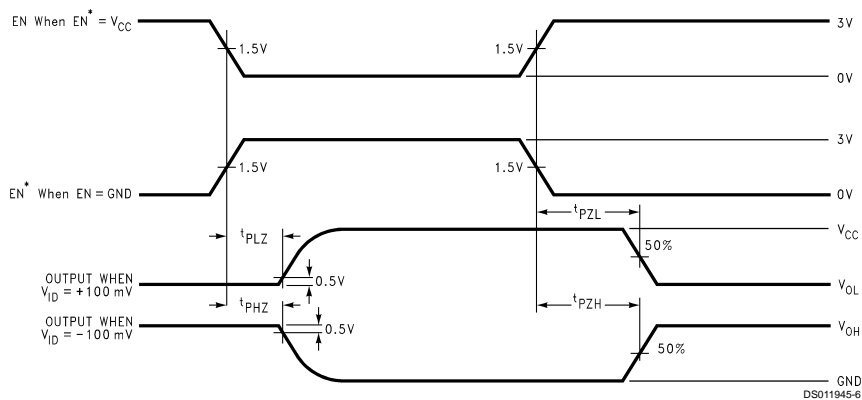

FIGURE 4. Receiver TRI-STATE Delay Waveforms

Typical Application

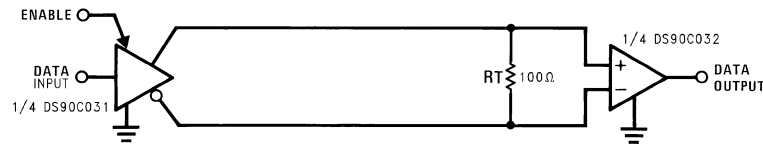

FIGURE 5. Point-to-Point Application

Applications Information

LVDS drivers and receivers are intended to be primarily used in an uncomplicated point-to-point configuration as is shown in *Figure 5*. This configuration provides a clean signaling environment for the quick edge rates of the drivers. The receiver is connected to the driver through a balanced media which may be a standard twisted pair cable, a parallel pair cable, or simply PCB traces. Typically the characteristic impedance of the media is in the range of 100Ω. A termination resistor of 100Ω should be selected to match the media, and is located as close to the receiver input pins as possible. The termination resistor converts the current sourced by the driver into a voltage that is detected by the receiver. Other configurations are possible such as a multi-receiver configuration, but the effects of a mid-stream connector(s), cable stub(s), and other impedance discontinuities as well as ground shifting, noise margin limits, and total termination loading must be taken into account.

The DS90C032 differential line receiver is capable of detecting signals as low as 100 mV, over a ±1V common-mode range centered around +1.2V. This is related to the driver offset voltage which is typically +1.2V. The driven signal is centered around this voltage and may shift ±1V around this center point. The ±1V shifting may be the result of a ground potential difference between the driver's ground reference and the receiver's ground reference, the common-mode effects of coupled noise, or a combination of the two. Both receiver input pins should honor their specified operating input voltage range of 0V to +2.4V (measured from each pin to ground), exceeding these limits may turn on the ESD protection circuitry which will clamp the bus voltages.

Receiver Fail-Safe:

The LVDS receiver is a high gain, high speed device that amplifies a small differential signal (20mV) to CMOS logic levels. Due to the high gain and tight threshold of the receiver, care should be taken to prevent noise from appearing as a valid signal.

The receiver's internal fail-safe circuitry is designed to source/sink a small amount of current, providing fail-safe protection (a stable known state of HIGH output voltage) for floating, terminated or shorted receiver inputs.

1. **Open Input Pins.** The DS90C032 is a quad receiver device, and if an application requires only 1, 2 or 3 receivers, the unused channel(s) inputs should be left OPEN. Do not tie unused receiver inputs to ground or any other voltages. The input is biased by internal high value pull up and pull down resistors to set the output to a HIGH state. This internal circuitry will guarantee a HIGH, stable output state for open inputs.
2. **Terminated Input.** If the driver is disconnected (cable unplugged), or if the driver is in a TRI-STATE or power-off condition, the receiver output will again be in a HIGH state, even with the end of cable 100Ω termination

resistor across the input pins. The unplugged cable can become a floating antenna which can pick up noise. If the cable picks up more than 10mV of differential noise, the receiver may see the noise as a valid signal and switch. To insure that any noise is seen as common-mode and not differential, a balanced interconnect should be used. Twisted pair cable will offer better balance than flat ribbon cable.

3. **Shorted Inputs.** If a fault condition occurs that shorts the receiver inputs together, thus resulting in a 0V differential input voltage, the receiver output will remain in a HIGH state. Shorted input fail-safe is not supported across the common-mode range of the device (GND to 2.4V). It is only supported with inputs shorted and no external common-mode voltage applied.

The footprint of the DS90C032 is the same as the industry standard 26LS32 Quad Differential (RS-422) Receiver.

Pin Descriptions

Pin No. (SOIC)	Name	Description
2, 6, 10, 14	R _{IN+}	Non-inverting receiver input pin
1, 7, 9, 15	R _{IN-}	Inverting receiver input pin
3, 5, 11, 13	R _{OUT}	Receiver output pin
4	EN	Active high enable pin, OR-ed with EN*
12	EN*	Active low enable pin, OR-ed with EN
16	V _{CC}	Power supply pin, +5V ± 10%

Pin No. (SOIC)	Name	Description
8	GND	Ground pin

Ordering Information

Operating Temperature	Package Type/ Number	Order Number
-40°C to +85°C	SOP/M16A	DS90C032TM
-55°C to +125°C	LCC/E20A	DS90C032E-QML
DS90C032E-QML (NSID)		
5962-95834 (SMD)		

Note 1: "Absolute Maximum Ratings" are those values beyond which the safety of the device cannot be guaranteed. They are not meant to imply that the devices should be operated at these limits. The table of "Electrical Characteristics" specifies conditions of device operation.

Note 2: Current into device pins is defined as positive. Current out of device pins is defined as negative. All voltages are referenced to ground unless otherwise specified.

Note 3: All typicals are given for: V_{CC} = +5.0V, T_A = +25°C.

Note 4: Generator waveform for all tests unless otherwise specified: f = 1 MHz, Z_O = 50Ω, t_r and t_f (0%–100%) ≤ 1 ns for R_{IN} and t_r and t_f ≤ 6 ns for EN or EN*.

Note 5: Channel-to-Channel Skew is defined as the difference between the propagation delay of one channel and that of the others on the same chip with an event on the inputs.

Note 6: Chip to Chip Skew is defined as the difference between the minimum and maximum specified differential propagation delays.

Note 7: ESD Rating:

HBM (1.5 kΩ, 100 pF) ≥ 3,500V

EIAJ (0Ω, 200 pF) ≥ 250V

Note 8: Output short circuit current (I_{OS}) is specified as magnitude only, minus sign indicates direction only. Only one output should be shorted at a time, do not exceed maximum junction temperature specification.

Note 9: C_L includes probe and jig capacitance.

Note 10: For DS90C032E propagation delay measurements are from 0V on the input waveform to the 50% point on the output (R_{OUT}).

Typical Performance Characteristics

Output High Voltage vs Power Supply Voltage

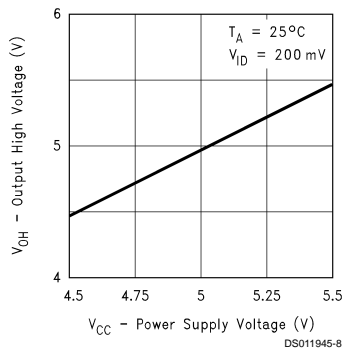

Output High Voltage vs Ambient Temperature

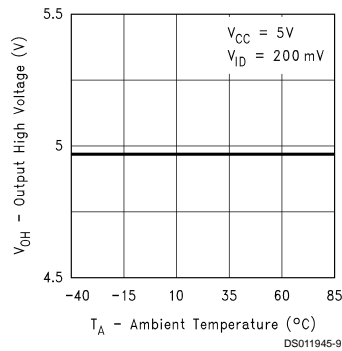

Typical Performance Characteristics (Continued)

Output Low Voltage vs Power Supply Voltage

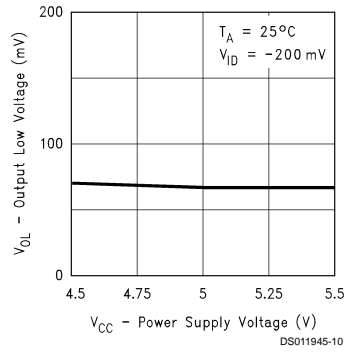

Output Low Voltage vs Ambient Temperature

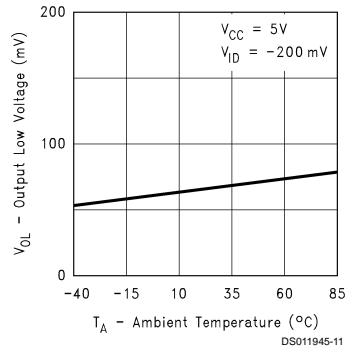

Output Short Circuit Current vs Power Supply Voltage

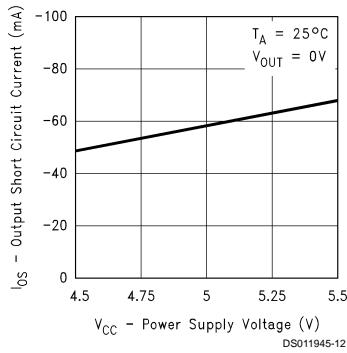

Output Short Circuit Current vs Ambient Temperature

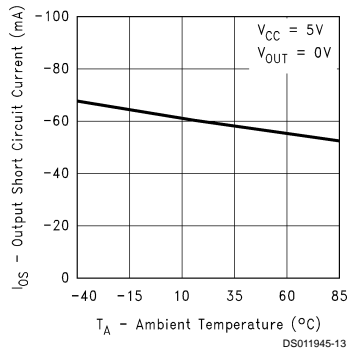

Differential Propagation Delay vs Power Supply Voltage

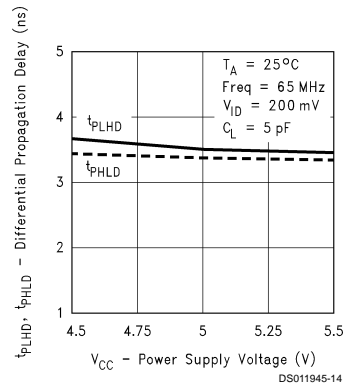

Differential Propagation Delay vs Ambient Temperature

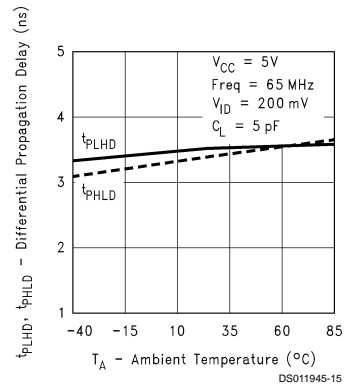

Typical Performance Characteristics (Continued)

Differential Skew vs Power Supply Voltage

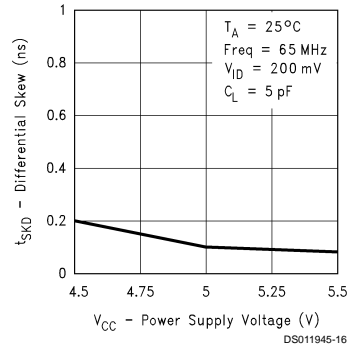

Differential Skew vs Ambient Temperature

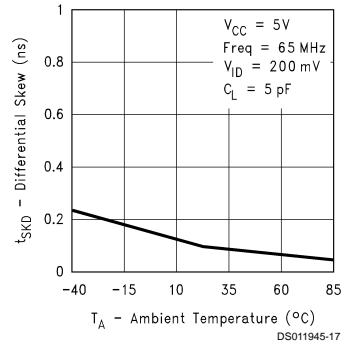

Transition Time vs Power Supply Voltage

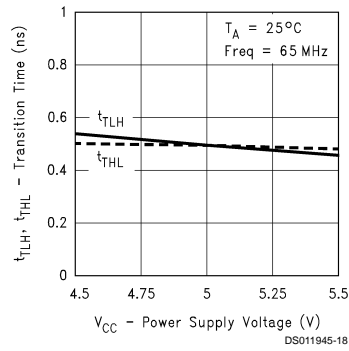

Transition Time vs Ambient Temperature

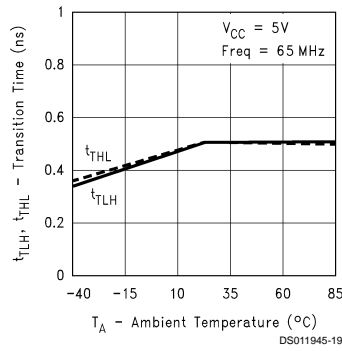

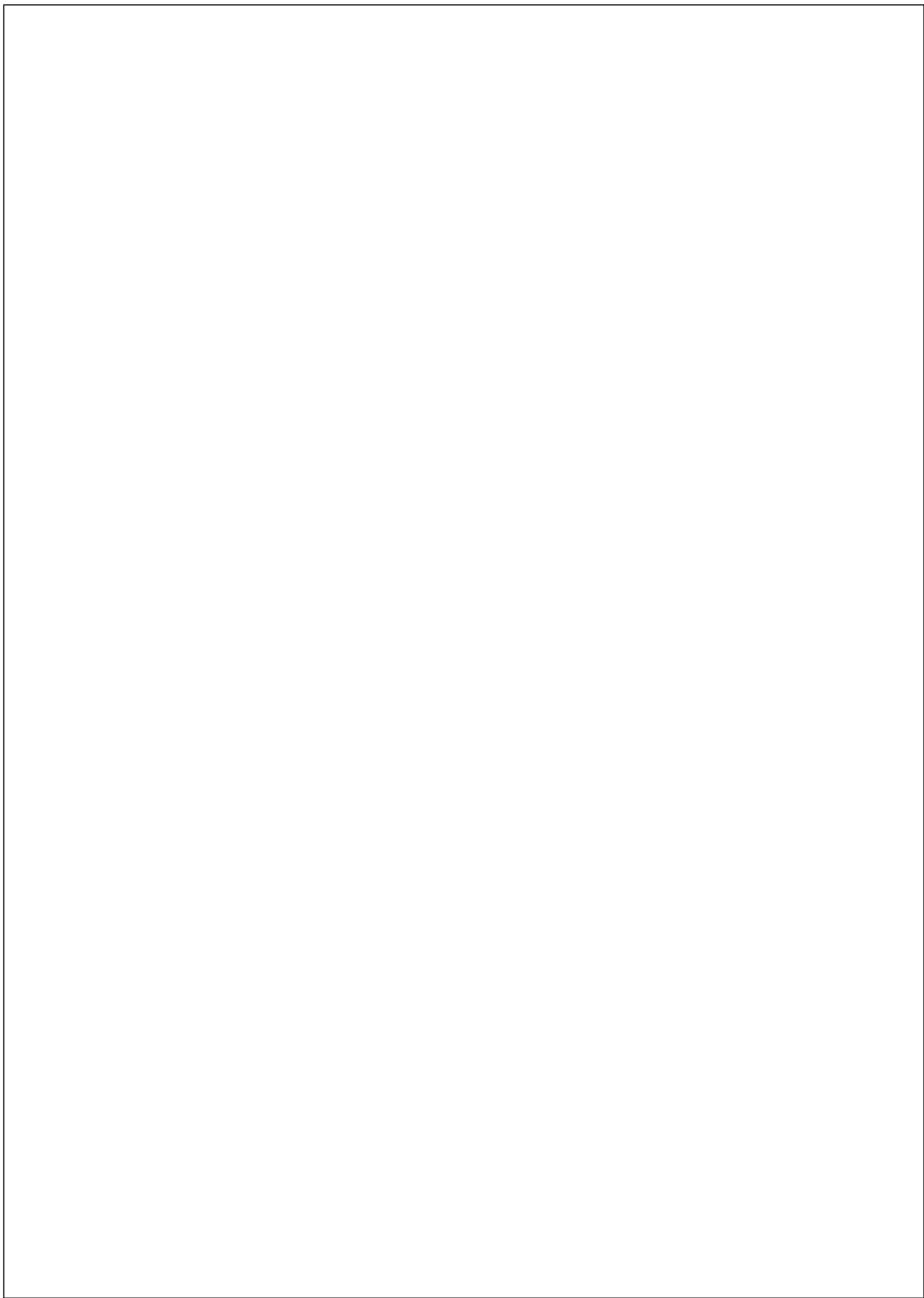

Physical Dimensions inches (millimeters) unless otherwise noted

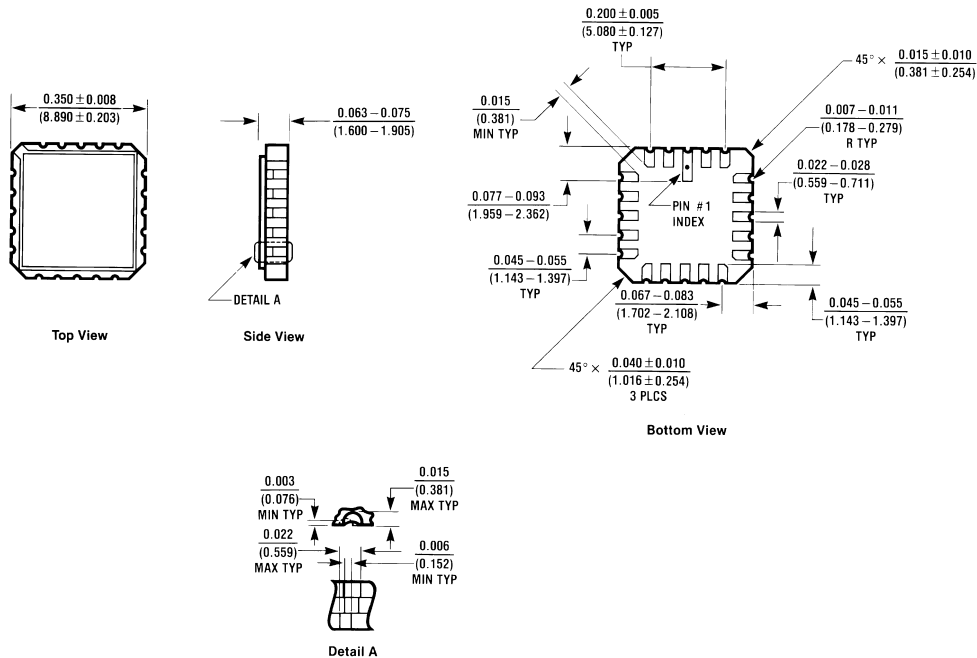

E20A (REV. D)

20-Lead Ceramic Leadless Chip Carrier, Type C
Order Number DS90C032E-QML
NS Package Number E20A

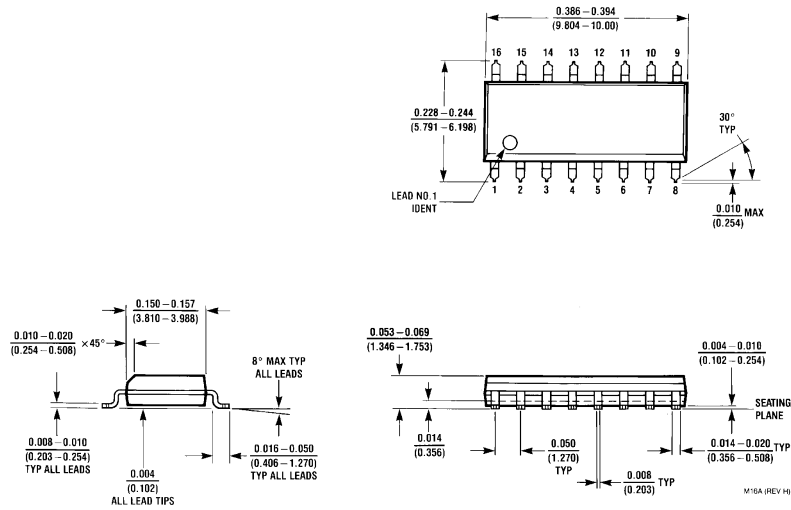

16-Lead (0.150" Wide) Molded Small Outline Package, JEDEC
Order Number DS90C032TM
NS Package Number M16A

LIFE SUPPORT POLICY

NATIONAL'S PRODUCTS ARE NOT AUTHORIZED FOR USE AS CRITICAL COMPONENTS IN LIFE SUPPORT DEVICES OR SYSTEMS WITHOUT THE EXPRESS WRITTEN APPROVAL OF THE PRESIDENT OF NATIONAL SEMICONDUCTOR CORPORATION. As used herein:

1. Life support devices or systems are devices or systems which, (a) are intended for surgical implant into the body, or (b) support or sustain life, and whose failure to perform when properly used in accordance with instructions for use provided in the labeling, can be reasonably expected to result in a significant injury to the user.
2. A critical component in any component of a life support device or system whose failure to perform can be reasonably expected to cause the failure of the life support device or system, or to affect its safety or effectiveness.



National Semiconductor Corporation
Americas
Tel: 1-800-272-9959
Fax: 1-800-737-7018
Email: support@nsc.com

www.national.com

National Semiconductor Europe
Fax: +49 (0) 1 80-530 85 86
Email: europe.support@nsc.com
Deutsch Tel: +49 (0) 1 80-530 85 85
English Tel: +49 (0) 1 80-532 78 32
Français Tel: +49 (0) 1 80-532 93 58
Italiano Tel: +49 (0) 1 80-534 16 80

National Semiconductor Asia Pacific Customer Response Group
Tel: 65-2544466
Fax: 65-2504466
Email: sea.support@nsc.com

National Semiconductor Japan Ltd.
Tel: 81-3-5620-6175
Fax: 81-3-5620-6179