

LM2653

1.5A High Efficiency Synchronous Switching Regulator

General Description

The LM2653 switching regulator provides high efficient power conversion over a 100:1 load range (1.5A to 15 mA). This feature makes the LM2653 an ideal fit in battery-powered applications.

Synchronous rectification is used to achieve up to 97% efficiency. At light loads, the LM2653 enters a low power hysteretic or "sleep" mode to keep the efficiency high. In many applications, the efficiency still exceeds 80% at 15 mA load. A shutdown pin is available to disable the LM2653 and reduce the supply current to 7 μ A.

All the power, control, and drive functions are integrated within the ICs. The ICs contain patented current sensing circuitry for current mode control. This feature eliminates the external current sensing resistor required by other current-mode DC-DC converters.

The ICs have a 300 kHz fixed frequency internal oscillator. The high oscillator frequency allows the use of extremely small, low profile components.

Protection features include thermal shutdown, input undervoltage lockout, adjustable soft-start, cycle by cycle current limit, output overvoltage and undervoltage protections.

Features

- Efficiency up to 97%

- 4V to 14V input voltage range
- 1.5V to 5.0V adjustable output voltage
- 0.1 Ω Switch On Resistance
- 300 kHz fixed frequency internal oscillator
- 7 μ A shutdown current
- Patented current sensing for current mode control
- Input undervoltage lockout
- Output overvoltage shutdown protection
- Output undervoltage shutdown protection
- Adjustable soft-start
- Adjustable PGOOD delay
- Current limit and thermal shutdown

Applications

- Webpad
- Personal digital assistants (PDAs)
- Computer peripherals
- Battery-powered devices
- Notebook computer video supply
- Handheld scanners
- GXM I/O and core voltage
- High efficiency 5V conversion

Typical Application

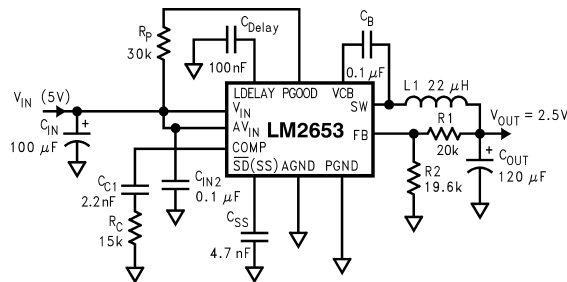
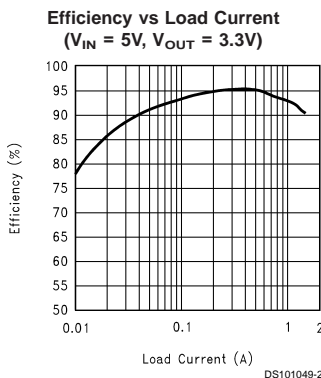

Absolute Maximum Ratings (Note 1)

If Military/Aerospace specified devices are required, please contact the National Semiconductor Sales Office/Distributors for availability and specifications.

Input Voltage	15V
PGOOD Pin Voltage	15V
Feedback Pin Voltage	$-0.4V \leq V_{FB} \leq 5V$
Power Dissipation ($T_A = 25^\circ\text{C}$), (Note 2)	893 mW
Junction Temperature Range	$-40^\circ\text{C} \leq T_J \leq +125^\circ\text{C}$
Storage Temperature Range	-65°C to $+150^\circ\text{C}$

Lead Temperature

M Package

Vapor Phase (60 sec.)

Infrared (15 sec.)

Maximum Junction Temperature

ESD Susceptibility

Human Body Model (Note 3)

215°C

220°C

150°C

1 kV

Operating Ratings (Note 1)

Supply Voltage

 $4V \leq V_{IN} \leq 14V$ **Electrical Characteristics**

Specifications with standard typeface are for $T_J = 25^\circ\text{C}$, and those in **boldface type** apply over full **Operating Temperature Range**. $V_{IN} = 10V$ unless otherwise specified.

Symbol	Parameter	Conditions	Typical (Note 5)	Limit (Note 4)	Units
V_{FB}	Feedback Voltage	$I_{LOAD} = 900\text{ mA}$	1.238	1.200 1.263	V V(min) V(max)
V_{OUT}	Output Voltage Line Regulation	$V_{IN} = 4V$ to $12V$ $I_{LOAD} = 900\text{ mA}$	0.2		%
	Output Voltage Load Regulation	$I_{LOAD} = 10\text{ mA}$ to $1.5A$ $V_{IN} = 5V$	1.3		%
	Output Voltage Load Regulation	$I_{LOAD} = 200\text{ mA}$ to $1.5A$ $V_{IN} = 5V$	0.3		%
V_{INUV}	V_{IN} Undervoltage Lockout Threshold Voltage	Rising Edge	3.8	3.95	V V(max)
V_{UV_HYST}	Hysteresis for the Input Undervoltage Lockout		210		mV
I_{CL}	Switch Current Limit	$V_{IN} = 5V$ $V_{OUT} = 2.5V$	2.0	1.55 2.60	A A(min) A(max)
I_{SM}	Sleep Mode Threshold Current	$V_{IN} = 5V$, $V_{OUT} = 2.5V$	100		mA
V_{HYST}	Sleep Mode Feedback Voltage Hysteresis		24		mV
I_Q	Quiescent Current		1.7	2.0	mA mA(max)
I_{QSD}	Quiescent Current in Shutdown Mode	Shutdown Pin Pulled Low	7	12/20	μA $\mu\text{A}(\text{max})$
$R_{DS(ON)}$	High-Side or Low-Side MOSFET ON Resistance	$I_{SWITCH} = 1A$	75	130	$\text{m}\Omega$ $\text{m}\Omega(\text{max})$
$R_{SW(ON)}$	High-Side or Low-Side Switch On Resistance (MOSFET ON Resistance + Bonding Wire Resistance)	$I_{SWITCH} = 1A$	110		$\text{m}\Omega$
I_L	Switch Leakage Current—High Side		130		nA
	Switch Leakage Current—Low Side		130		nA
V_{BOOT}	Bootstrap Regulator Voltage	$I_{BOOT} = 1\text{ mA}$	6.75	6.45/6.40 6.95/7.00	V V(min) V(max)

Electrical Characteristics (Continued)

Specifications with standard typeface are for $T_J = 25^\circ\text{C}$, and those in **boldface type** apply over full **Operating Temperature Range**. $V_{IN} = 10\text{V}$ unless otherwise specified.

Symbol	Parameter	Conditions	Typical (Note 5)	Limit (Note 4)	Units
G_M	Error Amplifier Transconductance		1250		μmho
A_V	Error Amplifier Voltage Gain		100		
I_{EA_SOURCE}	Error Amplifier Source Current	$V_{IN} = 3.6\text{V}$, $V_{FB} = 1.17\text{V}$, $V_{COMP} = 2\text{V}$	40	25/15	μA $\mu\text{A}(\text{min})$
I_{EA_SINK}	Error Amplifier Sink Current	$V_{IN} = 3.6\text{V}$, $V_{FB} = 1.31\text{V}$, $V_{COMP} = 2\text{V}$	65	30	μA $\mu\text{A}(\text{min})$
V_{EAH}	Error Amplifier Output Swing Upper Limit	$V_{IN} = 4\text{V}$, $V_{FB} = 1.17\text{V}$	2.70	2.50/2.40	V V(min)
V_{EAL}	Error Amplifier Output Swing Lower Limit	$V_{IN} = 4\text{V}$, $V_{FB} = 1.31\text{V}$	1.25	1.35/1.50	V V(max)
V_D	Body Diode Voltage	$I_{DIODE} = 1.5\text{A}$	1		V
F_{OSC}	Oscillator Frequency	Measured at Switch Pin $V_{IN} = 4\text{V}$	300	280/255 330/345	kHz kHz(min) kHz(max)
D_{MAX}	Maximum Duty Cycle	$V_{IN} = 4\text{V}$	95	92	% %(min)
I_{SS}	Soft-Start Current	Voltage at the SS Pin = 1.4V	11	7 14	μA $\mu\text{A}(\text{min})$ $\mu\text{A}(\text{max})$
V_{OUTUV}	V_{OUT} Undervoltage Lockout Threshold Voltage		81	76 84	% V_{OUT} % $V_{OUT}(\text{min})$ % $V_{OUT}(\text{max})$
	Hysteresis for V_{OUTUV}		5		% V_{OUT}
V_{OUTOV}	V_{OUT} Overvoltage Lockout Threshold Voltage		108	106 114	% V_{OUT} % $V_{OUT}(\text{min})$ % $V_{OUT}(\text{max})$
	Hysteresis for V_{OUTOV}		3		% V_{OUT}
I_{LDELAY_SOURCE}	LDELAY Pin Source Current		5		μA
I_{PGOOD_SINK}	PGOOD Pin Sink Current	$V_{PGOOD} = 0.4\text{V}$		15	$\text{mA}(\text{max})$
$I_{PGOOD_LEAKAGE}$	PGOOD Pin Leakage Current	$V_{PGOOD} = 5\text{V}$	50		nA
$I_{SHUTDOWN}$	Shutdown Pin Current	Shutdown Pin Pulled Low	2.2	0.8/0.5 3.7/4.0	μA $\mu\text{A}(\text{min})$ $\mu\text{A}(\text{max})$
$V_{SHUTDOWN}$	Shutdown Pin Threshold Voltage	Rising Edge	0.6	0.3 0.9	V V(min) V(max)
T_{SD}	Thermal Shutdown Temperature		165		$^\circ\text{C}$
T_{SD_HYST}	Thermal Shutdown Hysteresis Temperature		25		$^\circ\text{C}$

Note 1: Absolute Maximum Ratings indicate limits beyond which damage to the device may occur. Operating Ratings indicate conditions for which the device is intended to be functional, but device parameter specifications may not be guaranteed under these conditions. For guaranteed specifications and test conditions, see the Electrical Characteristics.

Note 2: The maximum allowable power dissipation is calculated by using $P_{DMAX} = (T_{JMAX} - T_A)/\theta_{JA}$, where T_{JMAX} is the maximum junction temperature, T_A is the ambient temperature, and θ_{JA} is the junction-to-ambient thermal resistance of the specified package. The 893 mW rating results from using 150°C , 25°C , and 140°C/W for T_{JMAX} , T_A , and θ_{JA} respectively. A θ_{JA} of 140°C/W represents the worst-case condition of no heat sinking of the 16-pin TSSOP package. Heat sinking allows the safe dissipation of more power. The Absolute Maximum power dissipation must be derated by $7.14\text{ mW per }^\circ\text{C}$ above 25°C ambient. The LM2653 actively limits its junction temperatures to about 165°C .

Note 3: The human body model is a 100 pF capacitor discharged through a $1.5\text{ k}\Omega$ resistor into each pin.

Electrical Characteristics (Continued)

Note 4: Typical numbers are at 25°C and represent the most likely norm.

Note 5: All limits guaranteed at room temperature (standard typeface) and at **temperature extremes (bold typeface)**. All room temperature limits are 100% production tested. All limits at **temperature extremes** are guaranteed via correlation using standard Statistical Quality Control (SQC) methods. All limits are used to calculate Average Outgoing Quality Level (AOQL).

Typical Performance Characteristics

Efficiency vs Load Current
($V_{IN} = 5V$, $V_{OUT} = 2.5V$)

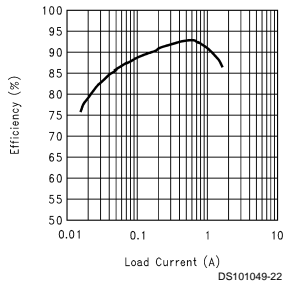

I_Q vs V_{IN}

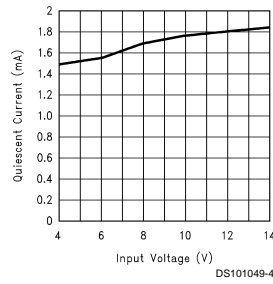

I_{QSD} vs Input Voltage

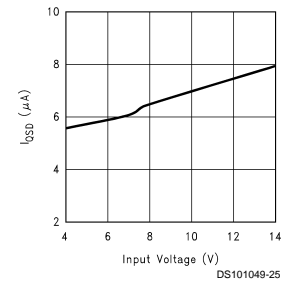

I_{QSD} vs Junction Temperature

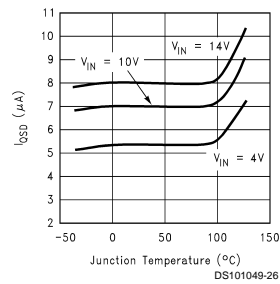

Frequency vs Junction Temperature

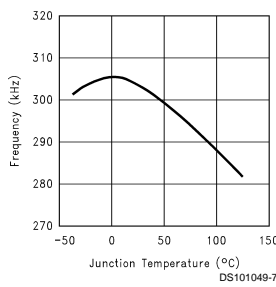

$R_{SW(ON)}$ vs Input Voltage

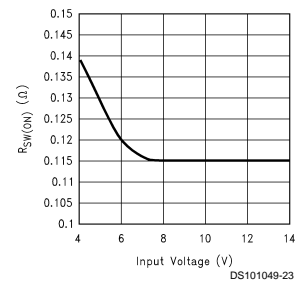

$R_{SW(ON)}$ vs Junction Temperature

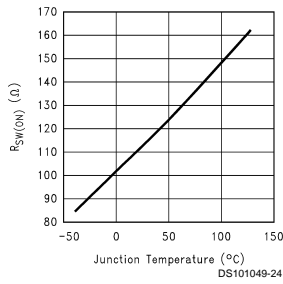

Current Limit vs Input Voltage
($V_{OUT} = 2.5V$)

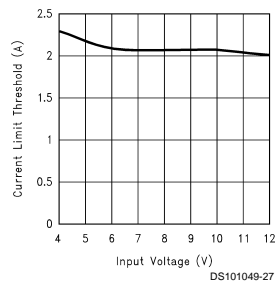

Current Limit vs Junction Temperature
($V_{OUT} = 2.5V$)

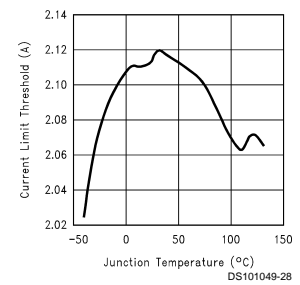

Typical Performance Characteristics (Continued)

Reference Voltage vs Junction Temperature

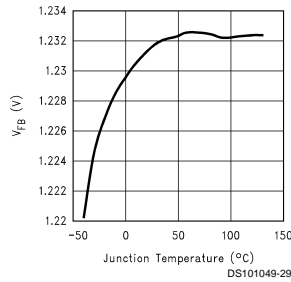

Sleep Mode Threshold vs Output Voltage ($V_{IN} = 5V$)

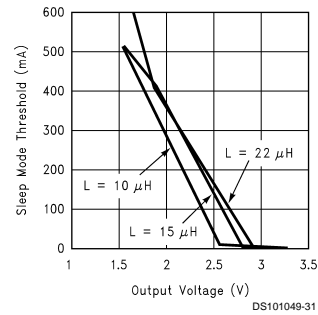

Connection Diagram

16-Lead TSSOP (MTC)

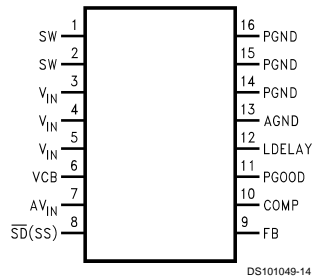

Top View

Order Number LM2653MTC-ADJ
See NS Package Number MTC16

Pin Description

Pin	Name	Function
1-2	SW	Switched-node connection, which is connected with the source of the internal high-side MOSFET.
3-5	V_{IN}	Main power supply input pin. Connected to the drain of the high-side MOSFET.
6	V_{CB}	Bootstrap capacitor connection for high-side gate drive.
7	AV_{IN}	Input voltage for control and driver circuits.
8	$\overline{SD}(SS)$	Shutdown control input, active low. This pin can also function as soft-start control pin. Connect a capacitor from this pin to ground.
9	FB	Output voltage feedback input. Connected to the output voltage.
10	COMP	Compensation network connection. Connected to the output of the voltage error amplifier.
11	PGOOD	A constant monitor on the output voltage. PGOOD will go low if the output voltage exceeds 110% or goes below 80% of its nominal.
12	LDELAY	A capacitor between this pin to ground sets the delay from the output voltage reaches 80% of its nominal to when the undervoltage latch protection is enabled and PGOOD pin goes low.
13	AGND	Low-noise analog ground.
14-16	PGND	Power ground.

Block Diagram

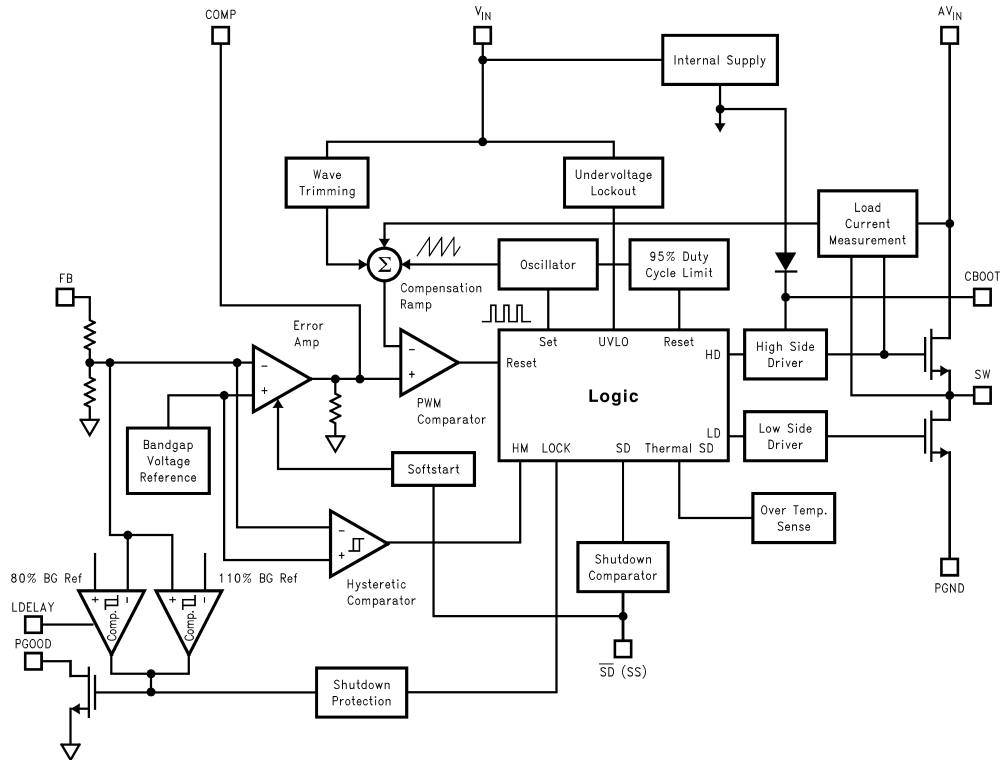

DS101049-15

Operation

The LM2653 operates in a constant frequency (300 kHz), current-mode PWM for moderate to heavy loads; and it automatically switches to hysteretic mode for light loads. In hysteretic mode, the switching frequency is reduced to keep the efficiency high.

Main Operation

When the load current is higher than the sleep mode threshold, the part is always operating in PWM mode. At the beginning of each switching cycle, the high-side switch is turned on, the current from the high-side switch is sensed and compared with the output of the error amplifier (COMP pin). When the sensed current reaches the COMP pin voltage level, the high-side switch is turned off; after 40 ns (dead-time), the low-side switch is turned on. At the end of the switching cycle, the low-side switch is turned off; and the same cycle repeats.

The current of the top switch is sensed by a patented internal circuitry. This unique technique gets rid of the external sense resistor, saves cost and size, and improves noise immunity of the sensed current. A feedforward from the input voltage is added to reduce the variation of the current limit over the input voltage range.

When the load current decreases below the sleep mode threshold, the output voltage will rise slightly, this rise is sensed by the hysteretic mode comparator which makes the part go into the hysteretic mode with both the high and low

side switches off. The output voltage starts to drop until it hits the low threshold of the hysteretic comparator, and the part immediately goes back to the PWM operation. The output voltage keeps increasing until it reaches the top hysteretic threshold, then both the high and low side switches turn off again, and the same cycle repeats.

Protections

The cycle-by-cycle current limit circuitry turns off the high-side MOSFET whenever the current in MOSFET reaches 2A. A second level current limit is accomplished by the undervoltage protection: if the load pulls the output voltage down below 80% of its nominal value, the undervoltage latch protection will wait for a period of time (set by the capacitor at the LDELAY pin, see LDELAY CAPACITOR section for more information). If the output voltage is still below 80% of its nominal after the waiting period, the latch protection will be enabled. In the latch protection mode, the low-side MOSFET is on and the high-side MOSFET is off. The latch protection will also be enabled immediately whenever the output voltage exceeds the overvoltage threshold (110% of its nominal). Both protections are disabled during start-up. (See SOFT-START CAPACITOR section and LDELAY CAPACITOR section for more information.) Toggling the input supply voltage or the shutdown pin can reset the device from the latched protection mode.

Operation (Continued)

PGOOD Flag

The PGOOD flag goes low whenever the overvoltage or undervoltage latch protection is enabled.

DESIGN PROCEDURE

This section presents guidelines for selecting external components.

INPUT CAPACITOR

A low ESR aluminum, tantalum, or ceramic capacitor is needed between the input pin and power ground. This capacitor prevents large voltage transients from appearing at the input. The capacitor is selected based on the RMS current and voltage requirements. The RMS current is given by:

$$I_{\text{RMS}} = I_{\text{OUT}} \times \frac{\sqrt{V_{\text{OUT}}(V_{\text{IN}} - V_{\text{OUT}})}}{V_{\text{IN}}}$$

The RMS current reaches its maximum ($I_{\text{OUT}}/2$) when V_{IN} equals $2V_{\text{OUT}}$. For an aluminum or ceramic capacitor, the voltage rating should be at least 25% higher than the maximum input voltage. If a tantalum capacitor is used, the voltage rating required is about twice the maximum input voltage. The tantalum capacitor should be surge current tested by the manufacturer to prevent shorted by the inrush current. It is also recommended to put a small ceramic capacitor (0.1 μF) between the input pin and ground pin to reduce high frequency spikes.

INDUCTOR

The most critical parameters for the inductor are the inductance, peak current and the DC resistance. The inductance is related to the peak-to-peak inductor ripple current, the input and the output voltage:

$$L = \frac{(V_{\text{IN}} - V_{\text{OUT}})V_{\text{OUT}}}{V_{\text{IN}} \times I_{\text{RIPPLE}} \times 300 \text{ kHz}}$$

A higher value of ripple current reduces inductance, but increases the conduction loss, core loss, current stress for the inductor and switch devices. It also requires a bigger output capacitor for the same output voltage ripple requirement. A reasonable value is setting the ripple current to be 30% of the DC output current. Since the ripple current increases with the input voltage, the maximum input voltage is always used to determine the inductance. The DC resistance of the inductor is a key parameter for the efficiency. Lower DC resistance is available with a bigger winding area. A good tradeoff between the efficiency and the core size is letting the inductor copper loss equal 2% of the output power.

OUTPUT CAPACITOR

The selection of C_{OUT} is driven by the maximum allowable output voltage ripple. The output ripple in the constant frequency, PWM mode is approximated by:

$$V_{\text{RIPPLE}} = I_{\text{RIPPLE}} \left(\text{ESR} + \frac{1}{8F_S C_{\text{OUT}}} \right)$$

The ESR term usually plays the dominant role in determining the voltage ripple. A low ESR aluminum electrolytic or tantalum capacitor (such as Nichicon PL series, Sanyo OS-CON, Sprague 593D, 594D, AVX TPS, and CDE polymer aluminum) is recommended. An electrolytic capacitor is not recommended for temperatures below -25°C since its ESR

rises dramatically at cold temperature. A tantalum capacitor has a much better ESR specification at cold temperature and is preferred for low temperature applications.

The output voltage ripple in constant frequency mode has to be less than the sleep mode voltage hysteresis to avoid entering the sleep mode at full load:

$$V_{\text{RIPPLE}} < 20\text{mV} * V_{\text{OUT}} / V_{\text{FB}}$$

BOOST CAPACITOR

A 0.1 μF ceramic capacitor is recommended for the boost capacitor. The typical voltage across the boost capacitor is 6.7V.

SOFT-START CAPACITOR

A soft-start capacitor is used to provide the soft-start feature. When the input voltage is first applied, or when the $\overline{\text{SD}}(\text{SS})$ pin is allowed to go high, the soft-start capacitor is charged by a current source (approximately 2 μA). When the $\overline{\text{SD}}(\text{SS})$ pin voltage reaches 0.6V (shutdown threshold), the internal regulator circuitry starts to operate. The current charging the soft-start capacitor increases from 2 μA to approximately 10 μA . With the $\overline{\text{SD}}(\text{SS})$ pin voltage between 0.6V and 1.3V, the level of the current limit is zero, which means the output voltage is still zero. When the $\overline{\text{SD}}(\text{SS})$ pin voltage increases beyond 1.3V, the current limit starts to increase. The switch duty cycle, which is controlled by the level of the current limit, starts with narrow pulses and gradually gets wider. At the same time, the output voltage of the converter increases towards the nominal value, which brings down the output voltage of the error amplifier. When the output of the error amplifier is less than the current limit voltage, it takes over the control of the duty cycle. The converter enters the normal current-mode PWM operation. The $\overline{\text{SD}}(\text{SS})$ pin voltage is eventually charged up to about 2V.

The soft-start time can be estimated as:

$$T_{\text{SS}} = C_{\text{SS}} * 0.6\text{V}/2 \mu\text{A} + C_{\text{SS}} * (2\text{V}-0.6\text{V})/10 \mu\text{A}$$

During start-up, the internal circuit is monitoring the soft-start voltage. When the softstart voltage reaches 2V, the undervoltage and overvoltage protections are enabled.

If the output voltage doesn't rise above 80% of the normal value before the soft-start reaches 2V. The undervoltage protection will kick in and shut the device down. You can avoid this by either increasing the value of the soft-start capacitor, or using a LDELAY capacitor.

LDELAY CAPACITOR

As mentioned in the operation section, the LDELAY capacitor sets the time delay between the output voltage goes below 80% of its nominal value and the undervoltage latch protection is enabled.

Charging the CDELAY by a 5 μA current source up to 2V sets the delay time. Therefore, $T_{\text{DELAY}} = C_{\text{DELAY}} * 2\text{V}/5\mu\text{A}$.

The undervoltage protection is disabled by tying the LDELAY pin to the ground.

R₁ and R₂ (Programming Output Voltage)

Use the following formula to select the appropriate resistor values:

$$V_{\text{OUT}} = V_{\text{REF}}(1 + R_1/R_2)$$

where $V_{\text{REF}} = 1.238\text{V}$

Select resistors between 10k Ω and 100k Ω . (1% or higher accuracy metal film resistors for R₁ and R₂.)

DESIGN PROCEDURE (Continued)

COMPENSATION COMPONENTS

In the control to output transfer function, the first pole F_{p1} can be estimated as $1/(2\pi R_{OUT} C_{OUT})$; The ESR zero F_{z1} of the output capacitor is $1/(2\pi ESR C_{OUT})$; Also, there is a high frequency pole F_{p2} in the range of 45kHz to 150kHz:

$$F_{p2} = F_s/(\pi n(1-D))$$

where $D = V_{OUT}/V_{IN}$, $n = 1+0.348L/(V_{IN}-V_{OUT})$ (L is in μ Hz and V_{IN} and V_{OUT} in volts).

The total loop gain G is approximately $500/I_{OUT}$ where I_{OUT} is in amperes.

A Gm amplifier is used inside the LM2653. The output resistor R_o of the Gm amplifier is about $80k\Omega$. C_{c1} and R_c together with R_o give a lag compensation to roll off the gain:

$$F_{pc1} = 1/(2\pi C_{c1}(R_o+R_c)), F_{zc1} = 1/2\pi C_{c1}R_c$$

In some applications, the ESR zero F_{z1} can not be cancelled by F_{p2} . Then, C_{c2} is needed to introduce F_{pc2} to cancel the ESR zero, $F_{p2} = 1/(2\pi C_{c2}R_o \parallel R_c)$.

The rule of thumb is to have more than 45° phase margin at the crossover frequency ($G=1$).

If C_{OUT} is higher than 68μ F, $C_{c1} = 2.2n$ F, and $R_c = 15k\Omega$ are good choices for most applications. If the ESR zero is too low to be cancelled by F_{p2} , add C_{c2} .

If the transient response to a step load is important, choose R_c to be higher than $10k\Omega$.

EXTERNAL SCHOTTKY DIODE

A Schottky diode D_1 is recommended to prevent the intrinsic body diode of the low-side MOSFET from conducting during the deadtime in PWM operation and hysteretic mode when both MOSFETs are off. If the body diode turns on, there is extra power dissipation in the body diode because of the reverse-recovery current and higher forward voltage; the

high-side MOSFET also has more switching loss since the negative diode reverse-recovery current appears as the high-side MOSFET turn-on current in addition to the load current. These losses degrade the efficiency by 1-2%. The improved efficiency and noise immunity with the Schottky diode become more obvious with increasing input voltage and load current.

The breakdown voltage rating of D_1 is preferred to be 25% higher than the maximum input voltage. Since D_1 is only on for a short period of time, the average current rating for D_1 only requires being higher than 30% of the maximum output current. It is important to place D_1 very close to the drain and source of the low-side MOSFET, extra parasitic inductance in the parallel loop will slow the turn-on of D_1 and direct the current through the body diode of the low-side MOSFET.

PCB LAYOUT CONSIDERATIONS

Layout is critical to reduce noises and ensure specified performance. The important guidelines are listed as follows:

1. Minimize the parasitic inductance in the loop of input capacitors and the internal MOSFETs by connecting the input capacitors to V_{IN} and PGND pins with short and wide traces. This is important because the rapidly switching current, together with wiring inductance can generate large voltage spikes that may result in noise problems.
2. Minimize the trace from the center of the output resistor divider to the FB pin and keep it away from noise sources to avoid noise pick up. For applications require tight regulation at the output, a dedicated sense trace (separated from the power trace) is recommended to connect the top of the resistor divider to the output.
3. If the Schottky diode D_1 is used, minimize the traces connecting D_1 to SW and PGND pins.

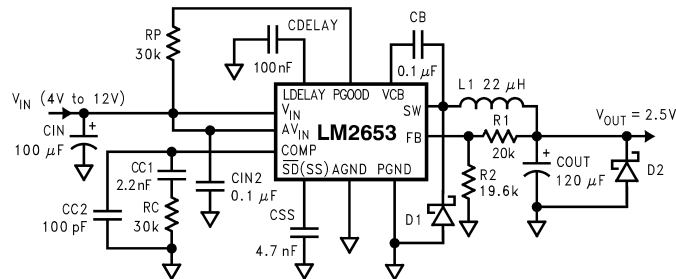

Schematic for the Typical Board Layout

DS101049-1

Typical PC Board Layout: (2X Size)

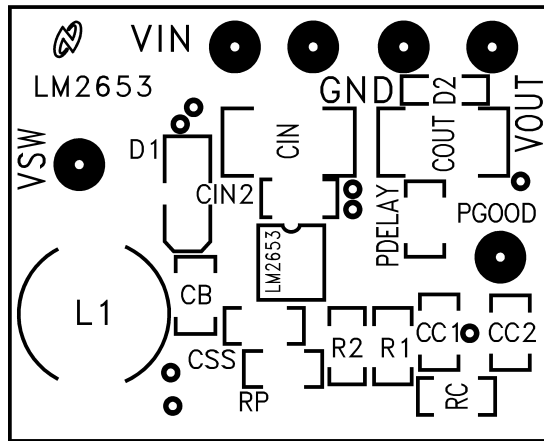

DS101049-19

Component Placement Guide

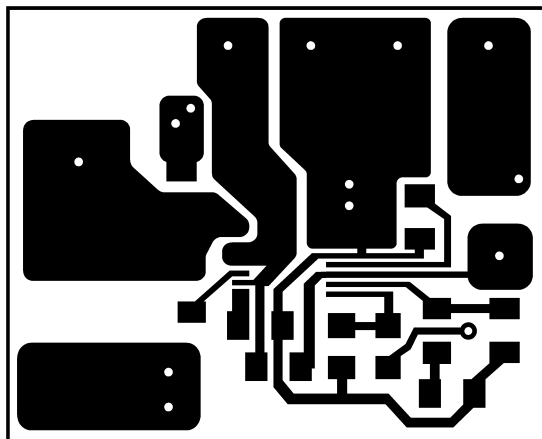

DS101049-20

Component Side PC Board Layout

Typical PC Board Layout: (2X Size) (Continued)

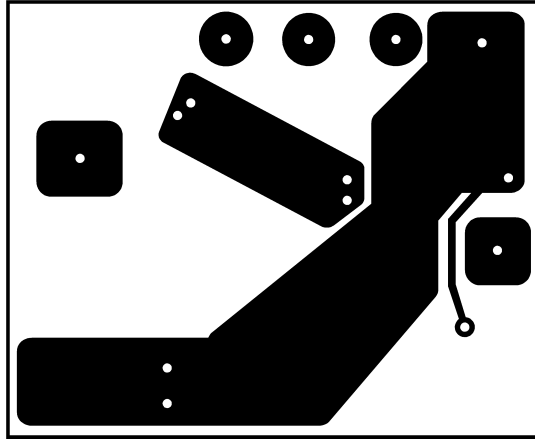

DS101049-21

Solder Side PC Board Layout

Physical Dimensions inches (millimeters) unless otherwise noted

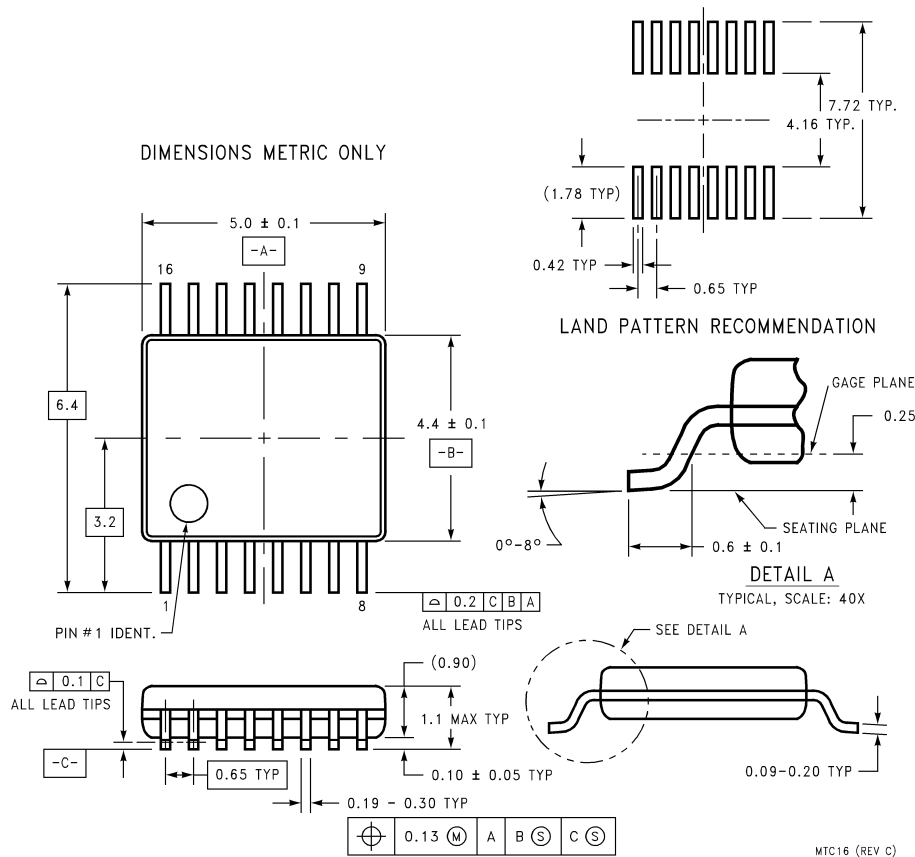

16-Lead TSSOP (MTC)
Order Number LM2653MTC-ADJ
NS Package Number MTC16

MTC16 (REV C)

LIFE SUPPORT POLICY

NATIONAL'S PRODUCTS ARE NOT AUTHORIZED FOR USE AS CRITICAL COMPONENTS IN LIFE SUPPORT DEVICES OR SYSTEMS WITHOUT THE EXPRESS WRITTEN APPROVAL OF THE PRESIDENT AND GENERAL COUNSEL OF NATIONAL SEMICONDUCTOR CORPORATION. As used herein:

1. Life support devices or systems are devices or systems which, (a) are intended for surgical implant into the body, or (b) support or sustain life, and whose failure to perform when properly used in accordance with instructions for use provided in the labeling, can be reasonably expected to result in a significant injury to the user.
2. A critical component is any component of a life support device or system whose failure to perform can be reasonably expected to cause the failure of the life support device or system, or to affect its safety or effectiveness.

National Semiconductor Corporation
 Americas
 Tel: 1-800-272-9959
 Fax: 1-800-737-7018
 Email: support@nsc.com

National Semiconductor Europe
 Fax: +49 (0) 1 80-530 85 86
 Email: europe.support@nsc.com
 Deutsch Tel: +49 (0) 1 80-530 85 85
 English Tel: +49 (0) 1 80-532 78 32
 Français Tel: +49 (0) 1 80-532 93 58
 Italiano Tel: +49 (0) 1 80-534 16 80

National Semiconductor Asia Pacific Customer Response Group
 Tel: 65-2544466
 Fax: 65-2504466
 Email: sea.support@nsc.com

National Semiconductor Japan Ltd.
 Tel: 81-3-5639-7560
 Fax: 81-3-5639-7507

www.national.com