

LM2676

SIMPLE SWITCHER® High Efficiency 3A Step-Down Voltage Regulator

General Description

The LM2676 series of regulators are monolithic integrated circuits which provide all of the active functions for a step-down (buck) switching regulator capable of driving up to 3A loads with excellent line and load regulation characteristics. High efficiency (>90%) is obtained through the use of a low ON-resistance DMOS power switch. The series consists of fixed output voltages of 3.3V, 5V and 12V and an adjustable output version.

The SIMPLE SWITCHER concept provides for a complete design using a minimum number of external components. A high fixed frequency oscillator (260KHz) allows the use of physically smaller sized components. A family of standard inductors for use with the LM2676 are available from several manufacturers to greatly simplify the design process.

The LM2676 series also has built in thermal shutdown, current limiting and an ON/OFF control input that can power down the regulator to a low 50µA quiescent current standby condition. The output voltage is guaranteed to a ±2% tolerance. The clock frequency is controlled to within a ±11% tolerance.

Features

- Efficiency up to 94%
- Simple and easy to design with (using off-the-shelf external components)
- 150 mΩ DMOS output switch
- 3.3V, 5V and 12V fixed output and adjustable (1.2V to 37V) versions
- 50µA standby current when switched OFF
- ±2% maximum output tolerance over full line and load conditions
- Wide input voltage range: 8V to 40V
- 260 KHz fixed frequency internal oscillator
- -40 to +125°C operating junction temperature range

Applications

- Simple to design, high efficiency (>90%) step-down switching regulators
- Efficient system pre-regulator for linear voltage regulators
- Battery chargers

Typical Application

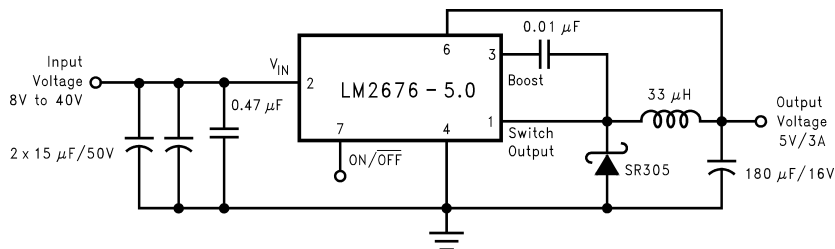

DS100914-3

SIMPLE SWITCHER® is a registered trademark of National Semiconductor Corporation.

Connection Diagram and Ordering Information

**TO-263 Package
Top View**

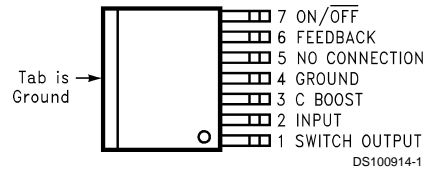

Order Number
LM2676S-3.3, LM2676S-5.0,
LM2676S-12 or LM2676S-ADJ
See NSC Package Number TS7B

**TO-220 Package
Top View**

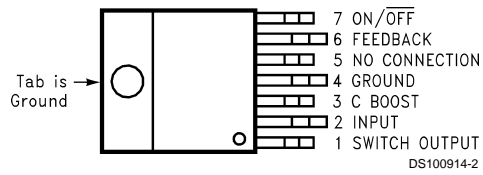

Order Number
LM2676T-3.3, LM2676T-5.0,
LM2676T-12 or LM2676T-ADJ
See NSC Package Number TA07B

Absolute Maximum Ratings (Note 1)

If Military/Aerospace specified devices are required, please contact the National Semiconductor Sales Office/Distributors for availability and specifications.

| | |
|--------------------------|--------------------|
| Input Supply Voltage | 45V |
| ON/OFF Pin Voltage | -0.1V to 6V |
| Switch Voltage to Ground | -1V to V_{IN} |
| Boost Pin Voltage | $V_{SW} + 8V$ |
| Feedback Pin Voltage | -0.3V to 14V |
| Power Dissipation | Internally Limited |
| ESD (Note 2) | 2 kV |

| | |
|---------------------------|----------------|
| Storage Temperature Range | -65°C to 150°C |
| Soldering Temperature | |
| Wave | 4 sec, 260°C |
| Infrared | 10 sec, 240°C |
| Vapor Phase | 75 sec, 219°C |

Operating Ratings

| | |
|--------------------------------------|----------------|
| Supply Voltage | 8V to 40V |
| Junction Temperature Range (T_J) | -40°C to 125°C |

Electrical Characteristics Limits appearing in **bold type face** apply over the entire junction temperature range of operation, -40°C to 125°C. Specifications appearing in normal type apply for $T_A = T_J = 25^\circ\text{C}$.

LM2676-3.3

| Symbol | Parameter | Conditions | Typical (Note 3) | Min (Note 4) | Max (Note 4) | Units |
|-----------|----------------|---|---------------------|---------------------|---------------------|-------|
| V_{OUT} | Output Voltage | $V_{IN} = 8V \text{ to } 40V, 100mA \leq I_{OUT} \leq 3A$ | 3.3 | 3.234/ 3.201 | 3.366/ 3.399 | V |
| η | Efficiency | $V_{IN} = 12V, I_{LOAD} = 3A$ | 86 | | | % |

LM2676-5.0

| Symbol | Parameter | Conditions | Typical (Note 3) | Min (Note 4) | Max (Note 4) | Units |
|-----------|----------------|---|---------------------|---------------------|---------------------|-------|
| V_{OUT} | Output Voltage | $V_{IN} = 8V \text{ to } 40V, 100mA \leq I_{OUT} \leq 3A$ | 5.0 | 4.900/ 4.850 | 5.100/ 5.150 | V |
| η | Efficiency | $V_{IN} = 12V, I_{LOAD} = 3A$ | 88 | | | % |

LM2676-12

| Symbol | Parameter | Conditions | Typical (Note 3) | Min (Note 4) | Max (Note 4) | Units |
|-----------|----------------|--|---------------------|---------------------|---------------------|-------|
| V_{OUT} | Output Voltage | $V_{IN} = 15V \text{ to } 40V, 100mA \leq I_{OUT} \leq 3A$ | 12 | 11.76/ 11.64 | 12.24/ 12.36 | V |
| η | Efficiency | $V_{IN} = 24V, I_{LOAD} = 3A$ | 94 | | | % |

LM2676-ADJ

| Symbol | Parameter | Conditions | Typ (Note 3) | Min (Note 4) | Max (Note 4) | Units |
|----------|------------------|--|-----------------|---------------------|---------------------|-------|
| V_{FB} | Feedback Voltage | $V_{IN} = 8V \text{ to } 40V, 100mA \leq I_{OUT} \leq 3A$ V_{OUT} Programmed for 5V | 1.21 | 1.186/ 1.174 | 1.234/ 1.246 | V |
| η | Efficiency | $V_{IN} = 12V, I_{LOAD} = 3A$ | 88 | | | % |

All Output Voltage Versions Electrical Characteristics

Limits appearing in **bold type face** apply over the entire junction temperature range of operation, -40°C to 125°C . Specifications appearing in normal type apply for $T_A = T_J = 25^{\circ}\text{C}$. Unless otherwise specified $V_{IN}=12\text{V}$ for the 3.3V, 5V and Adjustable versions and $V_{IN}=24\text{V}$ for the 12V version.

| Symbol | Parameter | Conditions | Typ | Min | Max | Units |
|--------------------------|---------------------------|---|---------|---------|-----------|----------------------|
| DEVICE PARAMETERS | | | | | | |
| I_Q | Quiescent Current | $V_{FEEDBACK} = 8\text{V}$ For 3.3V, 5.0V, and ADJ Versions $V_{FEEDBACK} = 15\text{V}$ For 12V Versions | 4.2 | | 6 | mA |
| I_{STBY} | Standby Quiescent Current | ON/OFF Pin = 0V | 50 | | 100/150 | μA |
| I_{CL} | Current Limit | | 4.5 | 3.8/3.6 | 5.25/5.4 | A |
| I_L | Output Leakage Current | $V_{IN} = 40\text{V}$, ON/OFF Pin = 0V $V_{SWITCH} = 0\text{V}$ $V_{SWITCH} = -1\text{V}$ | 1 6 | | 200 15 | μA mA |
| $R_{DS(ON)}$ | Switch On-Resistance | $I_{SWITCH} = 3\text{A}$ | 0.15 | | 0.17/0.29 | Ω |
| f_O | Oscillator Frequency | Measured at Switch Pin | 260 | 225 | 280 | kHz |
| D | Duty Cycle | Maximum Duty Cycle Minimum Duty Cycle | 91 0 | | | % % |
| I_{BIAS} | Feedback Bias Current | $V_{FEEDBACK} = 1.3\text{V}$ ADJ Version Only | 85 | | | nA |
| $V_{ON/OFF}$ | ON/OFF Threshold Voltage | | 1.4 | 0.8 | 2.0 | V |
| $I_{ON/OFF}$ | ON/OFF Input Current | ON/OFF Input = 0V | 20 | | 45 | μA |
| θ_{JA} | Thermal Resistance | T Package, Junction to Ambient (Note 5) | 65 | | | $^{\circ}\text{C/W}$ |
| θ_{JA} | | T Package, Junction to Ambient (Note 6) | 45 | | | |
| θ_{JC} | | T Package, Junction to Case | 2 | | | |
| θ_{JA} | | S Package, Junction to Ambient (Note 7) | 56 | | | |
| θ_{JA} | | S Package, Junction to Ambient (Note 8) | 35 | | | |
| θ_{JA} | | S Package, Junction to Ambient (Note 9) | 26 | | | |
| θ_{JA} | | S Package, Junction to Ambient (Note 9) | 26 | | | |
| θ_{JC} | | S Package, Junction to Case | 2 | | | |

Note 1: Absolute Maximum Ratings are limits beyond which damage to the device may occur. Operating Ratings indicate conditions under which of the device is guaranteed. Operating Ratings do not imply guaranteed performance limits. For guaranteed performance limits and associated test condition, see the electrical Characteristics tables.

Note 2: ESD was applied using the human-body model, a 100pF capacitor discharged through a 1.5 k Ω resistor into each pin.

Note 3: Typical values are determined with $T_A = T_J = 25^{\circ}\text{C}$ and represent the most likely norm.

Note 4: All limits are guaranteed at room temperature (standard type face) and at **temperature extremes (bold type face)**. All room temperature limits are 100% tested during production with $T_A = T_J = 25^{\circ}\text{C}$. All limits at temperature extremes are guaranteed via correlation using standard standard Quality Control (SQC) methods. All limits are used to calculate Average Outgoing Quality Level (AOQL).

Note 5: Junction to ambient thermal resistance (no external heat sink) for the 7 lead TO-220 package mounted vertically, with $\frac{1}{2}$ inch leads in a socket, or on a PC board with minimum copper area.

Note 6: Junction to ambient thermal resistance (no external heat sink) for the 7 lead TO-220 package mounted vertically, with $\frac{1}{2}$ inch leads soldered to a PC board containing approximately 4 square inches of (1 oz.) copper area surrounding the leads.

(Continued)

Note 7: Junction to ambient thermal resistance for the 7 lead TO-263 mounted horizontally against a PC board area of 0.136 square inches (the same size as the TO-263 package) of 1 oz. (0.0014 in. thick) copper.

Note 8: Junction to ambient thermal resistance for the 7 lead TO-263 mounted horizontally against a PC board area of 0.4896 square inches (3.6 times the area of the TO-263 package) of 1 oz. (0.0014 in. thick) copper.

Note 9: Junction to ambient thermal resistance for the 7 lead TO-263 mounted horizontally against a PC board copper area of 1.0064 square inches (7.4 times the area of the TO-263 package) of 1 oz. (0.0014 in. thick) copper. Additional copper area will reduce thermal resistance further. See the thermal model in Switchers Made Simple® software.

Typical Performance Characteristics

Normalized Output Voltage

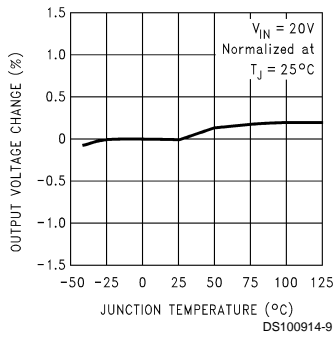

Line Regulation

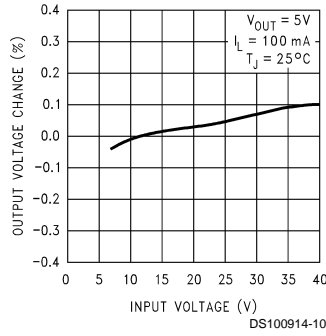

Efficiency vs Input Voltage

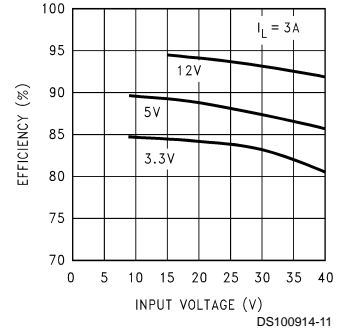

Efficiency vs I_LOAD

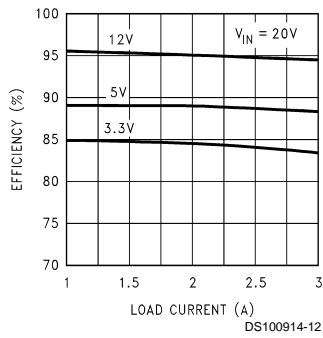

Switch Current Limit

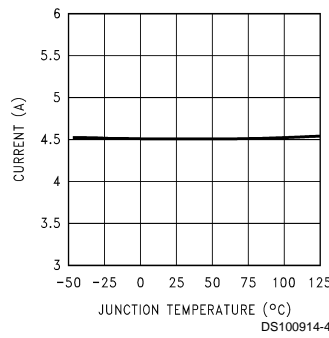

Operating Quiescent Current

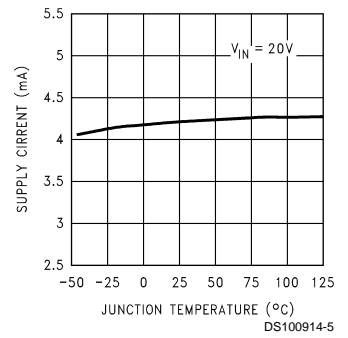

Standby Quiescent Current

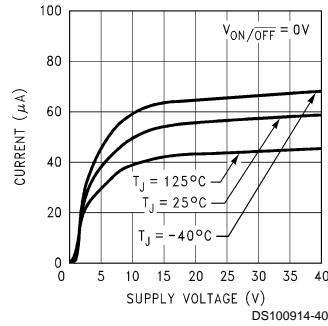

ON/OFF Threshold Voltage

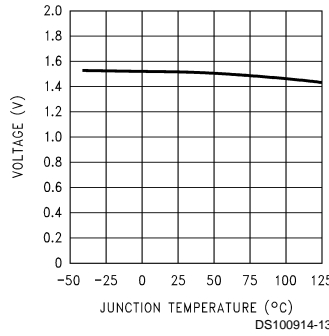

ON/OFF Pin Current (Sourcing)

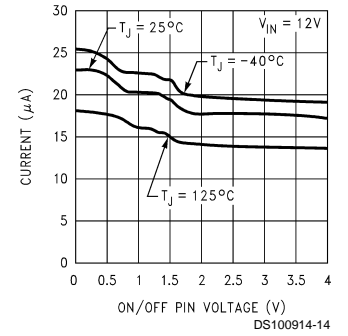

Switching Frequency

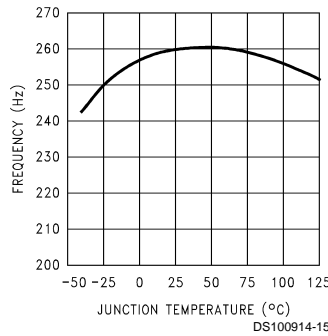

Feedback Pin Bias Current

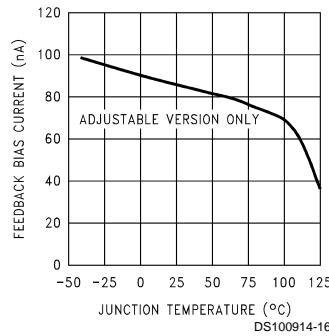

Block Diagram

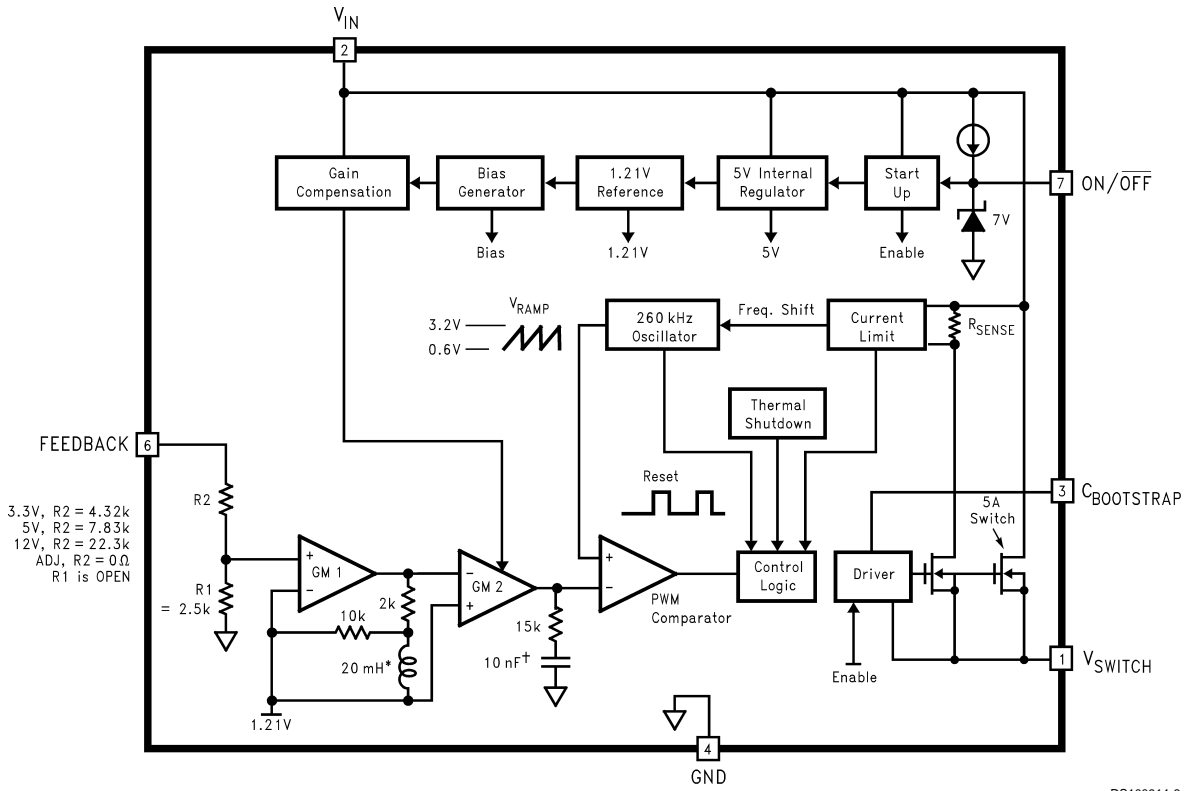

* Active Inductor Patent Number 5,514,947
 † Active Capacitor Patent Number 5,382,918

DS100914-6

Typical Performance Characteristics

Continuous Mode Switching Waveforms

$V_{IN} = 20V, V_{OUT} = 5V, I_{LOAD} = 3A$
 $L = 33 \mu H, C_{OUT} = 200 \mu F, C_{OUTESR} = 26 m\Omega$

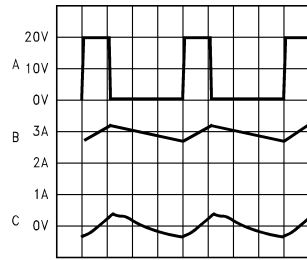

1 $\mu sec/Div$
 DS100914-17

A: V_{SW} Pin Voltage, 10 V/div.
 B: Inductor Current, 1 A/div
 C: Output Ripple Voltage, 20 mV/div AC-Coupled

Horizontal Time Base: 1 $\mu s/div$

Discontinuous Mode Switching Waveforms

$V_{IN} = 20V, V_{OUT} = 5V, I_{LOAD} = 500 mA$
 $L = 10 \mu H, C_{OUT} = 400 \mu F, C_{OUTESR} = 13 m\Omega$

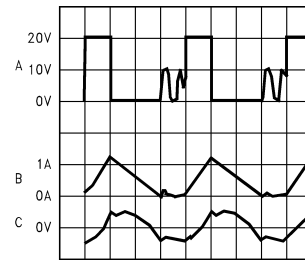

1 $\mu sec/Div$
 DS100914-18

A: V_{SW} Pin Voltage, 10 V/div.
 B: Inductor Current, 1 A/div
 C: Output Ripple Voltage, 20 mV/div AC-Coupled

Horizontal Time Base: 1 $\mu s/div$

Load Transient Response for Continuous Mode

$V_{IN} = 20V, V_{OUT} = 5V$
 $L = 33 \mu H, C_{OUT} = 200 \mu F, C_{OUTESR} = 26 m\Omega$

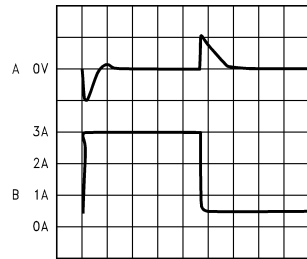

100 $\mu sec/Div$
 DS100914-19

A: Output Voltage, 100 mV/div, AC-Coupled.
 B: Load Current: 500 mA to 3A Load Pulse

Horizontal Time Base: 100 $\mu s/div$

Load Transient Response for Discontinuous Mode

$V_{IN} = 20V, V_{OUT} = 5V,$
 $L = 10 \mu H, C_{OUT} = 400 \mu F, C_{OUTESR} = 13 m\Omega$

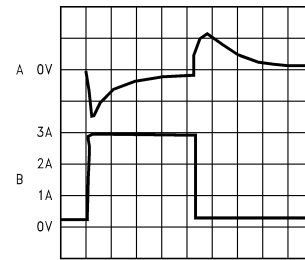

200 $\mu sec/Div$
 DS100914-20

A: Output Voltage, 100 mV/div, AC-Coupled.
 B: Load Current: 200 mA to 3A Load Pulse

Horizontal Time Base: 200 $\mu s/div$

Application Hints

The LM2676 provides all of the active functions required for a step-down (buck) switching regulator. The internal power switch is a DMOS power MOSFET to provide power supply designs with high current capability, up to 3A, and highly efficient operation.

The LM2676 is part of the **SIMPLE SWITCHER** family of power converters. A complete design uses a minimum number of external components, which have been pre-determined from a variety of manufacturers. Using either this data sheet or a design software program called **LM267X Made Simple** (version 2.0) a complete switching power supply can be designed quickly. The software is provided free of charge and can be downloaded from National Semiconductor's Internet site located at <http://www.national.com>.

PIN 1 - Switch Output

This is the output of a power MOSFET switch connected directly to the input voltage. The switch provides energy to an inductor, an output capacitor and the load circuitry under control of an internal pulse-width-modulator (PWM). The PWM controller is internally clocked by a fixed 260KHz oscillator. In a standard step-down application the duty cycle (Time ON/Time OFF) of the power switch is proportional to the ratio of the power supply output voltage to the input voltage. The voltage on pin 1 switches between V_{IN} (switch ON) and below ground by the voltage drop of the external Schottky diode (switch OFF).

PIN 2 - Input

The input voltage for the power supply is connected to pin 2. In addition to providing energy to the load the input voltage also provides bias for the internal circuitry of the LM2676. For guaranteed performance the input voltage must be in the range of 8V to 40V. For best performance of the power supply the input pin should always be bypassed with an input capacitor located close to pin 2.

DESIGN CONSIDERATIONS

PIN 3 - C Boost

A capacitor must be connected from pin 3 to the switch output, pin 1. This capacitor boosts the gate drive to the internal MOSFET above V_{IN} to fully turn it ON. This minimizes conduction losses in the power switch to maintain high efficiency. The recommended value for C Boost is 0.01 μ F.

PIN 4 - Ground

This is the ground reference connection for all components in the power supply. In fast-switching, high-current applications such as those implemented with the LM2676, it is recommended that a broad ground plane be used to minimize signal coupling throughout the circuit.

PIN 5 - No Connection

PIN 6 - Feedback

This is the input to a two-stage high gain amplifier, which drives the PWM controller. It is necessary to connect pin 6 to the actual output of the power supply to set the dc output voltage. For the fixed output devices (3.3V, 5V and 12V outputs), a direct wire connection to the output is all that is required as internal gain setting resistors are provided inside the LM2676. For the adjustable output version two external resistors are required to set the dc output voltage. For stable operation of the power supply it is important to prevent coupling of any inductor flux to the feedback input.

PIN 7 - ON/OFF

This input provides an electrical ON/OFF control of the power supply. Connecting this pin to ground or to any voltage less than 0.8V will completely turn OFF the regulator. The current drain from the input supply when OFF is only 50 μ A. Pin 7 has an internal pull-up current source of approximately 20 μ A and a protection clamp zener diode of 7V to ground. When electrically driving the ON/OFF pin the high voltage level for the ON condition should not exceed the 6V absolute maximum limit. When ON/OFF control is not required pin 7 should be left open circuited.

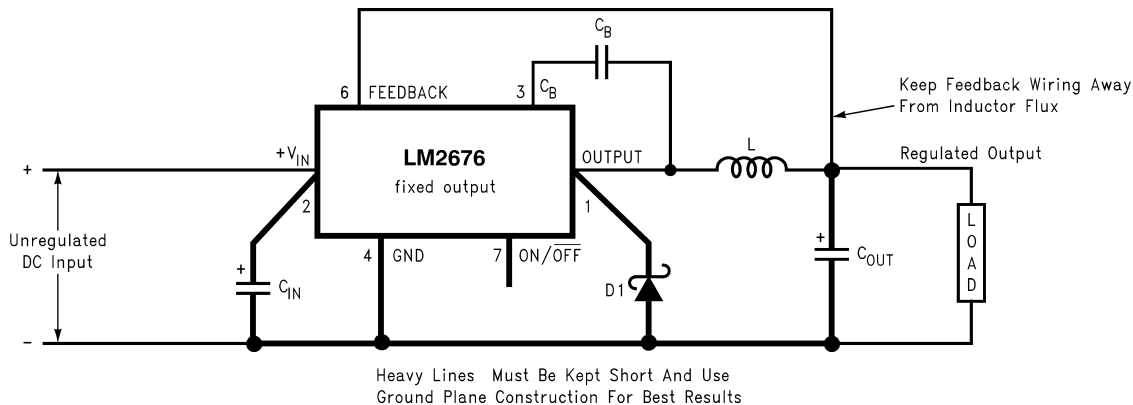

DS100914-7

FIGURE 1. Basic circuit for fixed output voltage applications.

Application Hints (Continued)

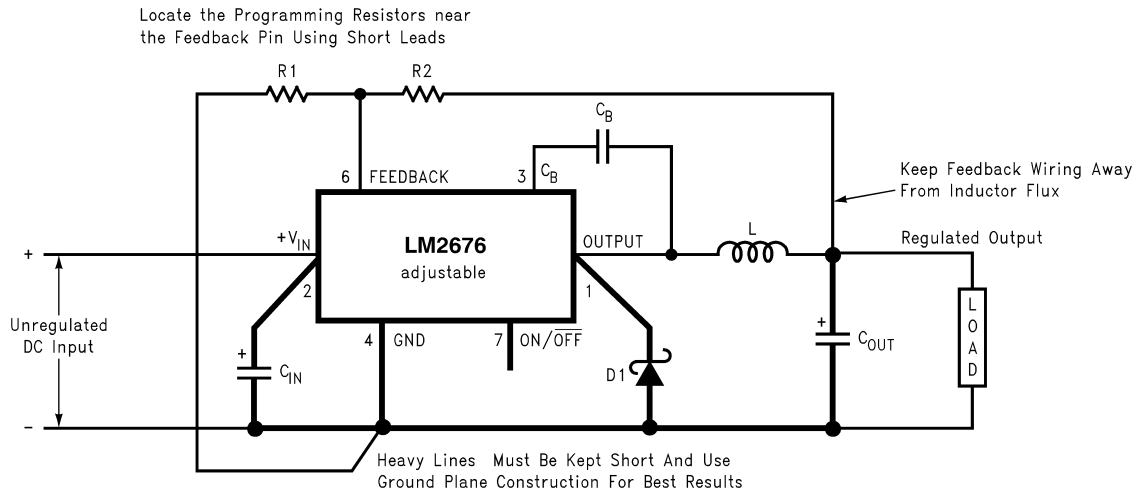

FIGURE 2. Basic circuit for adjustable output voltage applications

Power supply design using the LM2676 is greatly simplified by using recommended external components. A wide range of inductors, capacitors and Schottky diodes from several manufacturers have been evaluated for use in designs that cover the full range of capabilities (input voltage, output voltage and load current) of the LM2676. A simple design procedure using nomographs and component tables provided in this data sheet leads to a working design with very little effort. Alternatively, the design software, **LM267X Made Simple** (version 2.0), can also be used to provide instant component selection, circuit performance calculations for evaluation, a bill of materials component list and a circuit schematic.

The individual components from the various manufacturers called out for use are still just a small sample of the vast array of components available in the industry. While these components are recommended, they are not exclusively the only components for use in a design. After a close comparison of component specifications, equivalent devices from other manufacturers could be substituted for use in an application.

Important considerations for each external component and an explanation of how the nomographs and selection tables were developed follows.

INDUCTOR

The inductor is the key component in a switching regulator. For efficiency the inductor stores energy during the switch ON time and then transfers energy to the load while the switch is OFF.

Nomographs are used to select the inductance value required for a given set of operating conditions. The nomographs assume that the circuit is operating in continuous mode (the current flowing through the inductor never falls to zero). The magnitude of inductance is selected to maintain a maximum ripple current of 30% of the maximum load current. If the ripple current exceeds this 30% limit the next larger value is selected.

The inductors offered have been specifically manufactured to provide proper operation under all operating conditions of input and output voltage and load current. Several part types are offered for a given amount of inductance. Both surface

mount and through-hole devices are available. The inductors from each of the three manufacturers have unique characteristics.

Renco: ferrite stick core inductors; benefits are typically lowest cost and can withstand ripple and transient peak currents above the rated value. These inductors have an external magnetic field, which may generate EMI.

Pulse Engineering: powdered iron toroid core inductors; these also can withstand higher than rated currents and, being toroid inductors, will have low EMI.

Coilcraft: ferrite drum core inductors; these are the smallest physical size inductors and are available only as surface mount components. These inductors also generate EMI but less than stick inductors.

OUTPUT CAPACITOR

The output capacitor acts to smooth the dc output voltage and also provides energy storage. Selection of an output capacitor, with an associated equivalent series resistance (ESR), impacts both the amount of output ripple voltage and stability of the control loop.

The output ripple voltage of the power supply is the product of the capacitor ESR and the inductor ripple current. The capacitor types recommended in the tables were selected for having low ESR ratings.

In addition, both surface mount tantalum capacitors and through-hole aluminum electrolytic capacitors are offered as solutions.

Impacting frequency stability of the overall control loop, the output capacitance, in conjunction with the inductor, creates a double pole inside the feedback loop. In addition the capacitance and the ESR value create a zero. These frequency response effects together with the internal frequency compensation circuitry of the LM2676 modify the gain and phase shift of the closed loop system.

As a general rule for stable switching regulator circuits it is desired to have the unity gain bandwidth of the circuit to be limited to no more than one-sixth of the controller switching frequency. With the fixed 260KHz switching frequency of the LM2676, the output capacitor is selected to provide a unity gain bandwidth of 40KHz maximum. Each recommended capacitor value has been chosen to achieve this result.

Application Hints (Continued)

In some cases multiple capacitors are required either to reduce the ESR of the output capacitor, to minimize output ripple (a ripple voltage of 1% of V_{out} or less is the assumed performance condition), or to increase the output capacitance to reduce the closed loop unity gain bandwidth (to less than 40KHz). When parallel combinations of capacitors are required it has been assumed that each capacitor is the exact same part type.

The RMS current and working voltage (WV) ratings of the output capacitor are also important considerations. In a typical step-down switching regulator, the inductor ripple current (set to be no more than 30% of the maximum load current by the inductor selection) is the current that flows through the output capacitor. The capacitor RMS current rating must be greater than this ripple current. The voltage rating of the output capacitor should be greater than 1.3 times the maximum output voltage of the power supply. If operation of the system at elevated temperatures is required, the capacitor voltage rating may be de-rated to less than the nominal room temperature rating. Careful inspection of the manufacturer's specification for de-rating of working voltage with temperature is important.

INPUT CAPACITOR

Fast changing currents in high current switching regulators place a significant dynamic load on the unregulated power source. An input capacitor helps to provide additional current to the power supply as well as smooth out input voltage variations.

Like the output capacitor, the key specifications for the input capacitor are RMS current rating and working voltage. The RMS current flowing through the input capacitor is equal to one-half of the maximum dc load current so the capacitor should be rated to handle this. Paralleling multiple capacitors proportionally increases the current rating of the total capacitance. The voltage rating should also be selected to be 1.3 times the maximum input voltage. Depending on the unregulated input power source, under light load conditions the maximum input voltage could be significantly higher than normal operation and should be considered when selecting an input capacitor.

The input capacitor should be placed very close to the input pin of the LM2676. Due to relative high current operation with fast transient changes, the series inductance of input connecting wires or PCB traces can create ringing signals at the input terminal which could possibly propagate to the output or other parts of the circuitry. It may be necessary in some designs to add a small valued (0.1 μ F to 0.47 μ F) ceramic type capacitor in parallel with the input capacitor to prevent or minimize any ringing.

CATCH DIODE

When the power switch in the LM2676 turns OFF, the current through the inductor continues to flow. The path for this current is through the diode connected between the switch output and ground. This forward biased diode clamps the switch output to a voltage less than ground. This negative voltage must be greater than $-1V$ so a low voltage drop (particularly at high current levels) Schottky diode is recommended. Total efficiency of the entire power supply is significantly impacted by the power lost in the output catch diode. The average current through the catch diode is dependent on the switch duty cycle (D) and is equal to the load current times (1-D). Use of a diode rated for much higher current than is required by the actual application helps to minimize the voltage drop and power loss in the diode.

During the switch ON time the diode will be reversed biased by the input voltage. The reverse voltage rating of the diode should be at least 1.3 times greater than the maximum input voltage.

BOOST CAPACITOR

The boost capacitor creates a voltage used to overdrive the gate of the internal power MOSFET. This improves efficiency by minimizing the on resistance of the switch and associated power loss. For all applications it is recommended to use a 0.01 μ F/50V ceramic capacitor.

SIMPLE DESIGN PROCEDURE

Using the nomographs and tables in this data sheet (or use the available design software at <http://www.national.com>) a complete step-down regulator can be designed in a few simple steps.

Step 1: Define the power supply operating conditions:

Required output voltage

Maximum DC input voltage

Maximum output load current

Step 2: Set the output voltage by selecting a fixed output LM2676 (3.3V, 5V or 12V applications) or determine the required feedback resistors for use with the adjustable LM2676-ADJ

Step 3: Determine the inductor required by using one of the four nomographs, *Figure 3* through *Figure 6*. Table 1 provides a specific manufacturer and part number for the inductor.

Step 4: Using Table 3 (fixed output voltage) or Table 6 (adjustable output voltage), determine the output capacitance required for stable operation. Table 2 provides the specific capacitor type from the manufacturer of choice.

Step 5: Determine an input capacitor from Table 4 for fixed output voltage applications. Use Table 2 to find the specific capacitor type. For adjustable output circuits select a capacitor from Table 2 with a sufficient working voltage (WV) rating greater than $V_{in\ max}$, and an rms current rating greater than one-half the maximum load current (2 or more capacitors in parallel may be required).

Step 6: Select a diode from Table 5. The current rating of the diode must be greater than $I_{load\ max}$ and the Reverse Voltage rating must be greater than $V_{in\ max}$.

Step 7: Include a 0.01 μ F/50V capacitor for C_{boost} in the design.

FIXED OUTPUT VOLTAGE DESIGN EXAMPLE

A system logic power supply bus of 3.3V is to be generated from a wall adapter which provides an unregulated DC voltage of 13V to 16V. The maximum load current is 2.5A. Through-hole components are preferred.

Step 1: Operating conditions are:

$V_{out} = 3.3V$

$V_{in\ max} = 16V$

$I_{load\ max} = 2.5A$

Step 2: Select an LM2676T-3.3. The output voltage will have a tolerance of

$\pm 2\%$ at room temperature and $\pm 3\%$ over the full operating temperature range.

Step 3: Use the nomograph for the 3.3V device, *Figure 3*. The intersection of the 16V horizontal line ($V_{in\ max}$) and the 2.5A vertical line ($I_{load\ max}$) indicates that L33, a 22 μ H inductor, is required.

Application Hints (Continued)

From Table 1, L33 in a through-hole component is available from Renco with part number RL-1283-22-43 or part number PE-53933 from Pulse Engineering.

Step 4: Use Table 3 to determine an output capacitor. With a 3.3V output and a 22μH inductor there are four through-hole output capacitor solutions with the number of same type capacitors to be paralleled and an identifying capacitor code given. Table 2 provides the actual capacitor characteristics. Any of the following choices will work in the circuit:

- 1 x 220μF/10V Sanyo OS-CON (code C5)
- 1 x 1000μF/35V Sanyo MV-GX (code C10)
- 1 x 2200μF/10V Nichicon PL (code C5)
- 1 x 1000μF/35V Panasonic HFQ (code C7)

Step 5: Use Table 4 to select an input capacitor. With 3.3V output and 22μH there are three through-hole solutions. These capacitors provide a sufficient voltage rating and an rms current rating greater than 1.25A (1/2 $I_{load\ max}$). Again using Table 2 for specific component characteristics the following choices are suitable:

- 1 x 1000μF/63V Sanyo MV-GX (code C14)
- 1 x 820μF/63V Nichicon PL (code C24)
- 1 x 560μF/50V Panasonic HFQ (code C13)

Step 6: From Table 5 a 3A Schottky diode must be selected. For through-hole components 20V rated diodes are sufficient and 2 part types are suitable:

- 1N5820
- SR302

Step 7: A 0.01μF capacitor will be used for Cboost.

ADJUSTABLE OUTPUT DESIGN EXAMPLE

In this example it is desired to convert the voltage from a two battery automotive power supply (voltage range of 20V to 28V, typical in large truck applications) to the 14.8VDC alternator supply typically used to power electronic equipment from single battery 12V vehicle systems. The load current required is 2A maximum. It is also desired to implement the power supply with all surface mount components.

Step 1: Operating conditions are:

- $V_{out} = 14.8V$
- $V_{in\ max} = 28V$
- $I_{load\ max} = 2A$

Step 2: Select an LM2676S-ADJ. To set the output voltage to 14.9V two resistors need to be chosen (R_1 and R_2 in Figure 2). For the adjustable device the output voltage is set by the following relationship:

$$V_{OUT} = V_{FB} \left(1 + \frac{R_2}{R_1} \right)$$

Where V_{FB} is the feedback voltage of typically 1.21V.

A recommended value to use for R_1 is 1K. In this example then R_2 is determined to be:

$$R_2 = R_1 \left(\frac{V_{OUT}}{V_{FB}} - 1 \right) = 1\ k\Omega \left(\frac{14.8V}{1.21V} - 1 \right)$$

$$R_2 = 11.23K\Omega$$

The closest standard 1% tolerance value to use is 11.3KΩ. This will set the nominal output voltage to 14.88V which is within 0.5% of the target value.

Step 3: To use the nomograph for the adjustable device, Figure 6, requires a calculation of the inductor Volt•microsecond constant ($E \cdot T$ expressed in $V \cdot \mu s$) from the following formula:

$$E \cdot T = (V_{IN(MAX)} - V_{OUT} - V_{SAT}) \cdot \frac{V_{OUT} + V_D}{V_{IN(MAX)} - V_{SAT} + V_D} \cdot \frac{1000}{260} (V \cdot \mu s)$$

where V_{SAT} is the voltage drop across the internal power switch which is $R_{ds(ON)}$ times I_{load} . In this example this would be typically $0.15\Omega \times 2A$ or 0.3V and V_D is the voltage drop across the forward biased Schottky diode, typically 0.5V. The switching frequency of 260KHz is the nominal value to use to estimate the ON time of the switch during which energy is stored in the inductor.

For this example $E \cdot T$ is found to be:

$$E \cdot T = (28 - 14.8 - 0.3) \cdot \frac{14.8 + 0.5}{28 - 0.3 + 0.5} \cdot \frac{1000}{260} (V \cdot \mu s)$$

$$E \cdot T = (12.9V) \cdot \frac{15.3}{28.2} \cdot 3.85 (V \cdot \mu s) = 26.9 (V \cdot \mu s)$$

Using Figure 6, the intersection of $27V \cdot \mu s$ horizontally and the 2A vertical line ($I_{load\ max}$) indicates that L38, a 68μH inductor, should be used.

From Table 1, L38 in a surface mount component is available from Pulse Engineering with part number PE-54038S.

Step 4: Use Table 6 to determine an output capacitor. With a 14.8V output the 12.5 to 15V row is used and with a 68μH inductor there are three surface mount output capacitor solutions. Table 2 provides the actual capacitor characteristics based on the C Code number. Any of the following choices can be used:

- 1 x 33μF/20V AVX TPS (code C6)
- 1 x 47μF/20V Sprague 594 (code C8)
- 1 x 47μF/20V Kemet T495 (code C8)

Important Note: When using the adjustable device in low voltage applications (less than 3V output), if the nomograph, Figure 6, selects an inductance of 22μH or less, Table 6 does not provide an output capacitor solution. With these conditions the number of output capacitors required for stable operation becomes impractical. It is recommended to use either a 33μH or 47μH inductor and the output capacitors from Table 6.

Step 5: An input capacitor for this example will require at least a 35V WV rating with an rms current rating of 1A (1/2 $I_{out\ max}$). From Table 2 it can be seen that C12, a 33μF/35V capacitor from Sprague, has the required voltage/current rating of the surface mount components.

Step 6: From Table 5 a 3A Schottky diode must be selected. For surface mount diodes with a margin of safety on the voltage rating one of five diodes can be used:

- SK34
- 30BQ040
- 30WQ04F
- MBR340
- MBRD340

Step 7: A 0.01μF capacitor will be used for Cboost.

Application Hints (Continued)

INDUCTOR VALUE SELECTION GUIDES (For Continuous Mode Operation)

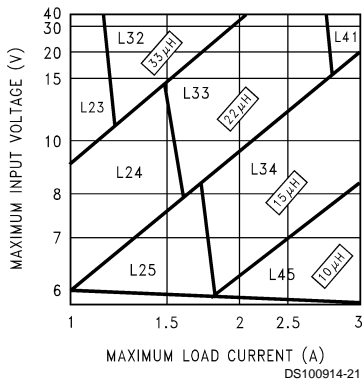

FIGURE 3. LM2676-3.3

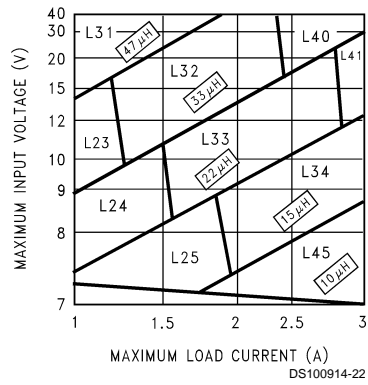

FIGURE 4. LM2676-5.0

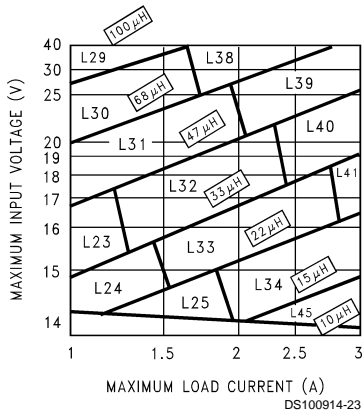

FIGURE 5. LM2676-12

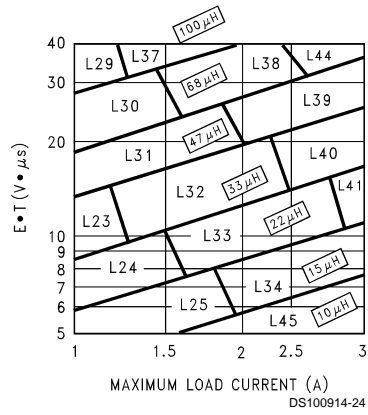

FIGURE 6. LM2676-ADJ

Application Hints (Continued)

Table 1. Inductor Manufacturer Part Numbers

| Inductor Reference Number | Inductance (μH) | Current (A) | Renco | | Pulse Engineering | | Coilcraft |
|---------------------------|------------------------------|-------------|---------------|---------------|-------------------|---------------|---------------|
| | | | Through Hole | Surface Mount | Through Hole | Surface Mount | Surface Mount |
| L23 | 33 | 1.35 | RL-5471-7 | RL1500-33 | PE-53823 | PE-53823S | DO3316-333 |
| L24 | 22 | 1.65 | RL-1283-22-43 | RL1500-22 | PE-53824 | PE-53824S | DO3316-223 |
| L25 | 15 | 2.00 | RL-1283-15-43 | RL1500-15 | PE-53825 | PE-53825S | DO3316-153 |
| L29 | 100 | 1.41 | RL-5471-4 | RL-6050-100 | PE-53829 | PE-53829S | DO5022P-104 |
| L30 | 68 | 1.71 | RL-5471-5 | RL6050-68 | PE-53830 | PE-53830S | DO5022P-683 |
| L31 | 47 | 2.06 | RL-5471-6 | RL6050-47 | PE-53831 | PE-53831S | DO5022P-473 |
| L32 | 33 | 2.46 | RL-5471-7 | RL6050-33 | PE-53932 | PE-53932S | DO5022P-333 |
| L33 | 22 | 3.02 | RL-1283-22-43 | RL6050-22 | PE-53933 | PE-53933S | DO5022P-223 |
| L34 | 15 | 3.65 | RL-1283-15-43 | — | PE-53934 | PE-53934S | DO5022P-153 |
| L38 | 68 | 2.97 | RL-5472-2 | — | PE-54038 | PE-54038S | — |
| L39 | 47 | 3.57 | RL-5472-3 | — | PE-54039 | PE-54039S | — |
| L40 | 33 | 4.26 | RL-1283-33-43 | — | PE-54040 | PE-54040S | — |
| L41 | 22 | 5.22 | RL-1283-22-43 | — | PE-54041 | P0841 | — |
| L44 | 68 | 3.45 | RL-5473-3 | — | PE-54044 | — | — |
| L45 | 10 | 4.47 | RL-1283-10-43 | — | — | P0845 | DO5022P-103HC |

Inductor Manufacturer Contact Numbers

| | | |
|----------------------------------|-------|------------------|
| Coilcraft | Phone | (800) 322-2645 |
| | FAX | (708) 639-1469 |
| Coilcraft, Europe | Phone | +44 1236 730 595 |
| | FAX | +44 1236 730 627 |
| Pulse Engineering | Phone | (619) 674-8100 |
| | FAX | (619) 674-8262 |
| Pulse Engineering, Europe | Phone | +353 93 24 107 |
| | FAX | +353 93 24 459 |
| Renco Electronics | Phone | (800) 645-5828 |
| | FAX | (516) 586-5562 |

Application Hints (Continued)

Table 2. Input and Output Capacitor Codes

| Capacitor Reference Code | Surface Mount | | | | | | | | |
|--------------------------|----------------|--------|----------------------|---------------------|--------|----------------------|-------------------|--------|----------------------|
| | AVX TPS Series | | | Sprague 594D Series | | | Kemet T495 Series | | |
| | C (μF) | WV (V) | I _{rms} (A) | C (μF) | WV (V) | I _{rms} (A) | C (μF) | WV (V) | I _{rms} (A) |
| C1 | 330 | 6.3 | 1.15 | 120 | 6.3 | 1.1 | 100 | 6.3 | 0.82 |
| C2 | 100 | 10 | 1.1 | 220 | 6.3 | 1.4 | 220 | 6.3 | 1.1 |
| C3 | 220 | 10 | 1.15 | 68 | 10 | 1.05 | 330 | 6.3 | 1.1 |
| C4 | 47 | 16 | 0.89 | 150 | 10 | 1.35 | 100 | 10 | 1.1 |
| C5 | 100 | 16 | 1.15 | 47 | 16 | 1 | 150 | 10 | 1.1 |
| C6 | 33 | 20 | 0.77 | 100 | 16 | 1.3 | 220 | 10 | 1.1 |
| C7 | 68 | 20 | 0.94 | 180 | 16 | 1.95 | 33 | 20 | 0.78 |
| C8 | 22 | 25 | 0.77 | 47 | 20 | 1.15 | 47 | 20 | 0.94 |
| C9 | 10 | 35 | 0.63 | 33 | 25 | 1.05 | 68 | 20 | 0.94 |
| C10 | 22 | 35 | 0.66 | 68 | 25 | 1.6 | 10 | 35 | 0.63 |
| C11 | | | | 15 | 35 | 0.75 | 22 | 35 | 0.63 |
| C12 | | | | 33 | 35 | 1 | 4.7 | 50 | 0.66 |
| C13 | | | | 15 | 50 | 0.9 | | | |

Application Hints (Continued)**Table 2. Input and Output Capacitor Codes (continued)**

| Capacitor Reference Code | Through Hole | | | | | | | | | | | |
|--------------------------|------------------------|--------|----------|--------------------|--------|----------|--------------------|--------|----------|----------------------|--------|----------|
| | Sanyo OS-CON SA Series | | | Sanyo MV-GX Series | | | Nichicon PL Series | | | Panasonic HFQ Series | | |
| | C (μF) | WV (V) | Irms (A) | C (μF) | WV (V) | Irms (A) | C (μF) | WV (V) | Irms (A) | C (μF) | WV (V) | Irms (A) |
| C1 | 47 | 6.3 | 1 | 1000 | 6.3 | 0.8 | 680 | 10 | 0.8 | 82 | 35 | 0.4 |
| C2 | 150 | 6.3 | 1.95 | 270 | 16 | 0.6 | 820 | 10 | 0.98 | 120 | 35 | 0.44 |
| C3 | 330 | 6.3 | 2.45 | 470 | 16 | 0.75 | 1000 | 10 | 1.06 | 220 | 35 | 0.76 |
| C4 | 100 | 10 | 1.87 | 560 | 16 | 0.95 | 1200 | 10 | 1.28 | 330 | 35 | 1.01 |
| C5 | 220 | 10 | 2.36 | 820 | 16 | 1.25 | 2200 | 10 | 1.71 | 560 | 35 | 1.4 |
| C6 | 33 | 16 | 0.96 | 1000 | 16 | 1.3 | 3300 | 10 | 2.18 | 820 | 35 | 1.62 |
| C7 | 100 | 16 | 1.92 | 150 | 35 | 0.65 | 3900 | 10 | 2.36 | 1000 | 35 | 1.73 |
| C8 | 150 | 16 | 2.28 | 470 | 35 | 1.3 | 6800 | 10 | 2.68 | 2200 | 35 | 2.8 |
| C9 | 100 | 20 | 2.25 | 680 | 35 | 1.4 | 180 | 16 | 0.41 | 56 | 50 | 0.36 |
| C10 | 47 | 25 | 2.09 | 1000 | 35 | 1.7 | 270 | 16 | 0.55 | 100 | 50 | 0.5 |
| C11 | | | | 220 | 63 | 0.76 | 470 | 16 | 0.77 | 220 | 50 | 0.92 |
| C12 | | | | 470 | 63 | 1.2 | 680 | 16 | 1.02 | 470 | 50 | 1.44 |
| C13 | | | | 680 | 63 | 1.5 | 820 | 16 | 1.22 | 560 | 50 | 1.68 |
| C14 | | | | 1000 | 63 | 1.75 | 1800 | 16 | 1.88 | 1200 | 50 | 2.22 |
| C15 | | | | | | | 220 | 25 | 0.63 | 330 | 63 | 1.42 |
| C16 | | | | | | | 220 | 35 | 0.79 | 1500 | 63 | 2.51 |
| C17 | | | | | | | 560 | 35 | 1.43 | | | |
| C18 | | | | | | | 2200 | 35 | 2.68 | | | |
| C19 | | | | | | | 150 | 50 | 0.82 | | | |
| C20 | | | | | | | 220 | 50 | 1.04 | | | |
| C21 | | | | | | | 330 | 50 | 1.3 | | | |
| C22 | | | | | | | 100 | 63 | 0.75 | | | |
| C23 | | | | | | | 390 | 63 | 1.62 | | | |
| C24 | | | | | | | 820 | 63 | 2.22 | | | |
| C25 | | | | | | | 1200 | 63 | 2.51 | | | |

Capacitor Manufacturer Contact Numbers

| | | |
|-----------------------|-------|----------------|
| Nichicon | Phone | (847) 843-7500 |
| | FAX | (847) 843-2798 |
| Panasonic | Phone | (714) 373-7857 |
| | FAX | (714) 373-7102 |
| AVX | Phone | (845) 448-9411 |
| | FAX | (845) 448-1943 |
| Sprague/Vishay | Phone | (207) 324-4140 |
| | FAX | (207) 324-7223 |
| Sanyo | Phone | (619) 661-6322 |
| | FAX | (619) 661-1055 |
| Kemet | Phone | (864) 963-6300 |
| | FAX | (864) 963-6521 |

Application Hints (Continued)

Table 3. Output Capacitors for Fixed Output Voltage Application

| Output Voltage (V) | Inductance (μ H) | Surface Mount | | | | | |
|--------------------|-----------------------|----------------|--------|---------------------|--------|-------------------|--------|
| | | AVX TPS Series | | Sprague 594D Series | | Kemet T495 Series | |
| | | No. | C Code | No. | C Code | No. | C Code |
| 3.3 | 10 | 4 | C2 | 3 | C1 | 4 | C4 |
| | 15 | 4 | C2 | 3 | C1 | 4 | C4 |
| | 22 | 3 | C2 | 2 | C7 | 3 | C4 |
| | 33 | 2 | C2 | 2 | C6 | 2 | C4 |
| 5 | 10 | 4 | C2 | 4 | C6 | 4 | C4 |
| | 15 | 3 | C2 | 2 | C7 | 3 | C4 |
| | 22 | 3 | C2 | 2 | C7 | 3 | C4 |
| | 33 | 2 | C2 | 2 | C3 | 2 | C4 |
| | 47 | 2 | C2 | 1 | C7 | 2 | C4 |
| 12 | 10 | 4 | C5 | 3 | C6 | 5 | C9 |
| | 15 | 3 | C5 | 2 | C7 | 4 | C8 |
| | 22 | 2 | C5 | 2 | C6 | 3 | C8 |
| | 33 | 2 | C5 | 1 | C7 | 2 | C8 |
| | 47 | 2 | C4 | 1 | C6 | 2 | C8 |
| | 68 | 1 | C5 | 1 | C5 | 2 | C7 |
| | 100 | 1 | C4 | 1 | C5 | 1 | C8 |

| Output Voltage (V) | Inductance (μ H) | Through Hole | | | | | | | |
|--------------------|-----------------------|------------------------|--------|--------------------|--------|--------------------|--------|----------------------|--------|
| | | Sanyo OS-CON SA Series | | Sanyo MV-GX Series | | Nichicon PL Series | | Panasonic HFQ Series | |
| | | No. | C Code | No. | C Code | No. | C Code | No. | C Code |
| 3.3 | 10 | 1 | C3 | 1 | C10 | 1 | C6 | 2 | C6 |
| | 15 | 1 | C3 | 1 | C10 | 1 | C6 | 2 | C5 |
| | 22 | 1 | C5 | 1 | C10 | 1 | C5 | 1 | C7 |
| | 33 | 1 | C2 | 1 | C10 | 1 | C13 | 1 | C5 |
| 5 | 10 | 2 | C4 | 1 | C10 | 1 | C6 | 2 | C5 |
| | 15 | 1 | C5 | 1 | C10 | 1 | C5 | 1 | C6 |
| | 22 | 1 | C5 | 1 | C5 | 1 | C5 | 1 | C5 |
| | 33 | 1 | C4 | 1 | C5 | 1 | C13 | 1 | C5 |
| | 47 | 1 | C4 | 1 | C4 | 1 | C13 | 2 | C3 |
| 12 | 10 | 2 | C7 | 1 | C5 | 1 | C18 | 2 | C5 |
| | 15 | 1 | C8 | 1 | C5 | 1 | C17 | 1 | C5 |
| | 22 | 1 | C7 | 1 | C5 | 1 | C13 | 1 | C5 |
| | 33 | 1 | C7 | 1 | C3 | 1 | C11 | 1 | C4 |
| | 47 | 1 | C7 | 1 | C3 | 1 | C10 | 1 | C3 |
| | 68 | 1 | C7 | 1 | C2 | 1 | C10 | 1 | C3 |
| | 100 | 1 | C7 | 1 | C2 | 1 | C9 | 1 | C1 |

No. represents the number of identical capacitor types to be connected in parallel

C Code indicates the Capacitor Reference number in Table 2 for identifying the specific component from the manufacturer.

Application Hints (Continued)

Table 4. Input Capacitors for Fixed Output Voltage Application

(Assumes worst case maximum input voltage and load current for a given inductance value)

| Output Voltage (V) | Inductance (μ H) | Surface Mount | | | | | |
|--------------------|-----------------------|----------------|--------|---------------------|--------|-------------------|--------|
| | | AVX TPS Series | | Sprague 594D Series | | Kemet T495 Series | |
| | | No. | C Code | No. | C Code | No. | C Code |
| 3.3 | 10 | 2 | C5 | 1 | C7 | 2 | C8 |
| | 15 | 3 | C9 | 1 | C10 | 3 | C10 |
| | 22 | * | * | 2 | C13 | 3 | C12 |
| | 33 | * | * | 2 | C13 | 2 | C12 |
| 5 | 10 | 2 | C5 | 1 | C7 | 2 | C8 |
| | 15 | 2 | C5 | 1 | C7 | 2 | C8 |
| | 22 | 3 | C10 | 2 | C12 | 3 | C11 |
| | 33 | * | * | 2 | C13 | 3 | C12 |
| | 47 | * | * | 1 | C13 | 2 | C12 |
| 12 | 10 | 2 | C7 | 2 | C10 | 2 | C7 |
| | 15 | 2 | C7 | 2 | C10 | 2 | C7 |
| | 22 | 3 | C10 | 2 | C12 | 3 | C10 |
| | 33 | 3 | C10 | 2 | C12 | 3 | C10 |
| | 47 | * | * | 2 | C13 | 3 | C12 |
| | 68 | * | * | 2 | C13 | 2 | C12 |
| | 100 | * | * | 1 | C13 | 2 | C12 |

| Output Voltage (V) | Inductance (μ H) | Through Hole | | | | | | | |
|--------------------|-----------------------|------------------------|--------|--------------------|--------|--------------------|--------|----------------------|--------|
| | | Sanyo OS-CON SA Series | | Sanyo MV-GX Series | | Nichicon PL Series | | Panasonic HFQ Series | |
| | | No. | C Code | No. | C Code | No. | C Code | No. | C Code |
| 3.3 | 10 | 1 | C7 | 2 | C4 | 1 | C5 | 1 | C6 |
| | 15 | 1 | C10 | 1 | C10 | 1 | C18 | 1 | C6 |
| | 22 | * | * | 1 | C14 | 1 | C24 | 1 | C13 |
| | 33 | * | * | 1 | C12 | 1 | C20 | 1 | C12 |
| 5 | 10 | 1 | C7 | 2 | C4 | 1 | C14 | 1 | C6 |
| | 15 | 1 | C7 | 2 | C4 | 1 | C14 | 1 | C6 |
| | 22 | * | * | 1 | C10 | 1 | C18 | 1 | C13 |
| | 33 | * | * | 1 | C14 | 1 | C23 | 1 | C13 |
| | 47 | * | * | 1 | C12 | 1 | C20 | 1 | C12 |
| 12 | 10 | 1 | C9 | 1 | C10 | 1 | C18 | 1 | C6 |
| | 15 | 1 | C10 | 1 | C10 | 1 | C18 | 1 | C6 |
| | 22 | 1 | C10 | 1 | C10 | 1 | C18 | 1 | C6 |
| | 33 | * | * | 1 | C10 | 1 | C18 | 1 | C6 |
| | 47 | * | * | 1 | C13 | 1 | C23 | 1 | C13 |
| | 68 | * | * | 1 | C12 | 1 | C21 | 1 | C12 |
| | 100 | * | * | 1 | C11 | 1 | C22 | 1 | C11 |

* Check voltage rating of capacitors to be greater than application input voltage.

No. represents the number of identical capacitor types to be connected in parallel

C Code indicates the Capacitor Reference number in Table 2 for identifying the specific component from the manufacturer.

Application Hints (Continued)**Table 5. Schottky Diode Selection Table**

| Reverse Voltage (V) | Surface Mount | | Through Hole | |
|---------------------|--|-----------------------|-------------------------------------|-----------------------------|
| | 3A | 5A or More | 3A | 5A or More |
| 20V | SK32 | | 1N5820 SR302 | |
| 30V | SK33 30WQ03F | MBRD835L | 1N5821 31DQ03 | |
| 40V | SK34 30BQ040 30WQ04F MBRS340 MBRD340 | MBRB1545CT 6TQ045S | 1N5822 MBR340 31DQ04 SR403 | MBR745 80SQ045 6TQ045 |
| 50V or More | SK35 30WQ05F | | MBR350 31DQ05 SR305 | |

Diode Manufacturer Contact Numbers

| | | |
|--------------------------------|-------|----------------|
| International Rectifier | Phone | (310) 322-3331 |
| | FAX | (310) 322-3332 |
| Motorola | Phone | (800) 521-6274 |
| | FAX | (602) 244-6609 |
| General Semiconductor | Phone | (516) 847-3000 |
| | FAX | (516) 847-3236 |
| Diodes, Inc. | Phone | (805) 446-4800 |
| | FAX | (805) 446-4850 |

Application Hints (Continued)

Table 6. Output Capacitors for Adjustable Output Voltage Applications

| Output Voltage (V) | Inductance (μH) | Surface Mount | | | | | |
|--------------------|------------------------------|---------------------|--------|---------------------|--------|-------------------|--------|
| | | AVX TPS Series | | Sprague 594D Series | | Kemet T495 Series | |
| | | No. | C Code | No. | C Code | No. | C Code |
| 1.21 to 2.50 | 33* | 7 | C1 | 6 | C2 | 7 | C3 |
| | 47* | 5 | C1 | 4 | C2 | 5 | C3 |
| 2.5 to 3.75 | 33* | 4 | C1 | 3 | C2 | 4 | C3 |
| | 47* | 3 | C1 | 2 | C2 | 3 | C3 |
| 3.75 to 5 | 22 | 4 | C1 | 3 | C2 | 4 | C3 |
| | 33 | 3 | C1 | 2 | C2 | 3 | C3 |
| | 47 | 2 | C1 | 2 | C2 | 2 | C3 |
| 5 to 6.25 | 22 | 3 | C2 | 3 | C3 | 3 | C4 |
| | 33 | 2 | C2 | 2 | C3 | 2 | C4 |
| | 47 | 2 | C2 | 2 | C3 | 2 | C4 |
| | 68 | 1 | C2 | 1 | C3 | 1 | C4 |
| 6.25 to 7.5 | 22 | 3 | C2 | 1 | C4 | 3 | C4 |
| | 33 | 2 | C2 | 1 | C3 | 2 | C4 |
| | 47 | 1 | C3 | 1 | C4 | 1 | C6 |
| | 68 | 1 | C2 | 1 | C3 | 1 | C4 |
| 7.5 to 10 | 33 | 2 | C5 | 1 | C6 | 2 | C8 |
| | 47 | 1 | C5 | 1 | C6 | 2 | C8 |
| | 68 | 1 | C5 | 1 | C6 | 1 | C8 |
| | 100 | 1 | C4 | 1 | C5 | 1 | C8 |
| 10 to 12.5 | 33 | 1 | C5 | 1 | C6 | 2 | C8 |
| | 47 | 1 | C5 | 1 | C6 | 2 | C8 |
| | 68 | 1 | C5 | 1 | C6 | 1 | C8 |
| | 100 | 1 | C5 | 1 | C6 | 1 | C8 |
| 12.5 to 15 | 33 | 1 | C6 | 1 | C8 | 1 | C8 |
| | 47 | 1 | C6 | 1 | C8 | 1 | C8 |
| | 68 | 1 | C6 | 1 | C8 | 1 | C8 |
| | 100 | 1 | C6 | 1 | C8 | 1 | C8 |
| 15 to 20 | 33 | 1 | C8 | 1 | C10 | 2 | C10 |
| | 47 | 1 | C8 | 1 | C9 | 2 | C10 |
| | 68 | 1 | C8 | 1 | C9 | 2 | C10 |
| | 100 | 1 | C8 | 1 | C9 | 1 | C10 |
| 20 to 30 | 33 | 2 | C9 | 2 | C11 | 2 | C11 |
| | 47 | 1 | C10 | 1 | C12 | 1 | C11 |
| | 68 | 1 | C9 | 1 | C12 | 1 | C11 |
| | 100 | 1 | C9 | 1 | C12 | 1 | C11 |
| 30 to 37 | 10 | No Values Available | | 4 | C13 | 8 | C12 |
| | 15 | | | 3 | C13 | 5 | C12 |
| | 22 | | | 2 | C13 | 4 | C12 |
| | 33 | | | 1 | C13 | 3 | C12 |
| | 47 | | | 1 | C13 | 2 | C12 |
| | 68 | | | 1 | C13 | 2 | C12 |

Application Hints (Continued)

Table 6. Output Capacitors for Adjustable Output Voltage Applications (continued)

| Output Voltage (V) | Inductance (μH) | Through Hole | | | | | | | |
|--------------------|-----------------|------------------------|--------|--------------------|--------|--------------------|--------|----------------------|--------|
| | | Sanyo OS-CON SA Series | | Sanyo MV-GX Series | | Nichicon PL Series | | Panasonic HFQ Series | |
| | | No. | C Code | No. | C Code | No. | C Code | No. | C Code |
| 1.21 to 2.50 | 33* | 2 | C3 | 5 | C1 | 5 | C3 | 3 | C |
| | 47* | 2 | C2 | 4 | C1 | 3 | C3 | 2 | C5 |
| 2.5 to 3.75 | 33* | 1 | C3 | 3 | C1 | 3 | C1 | 2 | C5 |
| | 47* | 1 | C2 | 2 | C1 | 2 | C3 | 1 | C5 |
| 3.75 to 5 | 22 | 1 | C3 | 3 | C1 | 3 | C1 | 2 | C5 |
| | 33 | 1 | C2 | 2 | C1 | 2 | C1 | 1 | C5 |
| | 47 | 1 | C2 | 2 | C1 | 1 | C3 | 1 | C5 |
| 5 to 6.25 | 22 | 1 | C5 | 2 | C6 | 2 | C3 | 2 | C5 |
| | 33 | 1 | C4 | 1 | C6 | 2 | C1 | 1 | C5 |
| | 47 | 1 | C4 | 1 | C6 | 1 | C3 | 1 | C5 |
| | 68 | 1 | C4 | 1 | C6 | 1 | C1 | 1 | C5 |
| 6.25 to 7.5 | 22 | 1 | C5 | 1 | C6 | 2 | C1 | 1 | C5 |
| | 33 | 1 | C4 | 1 | C6 | 1 | C3 | 1 | C5 |
| | 47 | 1 | C4 | 1 | C6 | 1 | C1 | 1 | C5 |
| | 68 | 1 | C4 | 1 | C2 | 1 | C1 | 1 | C5 |
| 7.5 to 10 | 33 | 1 | C7 | 1 | C6 | 1 | C14 | 1 | C5 |
| | 47 | 1 | C7 | 1 | C6 | 1 | C14 | 1 | C5 |
| | 68 | 1 | C7 | 1 | C2 | 1 | C14 | 1 | C2 |
| | 100 | 1 | C7 | 1 | C2 | 1 | C14 | 1 | C2 |
| 10 to 12.5 | 33 | 1 | C7 | 1 | C6 | 1 | C14 | 1 | C5 |
| | 47 | 1 | C7 | 1 | C2 | 1 | C14 | 1 | C5 |
| | 68 | 1 | C7 | 1 | C2 | 1 | C9 | 1 | C2 |
| | 100 | 1 | C7 | 1 | C2 | 1 | C9 | 1 | C2 |
| 12.5 to 15 | 33 | 1 | C9 | 1 | C10 | 1 | C15 | 1 | C2 |
| | 47 | 1 | C9 | 1 | C10 | 1 | C15 | 1 | C2 |
| | 68 | 1 | C9 | 1 | C10 | 1 | C15 | 1 | C2 |
| | 100 | 1 | C9 | 1 | C10 | 1 | C15 | 1 | C2 |
| 15 to 20 | 33 | 1 | C10 | 1 | C7 | 1 | C15 | 1 | C2 |
| | 47 | 1 | C10 | 1 | C7 | 1 | C15 | 1 | C2 |
| | 68 | 1 | C10 | 1 | C7 | 1 | C15 | 1 | C2 |
| | 100 | 1 | C10 | 1 | C7 | 1 | C15 | 1 | C2 |
| 20 to 30 | 33 | No Values Available | | 1 | C7 | 1 | C16 | 1 | C2 |
| | 47 | | | 1 | C7 | 1 | C16 | 1 | C2 |
| | 68 | | | 1 | C7 | 1 | C16 | 1 | C2 |
| | 100 | | | 1 | C7 | 1 | C16 | 1 | C2 |
| 30 to 37 | 10 | No Values Available | | 1 | C12 | 1 | C20 | 1 | C10 |
| | 15 | | | 1 | C11 | 1 | C20 | 1 | C11 |
| | 22 | | | 1 | C11 | 1 | C20 | 1 | C10 |
| | 33 | | | 1 | C11 | 1 | C20 | 1 | C10 |
| | 47 | | | 1 | C11 | 1 | C20 | 1 | C10 |
| | 68 | | | 1 | C11 | 1 | C20 | 1 | C10 |

* Set to a higher value for a practical design solution. See Applications Hints section

No. represents the number of identical capacitor types to be connected in parallel

C Code indicates the Capacitor Reference number in Table 2 for identifying the specific component from the manufacturer.

Physical Dimensions inches (millimeters) unless otherwise noted

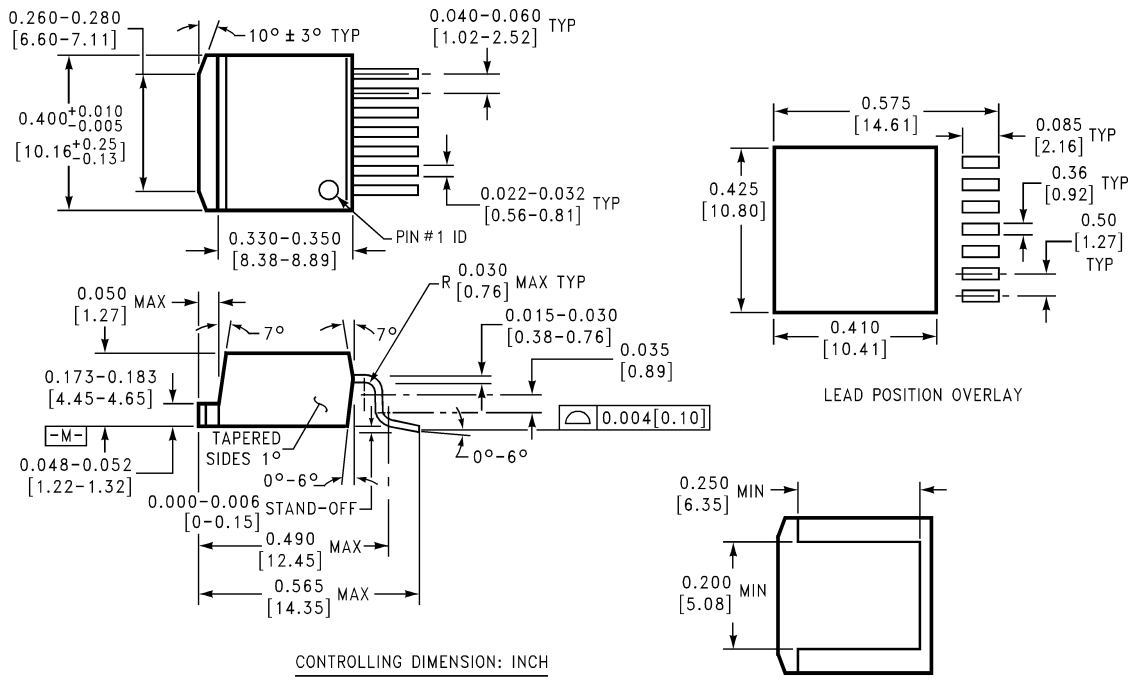

TO-263 Surface Mount Power Package
Order Number LM2676S-3.3, LM2676S-5.0,
LM2676S-12 or LM2676S-ADJ
NS Package Number TS7B

BACK VIEW

TS7B (REV B)

Physical Dimensions inches (millimeters) unless otherwise noted (Continued)

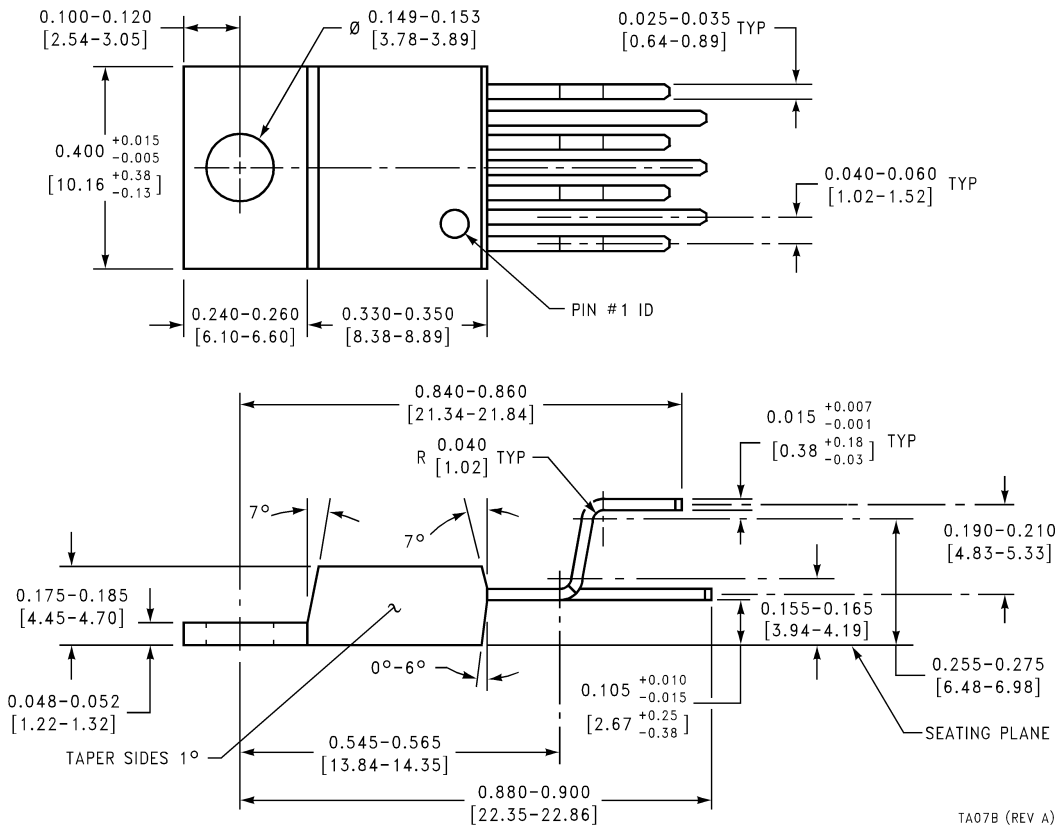

TO-220 Power Package
Order Number LM2676T-3.3, LM2676T-5.0,
LM2676T-12 or LM2676T-ADJ
NS Package Number TA07B

LIFE SUPPORT POLICY

NATIONAL'S PRODUCTS ARE NOT AUTHORIZED FOR USE AS CRITICAL COMPONENTS IN LIFE SUPPORT DEVICES OR SYSTEMS WITHOUT THE EXPRESS WRITTEN APPROVAL OF THE PRESIDENT AND GENERAL COUNSEL OF NATIONAL SEMICONDUCTOR CORPORATION. As used herein:

1. Life support devices or systems are devices or systems which, (a) are intended for surgical implant into the body, or (b) support or sustain life, and whose failure to perform when properly used in accordance with instructions for use provided in the labeling, can be reasonably expected to result in a significant injury to the user.
2. A critical component is any component of a life support device or system whose failure to perform can be reasonably expected to cause the failure of the life support device or system, or to affect its safety or effectiveness.

National Semiconductor Corporation
 Americas
 Tel: 1-800-272-9959
 Fax: 1-800-737-7018
 Email: support@nsc.com
 www.national.com

National Semiconductor Europe
 Fax: +49 (0) 180-530 85 86
 Email: europe.support@nsc.com
 Deutsch Tel: +49 (0) 69 9508 6208
 English Tel: +44 (0) 870 24 0 2171
 Français Tel: +33 (0) 1 41 91 8790

National Semiconductor Asia Pacific Customer Response Group
 Tel: 65-2544466
 Fax: 65-2504466
 Email: ap.support@nsc.com

National Semiconductor Japan Ltd.
 Tel: 81-3-5639-7560
 Fax: 81-3-5639-7507