

## LM3480

### 100 mA, SOT-23, Quasi Low-Dropout Linear Voltage Regulator

#### General Description

The LM3480 is an integrated linear voltage regulator. It features operation from an input as high as 30V and a guaranteed maximum dropout of 1.2V at the full 100 mA load. Standard packaging for the LM3480 is the 3-lead SuperSOT® package.

The 5, 12, and 15V members of the LM3480 series are intended as tiny alternatives to industry standard LM78LXX series and similar devices. The 1.2V quasi low dropout of LM3480 series devices makes them a nice fit in many applications where the 2 to 2.5V dropout of LM78LXX series devices precludes their (LM78LXX series devices) use.

The LM3480 series features a 3.3V member. The SOT packaging and quasi low dropout features of the LM3480 series converge in this device to provide a very nice, very tiny 3.3V, 100 mA bias supply that regulates directly off the system 5V±5% power supply.

#### Key Specifications

- 30V maximum input for operation
- 1.2V guaranteed maximum dropout over full load and temperature ranges
- 100 mA guaranteed minimum load current
- ±5% guaranteed output voltage tolerance over full load and temperature ranges
- -40 to +125°C junction temperature range for operation

#### Features

- 3.3, 5, 12, and 15V versions available
- Packaged in the tiny 3-lead SuperSOT package

#### Applications

- Tiny alternative to LM78LXX series and similar devices
- Tiny 5V±5% to 3.3V, 100 mA converter
- Post regulator for switching DC/DC converter
- Bias supply for analog circuits

#### Typical Application Circuit

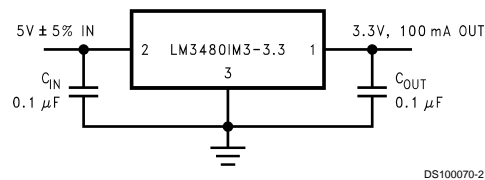

#### Connection Diagram

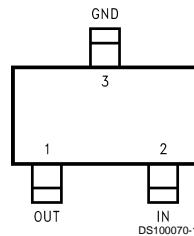

**Top View**  
**SOT-23 Package**  
**3-Lead, Molded-Plastic Small-Outline Transistor (SOT) Package**  
**Package Code MA03B (Note 1)**

## Ordering Information

Output Voltage (V)	Order Number (Note 2)	Package Marking (Note 3)	Comments
3.3	LM3480IM3-3.3	LOA	250 Units on Tape and Reel
3.3	LM3480IM3X-3.3	LOA	3k Units on Tape and Reel
5	LM3480IM3-5.0	LOB	250 Units on Tape and Reel
5	LM3480IM3X-5.0	LOB	3k Units on Tape and Reel
12	LM3480IM3-12	L0C	250 Units on Tape and Reel
12	LM3480IM3X-12	L0C	3k Units on Tape and Reel
15	LM3480IM3-15	L0D	250 Units on Tape and Reel
15	LM3480IM3X-15	L0D	3k Units on Tape and Reel

## Absolute Maximum Ratings (Note 4)

If Military/Aerospace specified devices are required, please contact the National Semiconductor Sales Office/Distributors for availability and specifications.

Input Voltage (IN to GND)	35V
Power Dissipation (Note 5)	333mW
Junction Temp. (Note 5)	+150°C
Ambient Storage Temp.	-65 to +150°C
Soldering Time, Temp. (Note 6)	
Wave	4 sec., 260°C
Infrared	10 sec., 240°C
Vapor Phase	75 sec., 219°C

ESD (Note 7)

2kV

## Operating Ratings (Note 4)

Max. Input Voltage (IN to GND)	30V
Junction Temp. (T <sub>J</sub> )	-40 to +125°C
Max. Power Dissipation (Note 8)	250mW

## Electrical Characteristics

### LM3480-3.3, LM3480-5.0

Typicals and limits appearing in normal type apply for T<sub>A</sub> = T<sub>J</sub> = 25°C. Limits appearing in boldface type apply over the entire junction temperature range for operation, -40 to +125°C. (Notes 9, 10, 11)

Nominal Output Voltage (V <sub>NOM</sub> )			3.3V		5.0V		Units
Symbol	Parameter	Conditions	Typical	Limit	Typical	Limit	
V <sub>OUT</sub>	Output Voltage	V <sub>IN</sub> = V <sub>NOM</sub> + 1.5V, 1 mA ≤ I <sub>OUT</sub> ≤ 100 mA	3.30	3.17 <b>3.14</b> 3.43 <b>3.46</b>	5.00	4.80 <b>4.75</b> 5.20 <b>5.25</b>	V V(min) V(min) V(max) V(max)
ΔV <sub>OUT</sub>	Line Regulation	V <sub>NOM</sub> + 1.5V ≤ V <sub>IN</sub> ≤ 30V, I <sub>OUT</sub> = 1 mA	10	<b>25</b>	12	<b>25</b>	mV mV(max)
ΔV <sub>OUT</sub>	Load Regulation	V <sub>IN</sub> = V <sub>NOM</sub> + 1.5V, 10 mA ≤ I <sub>OUT</sub> ≤ 100 mA	20	<b>40</b>	20	<b>40</b>	mV mV(max)
I <sub>GND</sub>	Ground Pin Current	V <sub>NOM</sub> + 1.5V ≤ V <sub>IN</sub> ≤ 30V, No Load	2	<b>4</b>	2	<b>4</b>	mA mA(max)
V <sub>IN</sub> - V <sub>OUT</sub>	Dropout Voltage	I <sub>OUT</sub> = 10 mA  I <sub>OUT</sub> = 100 mA	0.7  0.9	0.9 <b>1.0</b> 1.1 <b>1.2</b>	0.7  0.9	0.9 <b>1.0</b> 1.1 <b>1.2</b>	V V(max) V(max) V V(max) V(max)
e <sub>n</sub>	Output Noise Voltage	V <sub>IN</sub> = 10V, Bandwidth: 10 Hz to 100 kHz	100		150		μV <sub>rms</sub>

## LM3480-12, LM3480-15

Typicals and limits appearing in normal type apply for  $T_A = T_J = 25^\circ\text{C}$ . Limits appearing in boldface type apply over the entire junction temperature range for operation,  $-40$  to  $+125^\circ\text{C}$ . (Notes 9, 10, 11)

Nominal Output Voltage ( $V_{\text{NOM}}$ )			12V		15V		Units
Symbol	Parameter	Conditions	Typical	Limit	Typical	Limit	
$V_{\text{OUT}}$	Output Voltage	$V_{\text{IN}} = V_{\text{NOM}} + 1.5\text{V}$ , $1\text{ mA} \leq I_{\text{OUT}} \leq 100\text{ mA}$	12.00	11.52 <b>11.40</b> 12.48 <b>12.60</b>	15.00	14.40 <b>14.25</b> 15.60 <b>15.75</b>	V V(min) V(min) V(max) V(max)
$\Delta V_{\text{OUT}}$	Line Regulation	$V_{\text{NOM}} + 1.5\text{V} \leq V_{\text{IN}} \leq 30\text{V}$ , $I_{\text{OUT}} = 1\text{ mA}$	14	<b>40</b>	16	<b>40</b>	mV mV(max)
$\Delta V_{\text{OUT}}$	Load Regulation	$V_{\text{IN}} = V_{\text{NOM}} + 1.5\text{V}$ , $10\text{ mA} \leq I_{\text{OUT}} \leq 100\text{ mA}$	36	<b>60</b>	45	<b>75</b>	mV mV(max)
$I_{\text{GND}}$	Ground Pin Current	$V_{\text{NOM}} + 1.5\text{V} \leq V_{\text{IN}} \leq 30\text{V}$ , No Load	2	<b>4</b>	2	<b>4</b>	mA mA(max)
$V_{\text{IN}} - V_{\text{OUT}}$	Dropout Voltage	$I_{\text{OUT}} = 10\text{ mA}$	0.7	0.9 <b>1.0</b>	0.7	0.9 <b>1.0</b>	V V(max) V(max)
		$I_{\text{OUT}} = 100\text{ mA}$	0.9	1.1 <b>1.2</b>	0.9	1.1 <b>1.2</b>	V V(max) V(max)
$e_n$	Output Noise Voltage	$V_{\text{IN}} = 10\text{V}$ , Bandwidth: 10 Hz to 100 kHz	360		450		$\mu\text{V}_{\text{rms}}$

**Note 1:** The package code MA03B is internal to National Semiconductor Corporation and indicates a specific version of the SOT-23 package and associated mechanical drawings.

**Note 2:** The suffix "I" indicates the junction temperature range for operation is the industrial temperature range,  $-40$  to  $+125^\circ\text{C}$ . The suffix "M3" indicates the die is packaged in the 3-lead SOT-23 package. The suffix "X" indicates the devices will be supplied in blocks of 3k units as opposed to blocks of 250 units.

**Note 3:** Because the entire part number does not fit on the SOT-23 package, the SOT-23 package is marked with this code instead of the part number.

**Note 4:** Absolute Maximum Ratings are limits beyond which damage to the device may occur. Operating Ratings are conditions under which operation of the device is guaranteed. Operating Ratings do not imply guaranteed performance limits. For guaranteed performance limits and associated test conditions, see the Electrical Characteristics tables.

**Note 5:** The Absolute Maximum power dissipation depends on the ambient temperature and can be calculated using  $P = (T_J - T_A)/\theta_{JA}$  where  $T_J$  is the junction temperature,  $T_A$  is the ambient temperature, and  $\theta_{JA}$  is the junction-to-ambient thermal resistance. The 333 mW rating results from substituting the Absolute Maximum junction temperature,  $150^\circ\text{C}$ , for  $T_J$ ,  $50^\circ\text{C}$  for  $T_A$ , and  $300^\circ\text{C/W}$  for  $\theta_{JA}$ . More power can be safely dissipated at lower ambient temperatures. Less power can be safely dissipated at higher ambient temperatures. The Absolute Maximum power dissipation can be increased by 3.33 mW for each  $^\circ\text{C}$  below  $50^\circ\text{C}$  ambient. It must be derated by 3.33 mW for each  $^\circ\text{C}$  above  $50^\circ\text{C}$  ambient. A  $\theta_{JA}$  of  $300^\circ\text{C/W}$  represents the worst-case condition of no heat sinking of the 3-lead plastic SOT-23 package. Heat sinking enables the safe dissipation of more power. The LM3480 actively limits its junction temperature to about  $150^\circ\text{C}$ .

**Note 6:** Times shown are dwell times. Temperatures shown are dwell temperatures. For detailed information on soldering plastic small-outline packages, refer to the *Packaging Databook* available from National Semiconductor Corporation.

**Note 7:** For testing purposes, ESD was applied using the human-body model, a 100 pF capacitor discharged through a 1.5 k $\Omega$  resistor.

**Note 8:** As with the Absolute Maximum power dissipation, the maximum power dissipation for operation depends on the ambient temperature. The 250 mW rating appearing under Operating Ratings results from substituting the maximum junction temperature for operation,  $125^\circ\text{C}$ , for  $T_J$ ,  $50^\circ\text{C}$  for  $T_A$ , and  $300^\circ\text{C/W}$  for  $\theta_{JA}$  in  $P = (T_J - T_A)/\theta_{JA}$ . More power can be dissipated at lower ambient temperatures. Less power can be dissipated at higher ambient temperatures. The maximum power dissipation for operation appearing under Operating Ratings can be increased by 3.33 mW for each  $^\circ\text{C}$  below  $50^\circ\text{C}$  ambient. It must be derated by 3.33 mW for each  $^\circ\text{C}$  above  $50^\circ\text{C}$  ambient. A  $\theta_{JA}$  of  $300^\circ\text{C/W}$  represents the worst-case condition of no heat sinking of the 3-lead plastic SOT-23 package. Heat sinking enables the dissipation of more power during operation.

**Note 9:** A typical is the center of characterization data taken with  $T_A = T_J = 25^\circ\text{C}$ . Typical values are not guaranteed.

**Note 10:** All limits are guaranteed. All electrical characteristics having room-temperature limits are tested during production with  $T_A = T_J = 25^\circ\text{C}$ . All hot and cold limits are guaranteed by correlating the electrical characteristics to process and temperature variations and applying statistical process control.

**Note 11:** All voltages except dropout are with respect to the voltage at the GND pin.

**Typical Performance Characteristics** Unless indicated otherwise,  $V_{IN} = V_{NOM} + 1.5V$ ,  $C_{IN} = 0.1 \mu F$ ,  $C_{OUT} = 0.1 \mu F$ , and  $T_A = 25^\circ C$ .

**Dropout Voltage vs Load Current**

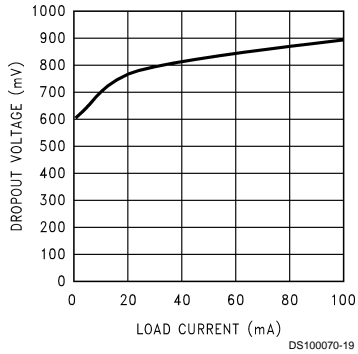

**Dropout Voltage vs Junction Temperature**

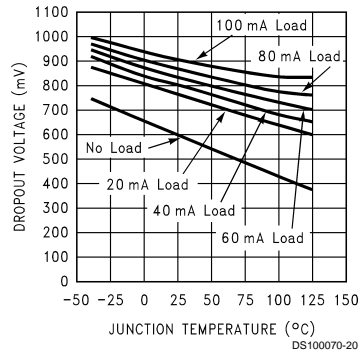

**Ground Pin Current vs Input Voltage**

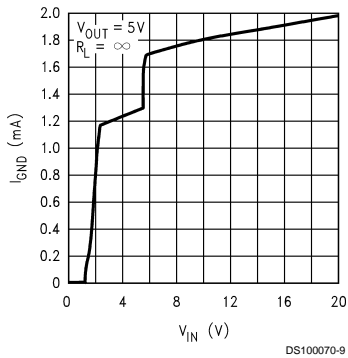

**Ground Pin Current vs Input Voltage**

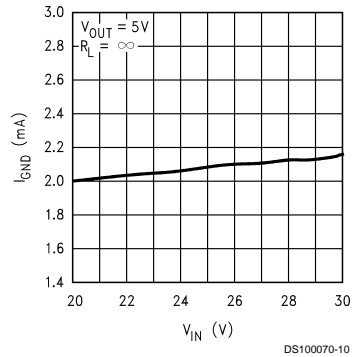

**Ground Pin Current vs Load Current**

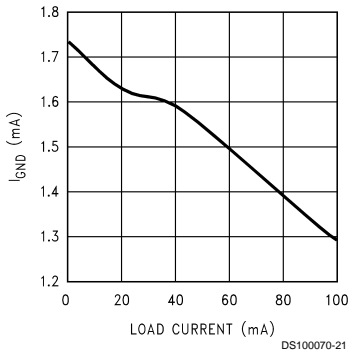

**Ground Pin Current vs Junction Temperature**

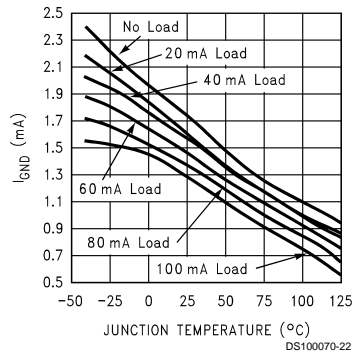

**Typical Performance Characteristics** Unless indicated otherwise,  $V_{IN} = V_{NOM} + 1.5V$ ,  $C_{IN} = 0.1 \mu F$ ,  $C_{OUT} = 0.1 \mu F$ , and  $T_A = 25^\circ C$ . (Continued)

**Input Current vs Input Voltage**

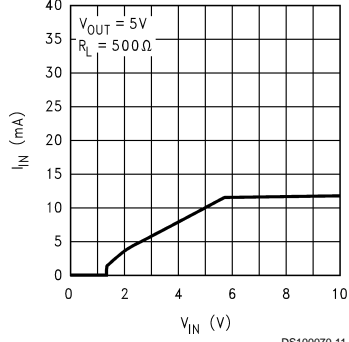

**Input Current vs Input Voltage**

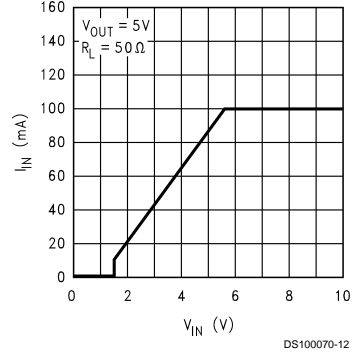

**Line Transient Response**

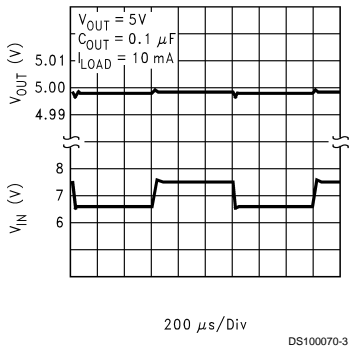

**Line Transient Response**

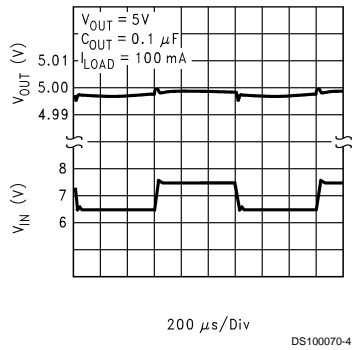

**Load Transient Response**

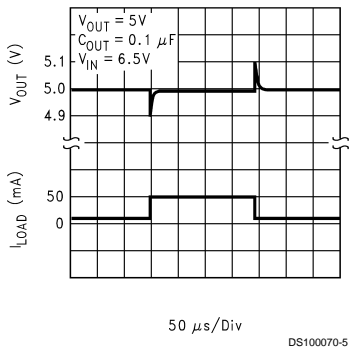

**Load Transient Response**

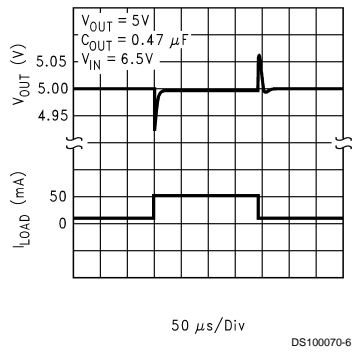

**Typical Performance Characteristics** Unless indicated otherwise,  $V_{IN} = V_{NOM} + 1.5V$ ,  $C_{IN} = 0.1 \mu F$ ,  $C_{OUT} = 0.1 \mu F$ , and  $T_A = 25^\circ C$ . (Continued)

**Load Transient Response**

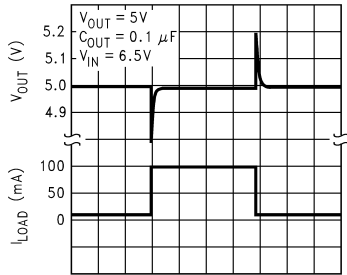

50  $\mu s$ /Div

DS100070-7

**Load Transient Response**

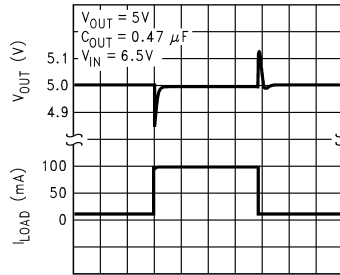

50  $\mu s$ /Div

DS100070-8

**Output Voltage vs Input Voltage**

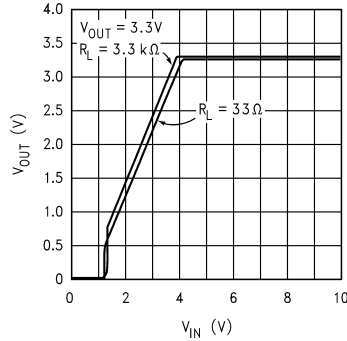

DS100070-13

**Output Voltage vs Input Voltage**

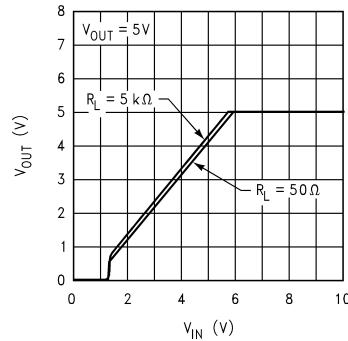

DS100070-14

**Output Voltage vs Input Voltage**

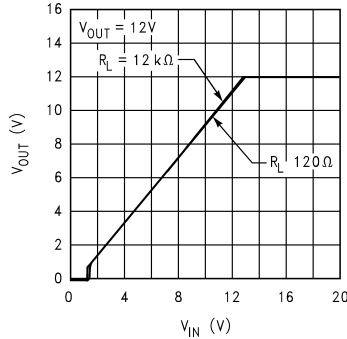

DS100070-15

**Output Voltage vs Input Voltage**

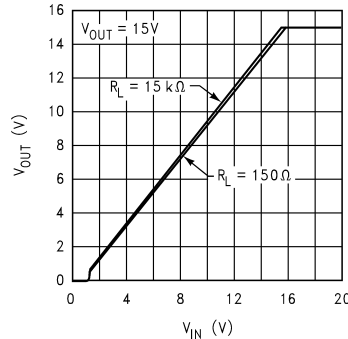

DS100070-16

**Typical Performance Characteristics** Unless indicated otherwise,  $V_{IN} = V_{NOM} + 1.5V$ ,  $C_{IN} = 0.1 \mu F$ ,  $C_{OUT} = 0.1 \mu F$ , and  $T_A = 25^\circ C$ . (Continued)

**Output Short-Circuit Current**

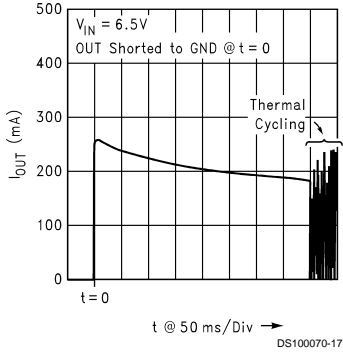

**Output Short-Circuit Current**

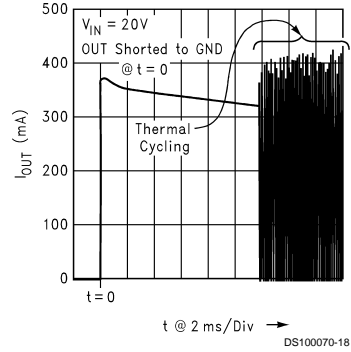

**Power Supply Rejection Ratio**

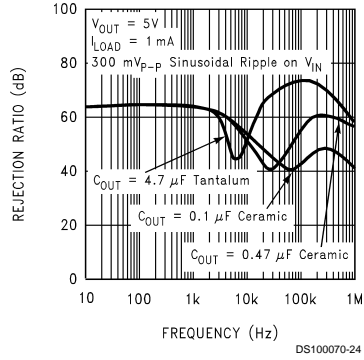

**Power Supply Rejection Ratio**

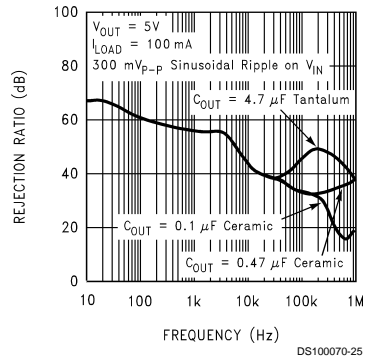

**DC Load Regulation**

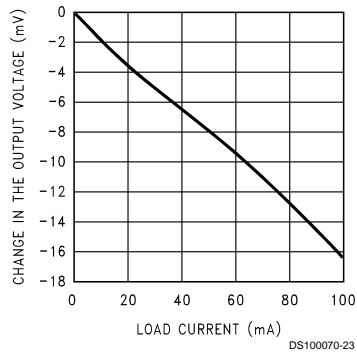



**Physical Dimensions** inches (millimeters) unless otherwise noted

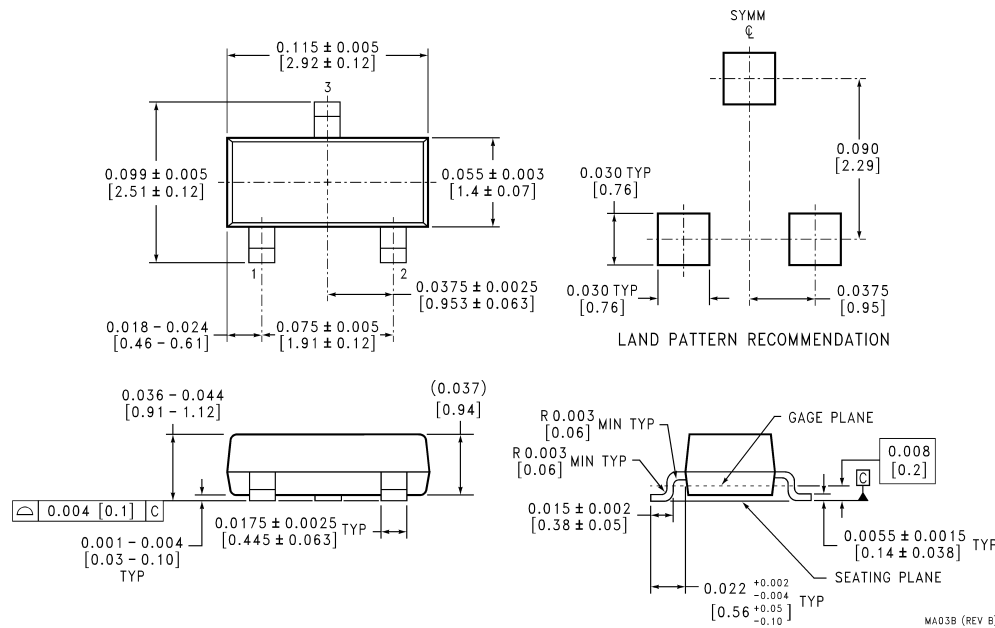

**SOT-23 Package**  
**3-Lead Small-Outline Package (M3)**  
 For Ordering, Refer to Ordering Information Table  
 NS Package Number MA03B

**LIFE SUPPORT POLICY**

NATIONAL'S PRODUCTS ARE NOT AUTHORIZED FOR USE AS CRITICAL COMPONENTS IN LIFE SUPPORT DEVICES OR SYSTEMS WITHOUT THE EXPRESS WRITTEN APPROVAL OF THE PRESIDENT AND GENERAL COUNSEL OF NATIONAL SEMICONDUCTOR CORPORATION. As used herein:

1. Life support devices or systems are devices or systems which, (a) are intended for surgical implant into the body, or (b) support or sustain life, and whose failure to perform when properly used in accordance with instructions for use provided in the labeling, can be reasonably expected to result in a significant injury to the user.
2. A critical component is any component of a life support device or system whose failure to perform can be reasonably expected to cause the failure of the life support device or system, or to affect its safety or effectiveness.

 **National Semiconductor Corporation**  
 Americas  
 Tel: 1-800-272-9959  
 Fax: 1-800-737-7018  
 Email: support@nsc.com

www.national.com

**National Semiconductor Europe**  
 Fax: +49 (0) 1 80-530 85 86  
 Email: europe.support@nsc.com  
 Deutsch Tel: +49 (0) 1 80-530 85 85  
 English Tel: +49 (0) 1 80-532 78 32  
 Français Tel: +49 (0) 1 80-532 93 58  
 Italiano Tel: +49 (0) 1 80-534 16 80

**National Semiconductor Asia Pacific Customer Response Group**  
 Tel: 65-2544466  
 Fax: 65-2504466  
 Email: sea.support@nsc.com

**National Semiconductor Japan Ltd.**  
 Tel: 81-3-5639-7560  
 Fax: 81-3-5639-7507