

## LM4864 Boomer® Audio Power Amplifier Series

### 300 mW Audio Power Amplifier with Shutdown Mode

#### General Description

The LM4864 is a bridged audio power amplifier capable of delivering 300 mW of continuous average power into an 8Ω load with 1% (THD) from a 5V power supply.

Boomer® audio power amplifiers were designed specifically to provide high quality output power from a low supply voltage while requiring a minimal amount of external components. Since the LM4864 does not require output coupling capacitors, bootstrap capacitors or snubber networks, it is optimally suited for low-power portable applications.

The LM4864 features an externally controlled, low power consumption shutdown mode, and thermal shutdown protection.

The closed loop response of the unity-gain stable LM4864, can be configured by external gain-setting resistors. The device is available in multiple package types to suit various applications.

#### Key Specifications

- THD at 1 kHz at 300 mW continuous average output power into 8Ω 1.0% (max)
- THD at 1 kHz at 300 mW continuous average output power into 16Ω 1.0% (max)
- Shutdown current 0.7 μA (typ)

#### Features

- MSOP, SOP, and DIP packaging
- No output coupling capacitors, bootstrap capacitors, or snubber circuits are necessary
- Thermal shutdown protection circuitry
- Unity-gain stable
- External gain configuration capability

#### Applications

- Cellular Phones
- Personal Computers
- General Purpose Audio

#### Typical Application

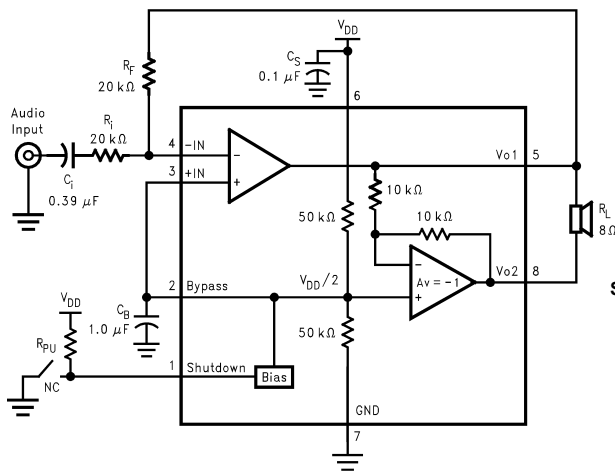
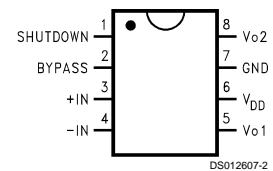

FIGURE 1. Typical Audio Amplifier Application Circuit

#### Connection Diagram

##### MSOP, SOP, and DIP Package



Top View  
Order Number LM4864MM,  
LM4864M or LM4864N  
See NS Package Number MUA08A,  
M08A or N08E

Boomer® is a registered trademark of National Semiconductor Corporation.

## Absolute Maximum Ratings (Note 2)

If Military/Aerospace specified devices are required, please contact the National Semiconductor Sales Office/ Distributors for availability and specifications.

Supply Voltage	6.0V
Storage Temperature	-65°C to +150°C
Input Voltage	-0.3V to $V_{DD} + 0.3V$
Power Dissipation (Note 3)	Internally limited
ESD Susceptibility (Note 4)	3500V
ESD Susceptibility (Note 5)	250V
Junction Temperature	150°C
Soldering Information	
Small Outline Package	
Vapor Phase (60 sec.)	215°C
Infrared (15 sec.)	220°C

See AN-450 "Surface Mounting and their Effects on Product Reliability" for other methods of soldering surface mount devices.

Thermal Resistance

$\theta_{JC}$ (MSOP)	56° C/W
$\theta_{JA}$ (MSOP)	210° C/W
$\theta_{JC}$ (SOP)	35° C/W
$\theta_{JA}$ (SOP)	170° C/W
$\theta_{JC}$ (DIP)	37° C/W
$\theta_{JA}$ (DIP)	107° C/W

## Operating Ratings

Temperature Range

$T_{MIN} \leq T_A \leq T_{MAX}$	-40°C ≤ $T_A$ ≤ +85°C
Supply Voltage	2.7V ≤ $V_{DD}$ ≤ 5.5V

## Electrical Characteristics (Note 1) (Note 2)

The following specifications apply for  $V_{DD} = 5V$ , for all available packages, unless otherwise specified. Limits apply for  $T_A = 25^\circ C$

Symbol	Parameter	Conditions	LM4864		Units (Limits)
			Typical (Note 6)	Limit (Note 7)	
$I_{DD}$	Quiescent Power Supply Current	$V_{IN} = 0V, I_O = 0A$ (Note 8)	3.6	6.0	mA (max)
$I_{SD}$	Shutdown Current	$V_{PIN1} = V_{DD}$	0.7	5	μA (max)
$V_{OS}$	Output Offset Voltage	$V_{IN} = 0V$	5	50	mV (max)
$P_O$	Output Power	THD = 1% (max); $f = 1$ kHz; $R_L = 8\Omega$ ; LM4864MM (Note 9)		300	mW (min)
		THD = 1% (max); $f = 1$ kHz; $R_L = 8\Omega$ ; LM4864M and LM4864N	675	300	mW (min)
		THD+N = 1%; $f = 1$ kHz; $R_L = 16\Omega$ ; LM4864MM, LM4864M and LM4864N	550		mW
THD+N	Total Harmonic Distortion+Noise	$P_O = 300$ mWrms; $A_{VD} = 2$ ; $R_L = 8\Omega$ ; 20 Hz ≤ $f$ ≤ 20 kHz	0.7		%
PSRR	Power Supply Rejection Ratio	$V_{DD} = 4.9V-5.1V$	50		dB

## Electrical Characteristics (Note 1) (Note 2)

The following specifications apply for  $V_{DD} = 3V$ , for all available packages, unless otherwise specified. Limits apply for  $T_A = 25^\circ C$

Symbol	Parameter	Conditions	LM4864		Units (Limits)
			Typical (Note 6)	Limit (Note 7)	
$I_{DD}$	Quiescent Power Supply Current	$V_{IN} = 0V, I_O = 0A$ (Note 8)	1.0	3.0	mA (max)
$I_{SD}$	Shutdown Current	$V_{PIN1} = V_{DD}$	0.3	2.0	μA (max)
$V_{OS}$	Output Offset Voltage	$V_{IN} = 0V$	5		mV
$P_O$	Output Power	THD = 1% (max); $f = 1$ kHz; $R_L = 8\Omega$	200		mW
		THD = 1% (max); $f = 1$ kHz; $R_L = 16\Omega$	175		mW
THD+N	Total Harmonic Distortion+Noise	$P_O = 100$ mWrms; $A_{VD} = 2$ ; $R_L = 8\Omega$ ; 20 Hz ≤ $f$ ≤ 20 kHz, BW < 80 kHz	1.5		%
PSRR	Power Supply Rejection Ratio	$V_{DD} = 2.9V-3.1V$	50		dB

**Note 1:** All voltages are measured with respect to the ground pin, unless otherwise specified.

**Note 2:** Absolute Maximum Ratings indicate limits beyond which damage to the device may occur. Operating Ratings indicate conditions for which the device is functional, but do not guarantee specific performance limits. Electrical Characteristics state DC and AC electrical specifications under particular test conditions which guarantee specific performance limits. This assumes that the device is within the Operating Ratings. Specifications are not guaranteed for parameters where no limit is given, however, the typical value is a good indication of device performance.

## Electrical Characteristics (Note 1) (Note 2) (Continued)

**Note 3:** The maximum power dissipation must be derated at elevated temperatures and is dictated by  $T_{JMAX}$ ,  $\theta_{JA}$ , and the ambient temperature  $T_A$ . The maximum allowable power dissipation is  $P_{DMAX} = (T_{JMAX} - T_A)/\theta_{JA}$  or the number given in the Absolute Maximum Ratings, whichever is lower. For the LM4864,  $T_{JMAX} = 150^\circ\text{C}$ . The typical junction-to-ambient thermal resistance, when board mounted, is  $230^\circ\text{C/W}$  for package number MUA08A,  $170^\circ\text{C/W}$  for package number M08A and is  $107^\circ\text{C/W}$  for package number N08E.

**Note 4:** Human body model, 100 pF discharged through a 1.5 k $\Omega$  resistor.

**Note 5:** Machine Model, 220 pF–240 pF discharged through all pins.

**Note 6:** Typicals are measured at  $25^\circ\text{C}$  and represent the parametric norm.

**Note 7:** Limits are guaranteed to National's AOQL (Average Outgoing Quality Level).

**Note 8:** The quiescent power supply current depends on the offset voltage when a practical load is connected to the amplifier.

**Note 9:** The MUA08BA package is thermally limited to 595 mW of power dissipation at room temperature. Referring to the Power Dissipation vs Output Power graph in the **Typical Performance Characteristics** section, the power dissipation limitation for the package occurs at 300 mW of output power. This package limitation is based on  $25^\circ\text{C}$  ambient temperature and  $\theta_{JA} = 210^\circ\text{C}$ . For higher output power possibilities refer to the **Power Dissipation** Section.

## External Components Description (Figure 1)

Components	Functional Description
1. $R_i$	Inverting input resistance which sets the closed-loop gain in conjunction with $R_F$ . This resistor also forms a high pass filter with $C_i$ at $f_c = 1/(2\pi R_i C_i)$ .
2. $C_i$	Input coupling capacitor which blocks the DC voltage at the amplifier's input terminals. Also creates a highpass filter with $R_i$ at $f_c = 1/(2\pi R_i C_i)$ . Refer to the section, <b>Proper Selection of External Components</b> , for an explanation of how to determine the value of $C_i$ .
3. $R_F$	Feedback resistance which sets the closed-loop gain in conjunction with $R_i$ .
4. $C_S$	Supply bypass capacitor which provides power supply filtering. Refer to the <b>Power Supply Bypassing</b> section for information concerning proper placement and selection of the supply bypass capacitor.
5. $C_B$	Bypass pin capacitor which provides half-supply filtering. Refer to the <b>Proper Selection of External Components</b> for information concerning proper placement and selection of $C_B$ .

## Typical Performance Characteristics

THD+N vs Frequency

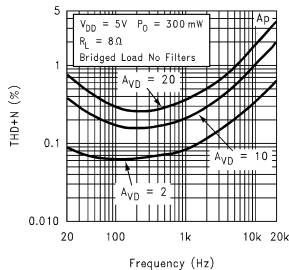

DS012607-3

THD+N vs Frequency

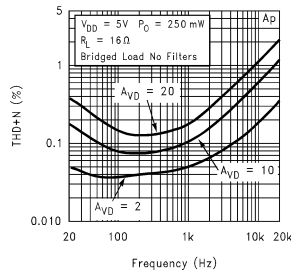

DS012607-4

THD+N vs Frequency

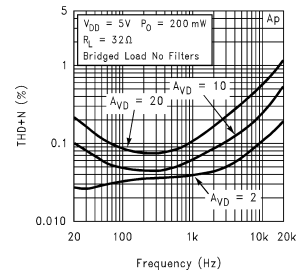

DS012607-5

THD+N vs Frequency

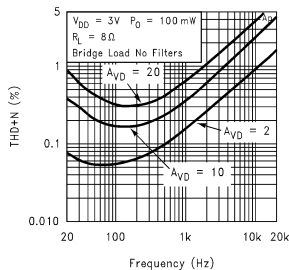

DS012607-6

THD+N vs Frequency

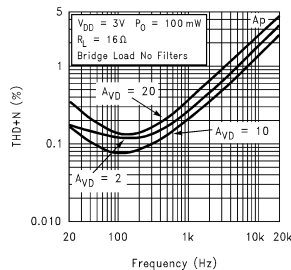

DS012607-7

THD+N vs Frequency

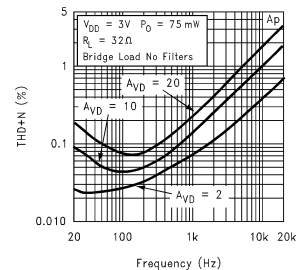

DS012607-8

## Typical Performance Characteristics (Continued)

THD+N vs Output Power

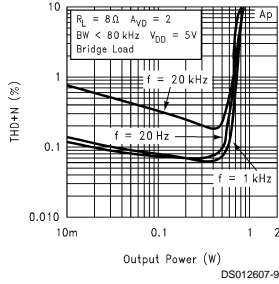

THD+N vs Output Power

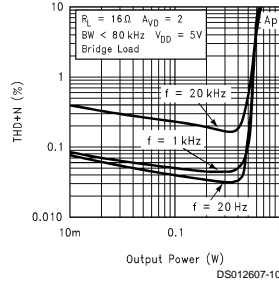

THD+N vs Output Power

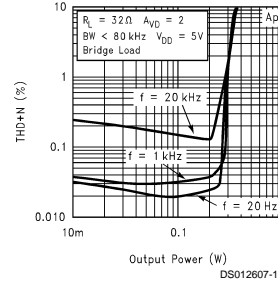

THD+N vs Output Power

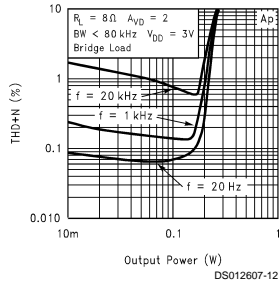

THD+N vs Output Power

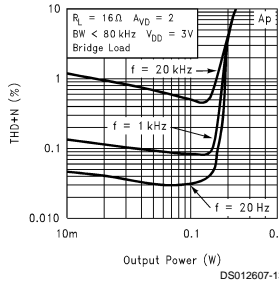

THD+N vs Output Power

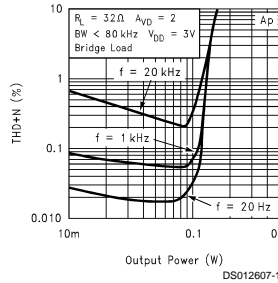

Output Power vs Supply Voltage

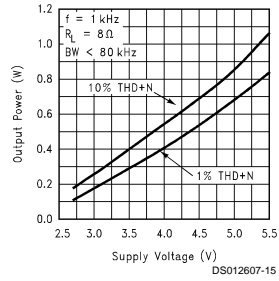

Output Power vs Supply Voltage

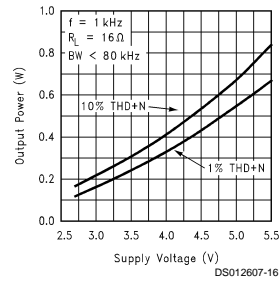

Output Power vs Supply Voltage

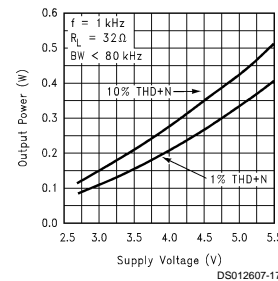

## Typical Performance Characteristics (Continued)

**Output Power vs Load Resistance**

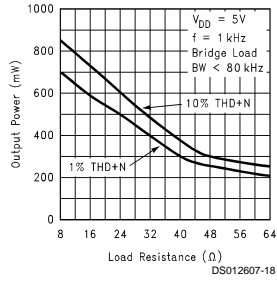

**Power Dissipation vs Output Power**

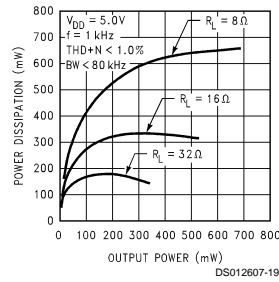

**Power Derating Curve**

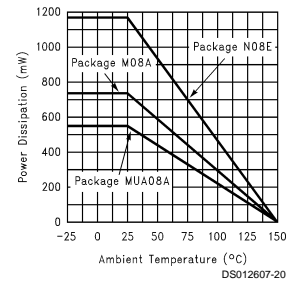

**Dropout Voltage vs Supply Voltage**

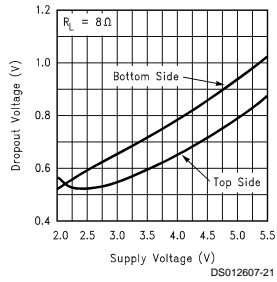

**Noise Floor**

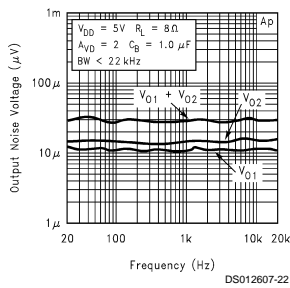

**Frequency Response vs Input Capacitor Size**

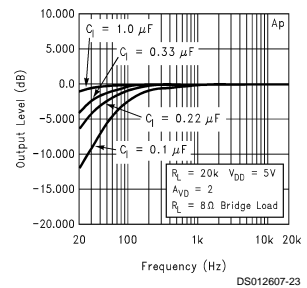

**Power Supply Rejection Ratio**

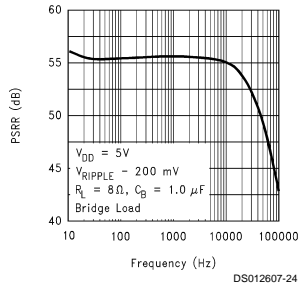

**Open Loop Frequency Response**

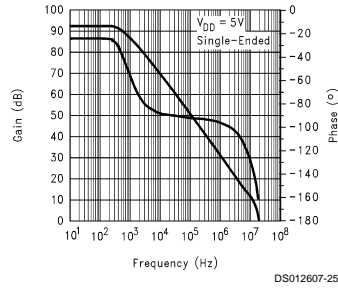

**Supply Current vs Supply Voltage**

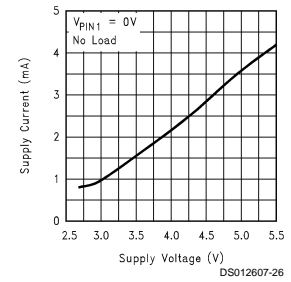

## Application Information

### BRIDGE CONFIGURATION EXPLANATION

As shown in *Figure 1*, the LM4864 has two operational amplifiers internally, allowing for a few different amplifier configurations. The first amplifier's gain is externally configurable, while the second amplifier is internally fixed in a unity-gain, inverting configuration. The closed-loop gain of the first amplifier is set by selecting the ratio of  $R_F$  to  $R_i$  while the second amplifier's gain is fixed by the two internal 10 k $\Omega$  resistors. *Figure 1* shows that the output of amplifier one serves as the input to amplifier two which results in both amplifiers producing signals identical in magnitude, but out of phase 180°. Consequently, the differential gain for the IC is

$$A_{VD} = 2 * (R_F / R_i)$$

By driving the load differentially through outputs  $V_{o1}$  and  $V_{o2}$ , an amplifier configuration commonly referred to as "bridged mode" is established. Bridged mode operation is different from the classical single-ended amplifier configuration where one side of its load is connected to ground.

A bridge amplifier design has a few distinct advantages over the single-ended configuration, as it provides differential drive to the load, thus doubling output swing for a specified supply voltage. Four times the output power is possible as compared to a single-ended amplifier under the same conditions. This increase in attainable output power assumes that the amplifier is not current limited or clipped. In order to choose an amplifier's closed-loop gain without causing excessive clipping, please refer to the **Audio Power Amplifier Design** section.

A bridge configuration, such as the one used in LM4864, also creates a second advantage over single-ended amplifiers. Since the differential outputs,  $V_{o1}$  and  $V_{o2}$ , are biased at half-supply, no net DC voltage exists across the load. This eliminates the need for an output coupling capacitor which is required in a single supply, single-ended amplifier configuration. If an output coupling capacitor is not used in a single-ended configuration, the half-supply bias across the load would result in both increased internal IC power dissipation as well as permanent loudspeaker damage.

### POWER DISSIPATION

Power dissipation is a major concern when designing a successful amplifier, whether the amplifier is bridged or single-ended. Equation 1 states the maximum power dissipation point for a bridge amplifier operating at a given supply voltage and driving a specified output load.

$$P_{DMAX} = (V_{DD})^2 / (2\pi^2 R_L) \quad \text{Single-Ended (1)}$$

However, a direct consequence of the increased power delivered to the load by a bridge amplifier is an increase in internal power dissipation point for a bridge amplifier operating at the same conditions.

$$P_{DMAX} = 4(V_{DD})^2 / (\pi^2 R_L) \quad \text{Bridge Mode (2)}$$

Since the LM4864 has two operational amplifiers in one package, the maximum internal power dissipation is 4 times that of a single-ended amplifier. Even with this substantial increase in power dissipation, the LM4864 does not require heatsinking. From Equation 1, assuming a 5V power supply and an 8 $\Omega$  load, the maximum power dissipation point is 625 mW. The maximum power dissipation point obtained from Equation 2 must not be greater than the power dissipation that results from Equation 3:

$$P_{DMAX} = (T_{JMAX} - T_A) / \theta_{JA} \quad (3)$$

For package MUA08A,  $\theta_{JA} = 210^\circ\text{C/W}$ , for package M08A,  $\theta_{JA} = 170^\circ\text{C/W}$  and for package N08E,  $\theta_{JA} = 107^\circ\text{C/W}$ .  $T_{JMAX} = 150^\circ\text{C}$  for the LM4864. Depending on the ambient temperature,  $T_A$ , of the system surroundings, Equation 3 can be used to find the maximum internal power dissipation supported by the IC packaging. If the result of Equation 2 is greater than that of Equation 3, then either the supply voltage must be decreased, the load impedance increased, the ambient temperature reduced, or the  $\theta_{JA}$  reduced with heat-sinking. In many cases larger traces near the output,  $V_{DD}$ , and Gnd pins can be used to lower the  $\theta_{JA}$ . The larger areas of copper provide a form of heatsinking allowing a higher power dissipation. For the typical application of a 5V power supply, with an 8 $\Omega$  load, the maximum ambient temperature possible without violating the maximum junction temperature is approximately 44°C provided that device operation is around the maximum power dissipation point and assuming surface mount packaging. Internal power dissipation is a function of output power. If typical operation is not around the maximum power dissipation point, the ambient temperature can be increased. Refer to the **Typical Performance Characteristics** curves for power dissipation information for lower output powers.

### POWER SUPPLY BYPASSING

As with any power amplifier, proper supply bypassing is critical for low noise performance and high power supply rejection. The capacitor location on both the bypass and power supply pins should be as close to the device as possible. The effect of a larger half supply bypass capacitor is improved PSRR due to increased half-supply stability. Typical applications employ a 5V regulator with 10  $\mu\text{F}$  and a 0.1  $\mu\text{F}$  bypass capacitors which aid in supply stability, but do not eliminate the need for bypassing the supply nodes of the LM4864. The selection of bypass capacitors, especially  $C_B$ , is thus dependent upon desired PSRR requirements, click and pop performance as explained in the section, **Proper Selection of External Components**, system cost, and size constraints.

### SHUTDOWN FUNCTION

In order to reduce power consumption while not in use, the LM4864 contains a shutdown pin to externally turn off the amplifier's bias circuitry. This shutdown feature turns the amplifier off when a logic high is placed on the shutdown pin. The trigger point between a logic low and logic high level is typically half supply. It is best to switch between ground and supply to provide maximum device performance. By switching the shutdown pin to  $V_{DD}$ , the LM4864 supply current draw will be minimized in idle mode. While the device will be disabled with shutdown pin voltages less than  $V_{DD}$ , the idle current may be greater than the typical value of 0.7  $\mu\text{A}$ . In either case, the shutdown pin should be tied to a definite voltage to avoid unwanted state changes.

In many applications, a microcontroller or microprocessor output is used to control the shutdown circuitry which provides a quick, smooth transition into shutdown. Another solution is to use a single-pole, single-throw switch in conjunction with an external pull-up resistor. When the switch is closed, the shutdown pin is connected to ground and enables the amplifier. If the switch is open, then the external pull-up resistor will disable the LM4864. This scheme guarantees that the shutdown pin will not float, thus preventing unwanted state changes.

## Application Information (Continued)

### PROPER SELECTION OF EXTERNAL COMPONENTS

Proper selection of external components in applications using integrated power amplifiers is critical to optimize device and system performance. While the LM4864 is tolerant to a variety of external component combinations, consideration to component values must be used to maximize overall system quality.

The LM4864 is unity-gain stable, giving a designer maximum system flexibility. The LM4864 should be used in low gain configurations to minimize THD+N values, and maximize the signal to noise ratio. Low gain configurations require large input signals to obtain a given output power. Input signals equal to or greater than 1 V<sub>rms</sub> are available from sources such as audio codecs. Please refer to the section, **Audio Power Amplifier Design**, for a more complete explanation of proper gain selection.

Besides gain, one of the major considerations is the closed-loop bandwidth of the amplifier. To a large extent, the bandwidth is dictated by the choice of external components shown in *Figure 1*. The input coupling capacitor, C<sub>i</sub>, forms a first order high pass filter which limits low frequency response. This value should be chosen based on needed frequency response for a few distinct reasons.

#### Selection of Input Capacitor Size

Large input capacitors are both expensive and space hungry for portable designs. Clearly, a certain sized capacitor is needed to couple in low frequencies without severe attenuation. But in many cases the speakers used in portable systems, whether internal or external, have little ability to reproduce signals below 150 Hz. In this case using a large input capacitor may not increase system performance.

In addition to system cost and size, click and pop performance is effected by the size of the input coupling capacitor, C<sub>i</sub>. A larger input coupling capacitor requires more charge to reach its quiescent DC voltage (nominally ½ V<sub>DD</sub>). This charge comes from the output via the feedback and is apt to create pops upon device enable. Thus, by minimizing the capacitor size based on necessary low frequency response, turn-on pops can be minimized.

Besides minimizing the input capacitor size, careful consideration should be paid to the bypass capacitor value. Bypass capacitor, C<sub>B</sub>, is the most critical component to minimize turn-on pops since it determines how fast the LM4864 turns on. The slower the LM4864's outputs ramp to their quiescent DC voltage (nominally ½ V<sub>DD</sub>), the smaller the turn-on pop. Choosing C<sub>B</sub> equal to 1.0 μF along with a small value of C<sub>i</sub> (in the range of 0.1 μF to 0.39 μF), should produce a clickless and popless shutdown function. While the device will function properly, (no oscillations or motorboating), with C<sub>B</sub> equal to 0.1 μF, the device will be much more susceptible to turn-on clicks and pops. Thus, a value of C<sub>B</sub> equal to 1.0 μF or larger is recommended in all but the most cost sensitive designs.

## AUDIO POWER AMPLIFIER DESIGN

### Design a 300 mW/8Ω Audio Amplifier

Given:

Power Output	300 mWrms
Load Impedance	8Ω
Input Level	1 Vrms
Input Impedance	20 kΩ
Bandwidth	100 Hz–20 kHz ± 0.25 dB

A designer must first determine the minimum supply rail to obtain the specified output power. By extrapolating from the Output Power vs Supply Voltage graphs in the **Typical Performance Characteristics** section, the supply rail can be easily found. A second way to determine the minimum supply rail is to calculate the required V<sub>opeak</sub> using Equation 4 and add the dropout voltage. Using this method, the minimum supply voltage would be (V<sub>opeak</sub> + (2\*V<sub>OD</sub>)), where V<sub>OD</sub> is extrapolated from the Dropout Voltage vs Supply Voltage curve in the **Typical Performance Characteristics** section.

$$V_{opeak} = \sqrt{2R_L P_O} \quad (4)$$

Using the Output Power vs Supply Voltage graph for an 8Ω load, the minimum supply rail is 3.5V. But since 5V is a standard supply voltage in most applications, it is chosen for the supply rail. Extra supply voltage creates headroom that allows the LM4864 to reproduce peaks in excess of 500 mW without producing audible distortion. At this time, the designer must make sure that the power supply choice along with the output impedance does not violate the conditions explained in the **Power Dissipation** section.

Once the power dissipation equations have been addressed, the required differential gain can be determined from Equation 5.

$$A_{VD} \geq \sqrt{(P_O R_L) / (V_{IN})} = V_{orms} / V_{inrms} \quad (5)$$

$$R_F / R_i = A_{VD} / 2 \quad (6)$$

From Equation 5, the minimum A<sub>VD</sub> is 1.55; use A<sub>VD</sub> = 2. Since the desired input impedance was 20 kΩ, and with a A<sub>VD</sub> of 2, a ratio of 1:1 of R<sub>F</sub> to R<sub>i</sub> results in an allocation of R<sub>F</sub> = R<sub>F</sub> = 20 kΩ. The final design step is to address the bandwidth requirements which must be stated as a pair of -3 dB frequency points. Five times away from a pole gives 0.17 dB down from passband response which is better than the required ±0.25 dB specified.

$$f_L = 100 \text{ Hz} / 5 = 20 \text{ Hz}$$

$$f_H = 20 \text{ kHz} \times 5 = 100 \text{ kHz}$$

As stated in the **External Components** section, R<sub>i</sub> in conjunction with C<sub>i</sub> create a highpass filter.

$$C_i \geq \frac{1}{2\pi R_i f_c}$$

$$C_i \geq 1 / (2\pi * 20 \text{ k}\Omega * 20 \text{ Hz}) = 0.397 \mu\text{F}; \text{ use } 0.39 \mu\text{F}$$

The high frequency pole is determined by the product of the desired high frequency pole, f<sub>H</sub>, and the differential gain, A<sub>VD</sub>. With a A<sub>VD</sub> = 2 and f<sub>H</sub> = 100 kHz, the resulting GBWP = 100 kHz which is much smaller than the LM4864 GBWP of 18 MHz. This figure displays that if a designer has a need to design an amplifier with a higher differential gain, the LM4864 can still be used without running into bandwidth problems.



**Physical Dimensions** inches (millimeters) unless otherwise noted

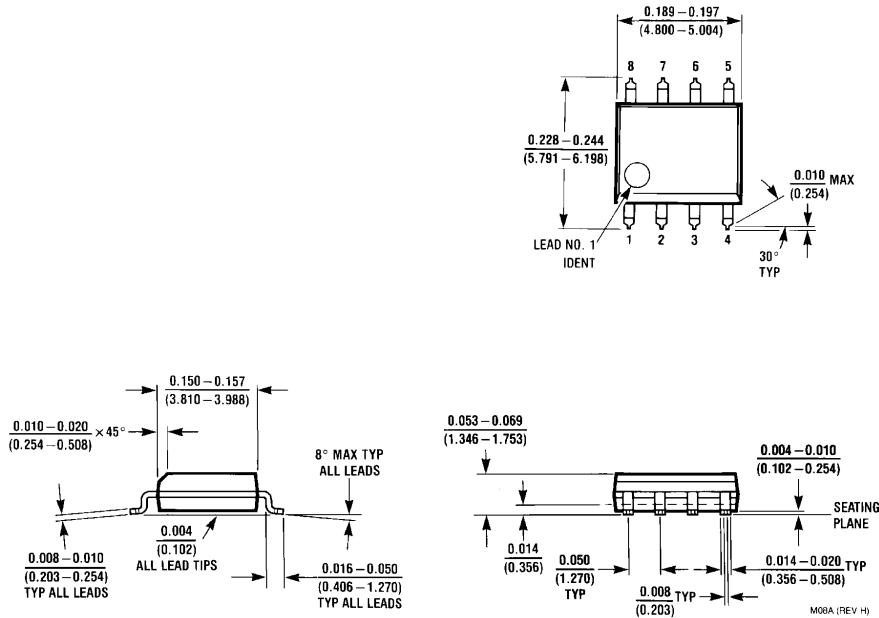

**8-Lead (0.150" Wide) Molded Small Outline Package, JEDEC**  
**Order Number LM4864M**  
**NS Package Number M08A**

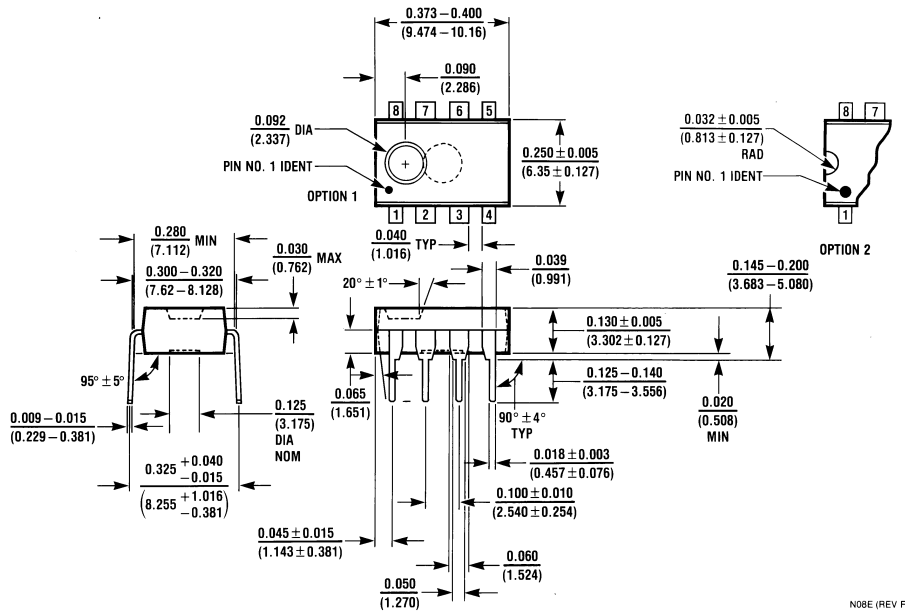

**8-Lead (0.300" Wide) Molded Dual-In-Line Package**  
**Order Number LM4864N**  
**NS Package Number N08E**

**Physical Dimensions** inches (millimeters) unless otherwise noted (Continued)

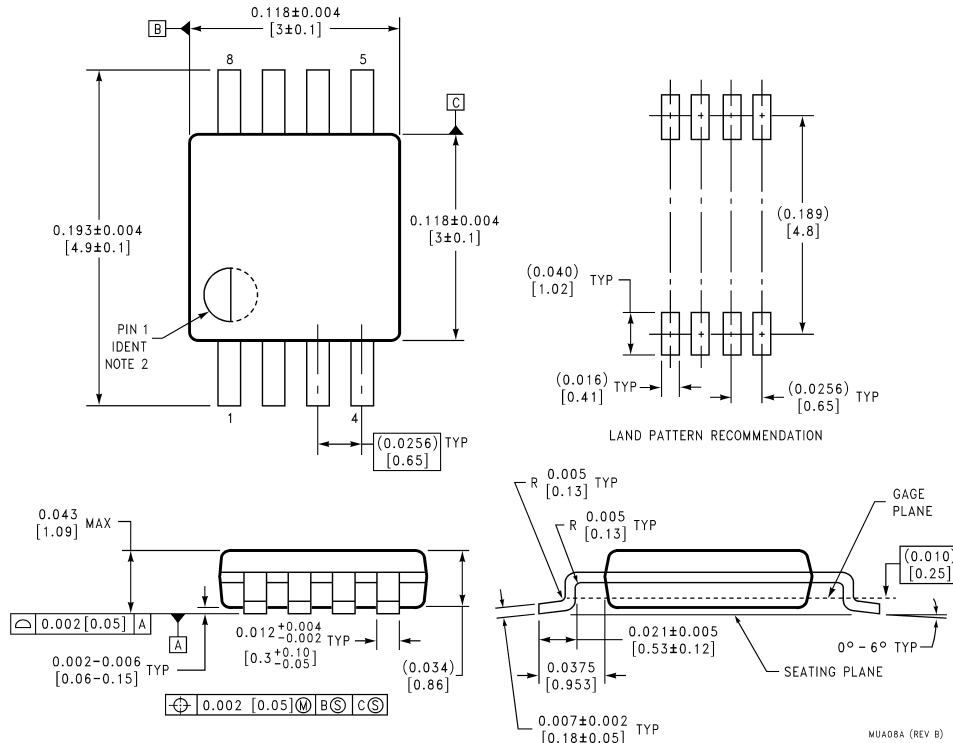

**8-Lead (0.118" Wide) Molded Mini Small Outline Package**  
**Order Number LM4864MM**  
**NS Package Number MUA08A**

**LIFE SUPPORT POLICY**

NATIONAL'S PRODUCTS ARE NOT AUTHORIZED FOR USE AS CRITICAL COMPONENTS IN LIFE SUPPORT DEVICES OR SYSTEMS WITHOUT THE EXPRESS WRITTEN APPROVAL OF THE PRESIDENT AND GENERAL COUNSEL OF NATIONAL SEMICONDUCTOR CORPORATION. As used herein:

1. Life support devices or systems are devices or systems which, (a) are intended for surgical implant into the body, or (b) support or sustain life, and whose failure to perform when properly used in accordance with instructions for use provided in the labeling, can be reasonably expected to result in a significant injury to the user.
2. A critical component is any component of a life support device or system whose failure to perform can be reasonably expected to cause the failure of the life support device or system, or to affect its safety or effectiveness.

 <p><b>National Semiconductor Corporation</b>  Americas  Tel: 1-800-272-9959  Fax: 1-800-737-7018  Email: support@nsc.com</p>	<p><b>National Semiconductor Europe</b>  Fax: +49 (0) 1 80-530 85 86  Email: europe.support@nsc.com  Deutsch Tel: +49 (0) 1 80-530 85 85  English Tel: +49 (0) 1 80-532 78 32  Français Tel: +49 (0) 1 80-532 93 58  Italiano Tel: +49 (0) 1 80-534 16 80</p>	<p><b>National Semiconductor Asia Pacific Customer Response Group</b>  Tel: 65-2544466  Fax: 65-2504466  Email: sea.support@nsc.com</p>	<p><b>National Semiconductor Japan Ltd.</b>  Tel: 81-3-5639-7560  Fax: 81-3-5639-7507</p>
--	---	---	---

National does not assume any responsibility for use of any circuitry described, no circuit patent licenses are implied and National reserves the right at any time without notice to change said circuitry and specifications.