

# LM6171 High Speed Low Power Low Distortion Voltage Feedback Amplifier

## General Description

The LM6171 is a high speed unity-gain stable voltage feedback amplifier. It offers a high slew rate of 3600V/μs and a unity-gain bandwidth of 100 MHz while consuming only 2.5 mA of supply current. The LM6171 has very impressive AC and DC performance which is a great benefit for high speed signal processing and video applications.

The ±15V power supplies allow for large signal swings and give greater dynamic range and signal-to-noise ratio. The LM6171 has high output current drive, low SFDR and THD, ideal for ADC/DAC systems. The LM6171 is specified for ±5V operation for portable applications.

The LM6171 is built on National's advanced VIP™ III (Vertically Integrated PNP) complementary bipolar process.

## Features

(Typical Unless Otherwise Noted)

- Easy-To-Use Voltage Feedback Topology
- Very High Slew Rate: 3600V/μs
- Wide Unity-Gain-Bandwidth Product: 100 MHz
- -3 dB Frequency @  $A_V = +2$ : 62 MHz
- Low Supply Current: 2.5 mA
- High CMRR: 110 dB
- High Open Loop Gain: 90 dB
- Specified for ±15V and ±5V Operation

## Applications

- Multimedia Broadcast Systems
- Line Drivers, Switchers
- Video Amplifiers
- NTSC, PAL® and SECAM Systems
- ADC/DAC Buffers
- HDTV Amplifiers
- Pulse Amplifiers and Peak Detectors
- Instrumentation Amplifier
- Active Filters

## Typical Performance Characteristics

**Closed Loop Frequency Response vs Supply Voltage ( $A_V = +1$ )**

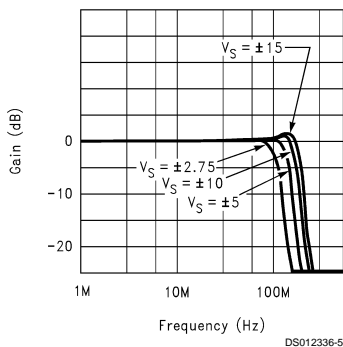

**Large Signal Pulse Response**  
 $A_V = +1, V_S = \pm 15$

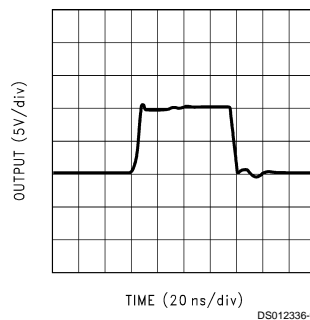

VIP™ is a trademark of National Semiconductor Corporation.  
PAL® is a registered trademark of and used under licence from Advanced Micro Devices, Inc.

## Connection Diagram

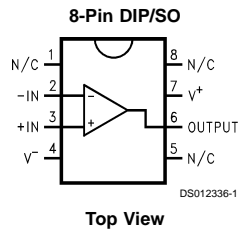

## Ordering Information

| Package                | Temperature Range                              | Transport Media        | NSC Drawing |
|------------------------|--|------------------------|-------------|
|                        | Industrial<br>-40°C to +85°C                   |                        |             |
| 8-Pin<br>Molded DIP    | LM6171AIN<br>LM6171BIN                         | Rails                  | N08E        |
| 8-Pin<br>Small Outline | LM6171AIM, LM6171BIM<br>LM6171AIMX, LM6171BIMX | Rails<br>Tape and Reel | M08A        |

### Absolute Maximum Ratings (Note 1)

If Military/Aerospace specified devices are required, please contact the National Semiconductor Sales Office/Distributors for availability and specifications.

|   |                              |
|---|------------------------------|
| ESD Tolerance (Note 2)                  | 2.5 kV                       |
| Supply Voltage ( $V^+ - V^-$ )          | 36V                          |
| Differential Input Voltage (Note 11)    | $\pm 10V$                    |
| Common-Mode Voltage Range               | $V^+ - 1.4V$ to $V^- + 1.4V$ |
| Output Short Circuit to Ground (Note 3) | Continuous                   |

|                                       |   |
|---------------------------------------|---|
| Storage Temperature Range             | $-65^\circ\text{C}$ to $+150^\circ\text{C}$ |
| Maximum Junction Temperature (Note 4) | $150^\circ\text{C}$                         |

### Operating Ratings (Note 1)

|   |   |
|---|---|
| Supply Voltage                                | $2.75V \leq V^+ \leq 18V$                           |
| Junction Temperature Range LM6171AI, LM6171BI | $-40^\circ\text{C} \leq T_J \leq +85^\circ\text{C}$ |
| Thermal Resistance ( $\theta_{JA}$ )          |   |
| N Package, 8-Pin Molded DIP                   | $108^\circ\text{C/W}$                               |
| M Package, 8-Pin Surface Mount                | $172^\circ\text{C/W}$                               |

### $\pm 15V$ DC Electrical Characteristics

Unless otherwise specified, all limits guaranteed for  $T_J = 25^\circ\text{C}$ ,  $V^+ = +15V$ ,  $V^- = -15V$ ,  $V_{CM} = 0V$ , and  $R_L = 1\text{ k}\Omega$ . **Boldface** limits apply at the temperature extremes

| Symbol      | Parameter                                      | Conditions                  | Typ (Note 5) | LM6171AI Limit (Note 6) | LM6171BI Limit (Note 6) | Units                        |
|-------------|--|-----------------------------|--------------|-------------------------|-------------------------|------------------------------|
| $V_{OS}$    | Input Offset Voltage                           |                             | 1.5          | 3                       | 6                       | mV                           |
|             |  |                             |              | <b>5</b>                | <b>8</b>                | max                          |
| TC $V_{OS}$ | Input Offset Voltage Average Drift             |                             | 6            |                         |                         | $\mu\text{V}/^\circ\text{C}$ |
| $I_B$       | Input Bias Current                             |                             | 1            | 3                       | 3                       | $\mu\text{A}$                |
|             |  |                             |              | <b>4</b>                | <b>4</b>                | max                          |
| $I_{OS}$    | Input Offset Current                           |                             | 0.03         | 2                       | 2                       | $\mu\text{A}$                |
|             |  |                             |              | <b>3</b>                | <b>3</b>                | max                          |
| $R_{IN}$    | Input Resistance                               | Common Mode                 | 40           |                         |                         | M $\Omega$                   |
|             |  | Differential Mode           | 4.9          |                         |                         |                              |
| $R_O$       | Open Loop Output Resistance                    |                             | 14           |                         |                         | $\Omega$                     |
| CMRR        | Common Mode Rejection Ratio                    | $V_{CM} = \pm 10V$          | 110          | 80                      | 75                      | dB                           |
|             |  |                             |              | <b>75</b>               | <b>70</b>               |                              |
| PSRR        | Power Supply Rejection Ratio                   | $V_S = \pm 15V$ to $\pm 5V$ | 95           | 85                      | 80                      | dB                           |
|             |  |                             |              | <b>80</b>               | <b>75</b>               |                              |
| $V_{CM}$    | Input Common-Mode Voltage Range                | CMRR $\geq 60\text{ dB}$    | $\pm 13.5$   |                         |                         | V                            |
| $A_V$       | Large Signal Voltage Gain (Note 7)             | $R_L = 1\text{ k}\Omega$    | 90           | 80                      | 80                      | dB                           |
|             |  |                             |              | <b>70</b>               | <b>70</b>               |                              |
|             |  | $R_L = 100\Omega$           | 83           | 70                      | 70                      | dB                           |
|             |  | <b>60</b>                   | <b>60</b>    | min                     |                         |                              |
| $V_O$       | Output Swing                                   | $R_L = 1\text{ k}\Omega$    | 13.3         | 12.5                    | 12.5                    | V                            |
|             |  |                             |              | <b>12</b>               | <b>12</b>               |                              |
|             |  |                             | -13.3        | -12.5                   | -12.5                   | V                            |
|             |  |                             | <b>-12</b>   | <b>-12</b>              | max                     |                              |
|             |  | $R_L = 100\Omega$           | 11.6         | 9                       | 9                       | V                            |
|             |  |                             |              | <b>8.5</b>              | <b>8.5</b>              |                              |
| -10.5       | -9   |                             | -9           | V                       |                         |                              |
|             | <b>-8.5</b>                                    | <b>-8.5</b>                 | max          |                         |                         |                              |
|             | Continuous Output Current (Open Loop) (Note 8) | Sourcing, $R_L = 100\Omega$ | 116          | 90                      | 90                      | mA                           |
|             |  |                             |              | <b>85</b>               | <b>85</b>               |                              |
|             |  | Sinking, $R_L = 100\Omega$  | 105          | 90                      | 90                      | mA                           |
|             |  | <b>85</b>                   | <b>85</b>    | max                     |                         |                              |

### ±15V DC Electrical Characteristics (Continued)

Unless otherwise specified, all limits guaranteed for  $T_J = 25^\circ\text{C}$ ,  $V^+ = +15\text{V}$ ,  $V^- = -15\text{V}$ ,  $V_{\text{CM}} = 0\text{V}$ , and  $R_L = 1\text{ k}\Omega$ . **Boldface** limits apply at the temperature extremes

| Symbol          | Parameter                                       | Conditions                 | Typ<br>(Note 5) | LM6171AI<br>Limit<br>(Note 6) | LM6171BI<br>Limit<br>(Note 6) | Units |
|-----------------|---|----------------------------|-----------------|-------------------------------|-------------------------------|-------|
|                 | Continuous Output Current<br>(in Linear Region) | Sourcing, $R_L = 10\Omega$ | 100             |                               |                               | mA    |
|                 |   | Sinking, $R_L = 10\Omega$  | 80              |                               |                               | mA    |
| $I_{\text{SC}}$ | Output Short<br>Circuit Current                 | Sourcing                   | 135             |                               |                               | mA    |
|                 |   | Sinking                    | 135             |                               |                               | mA    |
| $I_S$           | Supply Current                                  |                            | 2.5             | 4                             | 4                             | mA    |
|                 |   |                            |                 | <b>4.5</b>                    | <b>4.5</b>                    | max   |

### ±15V AC Electrical Characteristics

Unless otherwise specified, all limits guaranteed for  $T_J = 25^\circ\text{C}$ ,  $V^+ = +15\text{V}$ ,  $V^- = -15\text{V}$ ,  $V_{\text{CM}} = 0\text{V}$ , and  $R_L = 1\text{ k}\Omega$ . **Boldface** limits apply at the temperature extremes

| Symbol   | Parameter                       | Conditions   | Typ<br>(Note 5)   | LM6171AI<br>Limit<br>(Note 6) | LM6171BI<br>Limit<br>(Note 6) | Units                                |
|----------|---------------------------------|--|---|-------------------------------|-------------------------------|--------------------------------------|
| SR       | Slew Rate (Note 9)              | $A_V = +2$ , $V_{\text{IN}} = 13 V_{\text{PP}}$                    | 3600  |                               |                               | V/ $\mu\text{s}$                     |
|          |                                 | $A_V = +2$ , $V_{\text{IN}} = 10 V_{\text{PP}}$                    | 3000  |                               |                               |                                      |
| GBW      | Unity Gain-Bandwidth Product    |  | 100   |                               |                               | MHz                                  |
|          | -3 dB Frequency                 | $A_V = +1$   | 160   |                               |                               | MHz                                  |
|          |                                 | $A_V = +2$   | 62  |                               |                               | MHz                                  |
| $\phi_m$ | Phase Margin                    |  | 40  |                               |                               | deg                                  |
| $t_s$    | Settling Time (0.1%)            | $A_V = -1$ , $V_{\text{OUT}} = \pm 5\text{V}$<br>$R_L = 500\Omega$ | 48  |                               |                               | ns                                   |
|          |                                 | Propagation Delay  | $V_{\text{IN}} = \pm 5\text{V}$ , $R_L = 500\Omega$ ,<br>$A_V = -2$ | 6                             |                               |                                      |
| $A_D$    | Differential Gain (Note 10)     |  | 0.03  |                               |                               | %                                    |
| $\phi_D$ | Differential Phase (Note 10)    |  | 0.5   |                               |                               | deg                                  |
| $e_n$    | Input-Referred<br>Voltage Noise | $f = 1\text{ kHz}$   | 12  |                               |                               | $\frac{\text{nV}}{\sqrt{\text{Hz}}}$ |
| $i_n$    | Input-Referred<br>Current Noise | $f = 1\text{ kHz}$   | 1   |                               |                               | $\frac{\text{pA}}{\sqrt{\text{Hz}}}$ |

### ±5V DC Electrical Characteristics

Unless otherwise specified, all limits guaranteed for  $T_J = 25^\circ\text{C}$ ,  $V^+ = +5\text{V}$ ,  $V^- = -5\text{V}$ ,  $V_{\text{CM}} = 0\text{V}$ , and  $R_L = 1\text{ k}\Omega$ . **Boldface** limits apply at the temperature extremes

| Symbol             | Parameter                             | Conditions | Typ<br>(Note 5) | LM6171AI<br>Limit<br>(Note 6) | LM6171BI<br>Limit<br>(Note 6) | Units                        |
|--------------------|---------------------------------------|------------|-----------------|-------------------------------|-------------------------------|------------------------------|
| $V_{\text{OS}}$    | Input Offset Voltage                  |            | 1.2             | 3                             | 6                             | mV                           |
|                    |                                       |            |                 | <b>5</b>                      | <b>8</b>                      | max                          |
| TC $V_{\text{OS}}$ | Input Offset Voltage<br>Average Drift |            | 4               |                               |                               | $\mu\text{V}/^\circ\text{C}$ |
| $I_B$              | Input Bias Current                    |            | 1               | 2.5                           | 2.5                           | $\mu\text{A}$                |
|                    |                                       |            |                 | <b>3.5</b>                    | <b>3.5</b>                    | max                          |
| $I_{\text{OS}}$    | Input Offset Current                  |            | 0.03            | 1.5                           | 1.5                           | $\mu\text{A}$                |
|                    |                                       |            |                 | <b>2.2</b>                    | <b>2.2</b>                    | max                          |

### ±5V DC Electrical Characteristics (Continued)

Unless otherwise specified, all limits guaranteed for  $T_J = 25^\circ\text{C}$ ,  $V^+ = +5\text{V}$ ,  $V^- = -5\text{V}$ ,  $V_{CM} = 0\text{V}$ , and  $R_L = 1\text{ k}\Omega$ . **Boldface** limits apply at the temperature extremes

| Symbol   | Parameter                                      | Conditions                               | Typ<br>(Note 5) | LM6171AI<br>Limit<br>(Note 6) | LM6171BI<br>Limit<br>(Note 6) | Units     |
|----------|--|--|-----------------|-------------------------------|-------------------------------|-----------|
| $R_{IN}$ | Input Resistance                               | Common Mode                              | 40              |                               |                               | $M\Omega$ |
|          |  | Differential Mode                        | 4.9             |                               |                               |           |
| $R_O$    | Open Loop Output Resistance                    |  | 14              |                               |                               | $\Omega$  |
| CMRR     | Common Mode Rejection Ratio                    | $V_{CM} = \pm 2.5\text{V}$               | 105             | 80<br><b>75</b>               | 75<br><b>70</b>               | dB<br>min |
| PSRR     | Power Supply Rejection Ratio                   | $V_S = \pm 15\text{V to } \pm 5\text{V}$ | 95              | 85<br><b>80</b>               | 80<br><b>75</b>               | dB<br>min |
| $V_{CM}$ | Input Common-Mode Voltage Range                | CMRR $\geq 60\text{ dB}$                 | $\pm 3.7$       |                               |                               | V         |
| $A_V$    | Large Signal Voltage Gain (Note 7)             | $R_L = 1\text{ k}\Omega$                 | 84              | 75<br><b>65</b>               | 75<br><b>65</b>               | dB<br>min |
|          |  | $R_L = 100\Omega$                        | 80              | 70<br><b>60</b>               | 70<br><b>60</b>               | dB<br>min |
| $V_O$    | Output Swing                                   | $R_L = 1\text{ k}\Omega$                 | 3.5             | 3.2<br><b>3</b>               | 3.2<br><b>3</b>               | V<br>min  |
|          |  |  | -3.4            | -3.2<br><b>-3</b>             | -3.2<br><b>-3</b>             | V<br>max  |
|          |  | $R_L = 100\Omega$                        | 3.2             | 2.8<br><b>2.5</b>             | 2.8<br><b>2.5</b>             | V<br>min  |
|          |  |  | -3.0            | -2.8<br><b>-2.5</b>           | -2.8<br><b>-2.5</b>           | V<br>max  |
|          | Continuous Output Current (Open Loop) (Note 8) | Sourcing, $R_L = 100\Omega$              | 32              | 28<br><b>25</b>               | 28<br><b>25</b>               | mA<br>min |
|          |  | Sinking, $R_L = 100\Omega$               | 30              | 28<br><b>25</b>               | 28<br><b>25</b>               | mA<br>max |
| $I_{SC}$ | Output Short Circuit Current                   | Sourcing                                 | 130             |                               |                               | mA        |
|          |  | Sinking                                  | 100             |                               |                               | mA        |
| $I_S$    | Supply Current                                 |  | 2.3             | 3<br><b>3.5</b>               | 3<br><b>3.5</b>               | mA<br>max |

### ±5V AC Electrical Characteristics

Unless otherwise specified, all limits guaranteed for  $T_J = 25^\circ\text{C}$ ,  $V^+ = +5\text{V}$ ,  $V^- = -5\text{V}$ ,  $V_{CM} = 0\text{V}$ , and  $R_L = 1\text{ k}\Omega$ . **Boldface** limits apply at the temperature extremes

| Symbol   | Parameter                    | Conditions   | Typ<br>(Note 5) | LM6171AI<br>Limit<br>(Note 6) | LM6171BI<br>Limit<br>(Note 6) | Units            |
|----------|------------------------------|--|-----------------|-------------------------------|-------------------------------|------------------|
| SR       | Slew Rate (Note 9)           | $A_V = +2$ , $V_{IN} = 3.5 V_{PP}$                         | 750             |                               |                               | V/ $\mu\text{s}$ |
| GBW      | Unity Gain-Bandwidth Product |  | 70              |                               |                               | MHz              |
|          |                              | $A_V = +1$   | 130             |                               |                               |                  |
|          |                              | $A_V = +2$   | 45              |                               |                               | MHz              |
| $\phi_m$ | Phase Margin                 |  | 57              |                               |                               | deg              |
| $t_s$    | Settling Time (0.1%)         | $A_V = -1$ , $V_{OUT} = +1\text{V}$ ,<br>$R_L = 500\Omega$ | 60              |                               |                               | ns               |
|          | Propagation Delay            | $V_{IN} = \pm 1\text{V}$ , $R_L = 500\Omega$               | 8               |                               |                               | ns               |

## ±5V AC Electrical Characteristics (Continued)

Unless otherwise specified, all limits guaranteed for  $T_J = 25^\circ\text{C}$ ,  $V^+ = +5\text{V}$ ,  $V^- = -5\text{V}$ ,  $V_{\text{CM}} = 0\text{V}$ , and  $R_L = 1\text{ k}\Omega$ . **Boldface** limits apply at the temperature extremes

| Symbol   | Parameter                    | Conditions         | Typ (Note 5) | LM6171AI Limit (Note 6) | LM6171BI Limit (Note 6) | Units                                |
|----------|------------------------------|--------------------|--------------|-------------------------|-------------------------|--------------------------------------|
|          |                              | $A_V = -2$         |              |                         |                         |                                      |
| $A_D$    | Differential Gain (Note 10)  |                    | 0.04         |                         |                         | %                                    |
| $\phi_D$ | Differential Phase (Note 10) |                    | 0.7          |                         |                         | deg                                  |
| $e_n$    | Input-Referred Voltage Noise | $f = 1\text{ kHz}$ | 11           |                         |                         | $\frac{\text{nV}}{\sqrt{\text{Hz}}}$ |
| $i_n$    | Input-Referred Current Noise | $f = 1\text{ kHz}$ | 1            |                         |                         | $\frac{\text{pA}}{\sqrt{\text{Hz}}}$ |

**Note 1:** Absolute Maximum Ratings indicate limits beyond which damage to the device may occur. Operating Ratings indicate conditions for which the device is intended to be functional, but specific performance is not guaranteed. For guaranteed specifications and the test conditions, see the Electrical Characteristics.

**Note 2:** Human body model, 1.5 k $\Omega$  in series with 100 pF.

**Note 3:** Continuous short circuit operation at elevated ambient temperature can result in exceeding the maximum allowed junction temperature of 150°C.

**Note 4:** The maximum power dissipation is a function of  $T_{J(\text{max})}$ ,  $\theta_{JA}$ , and  $T_A$ . The maximum allowable power dissipation at any ambient temperature is  $P_D = (T_{J(\text{max})} - T_A)/\theta_{JA}$ . All numbers apply for packages soldered directly into a PC board.

**Note 5:** Typical Values represent the most likely parametric norm.

**Note 6:** All limits are guaranteed by testing or statistical analysis.

**Note 7:** Large signal voltage gain is the total output swing divided by the input signal required to produce that swing. For  $V_S = \pm 15\text{V}$ ,  $V_{\text{OUT}} = \pm 5\text{V}$ . For  $V_S = +5\text{V}$ ,  $V_{\text{OUT}} = \pm 1\text{V}$ .

**Note 8:** The open loop output current is the output swing with the 100 $\Omega$  load resistor divided by that resistor.

**Note 9:** Slew rate is the average of the rising and falling slew rates.

**Note 10:** Differential gain and phase are measured with  $A_V = +2$ ,  $V_{\text{IN}} = 1\text{ V}_{\text{PP}}$  at 3.58 MHz and both input and output 75 $\Omega$  terminated.

**Note 11:** Differential input voltage is measured at  $V_S = \pm 15\text{V}$ .

## Typical Performance Characteristics Unless otherwise noted, $T_A = 25^\circ\text{C}$

**Supply Current vs Supply Voltage**

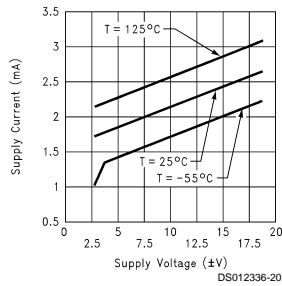

**Supply Current vs Temperature**

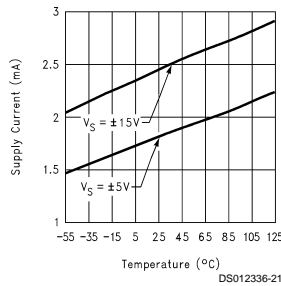

**Input Offset Voltage vs Temperature**

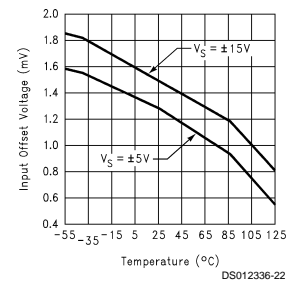

**Input Bias Current vs Temperature**

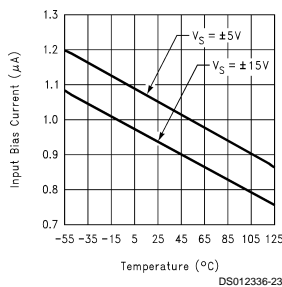

**Input Offset Voltage vs Common Mode Voltage**

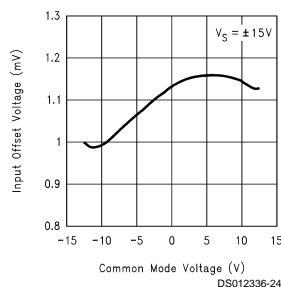

**Short Circuit Current vs Temperature (Sourcing)**

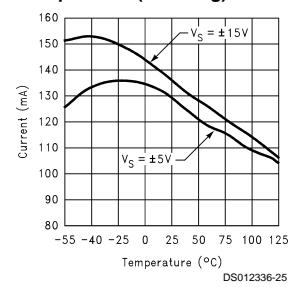

**Typical Performance Characteristics** Unless otherwise noted,  $T_A = 25^\circ\text{C}$  (Continued)

**Short Circuit Current vs Temperature (Sinking)**

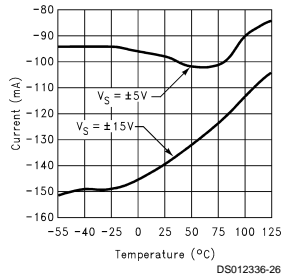

**Output Voltage vs Output Current**

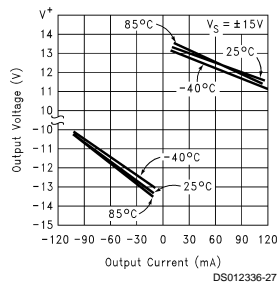

**Output Voltage vs Output Current**

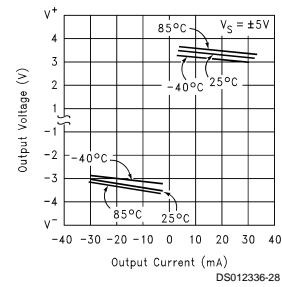

**CMRR vs Frequency**

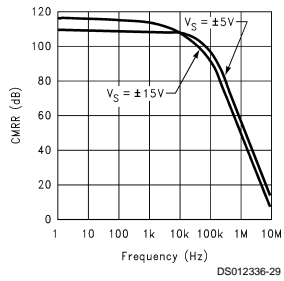

**PSRR vs Frequency**

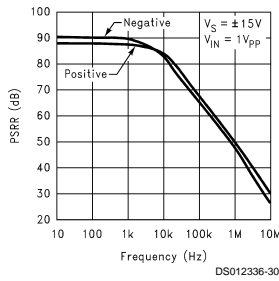

**PSRR vs Frequency**

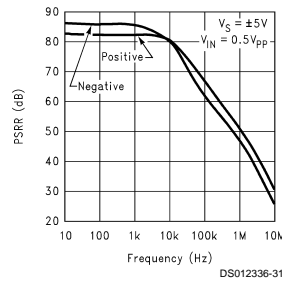

**Open Loop Frequency Response**

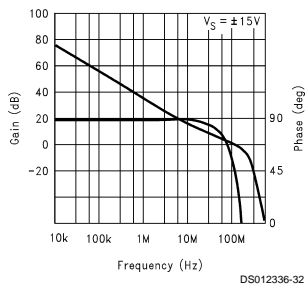

**Open Loop Frequency Response**

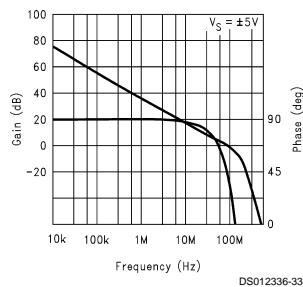

**Gain Bandwidth Product vs Supply Voltage**

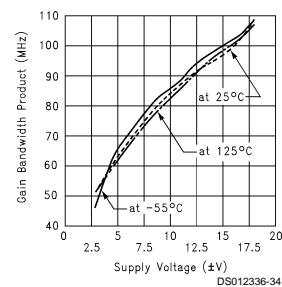

**Typical Performance Characteristics** Unless otherwise noted,  $T_A = 25^\circ\text{C}$  (Continued)

**Gain Bandwidth Product vs Load Capacitance**

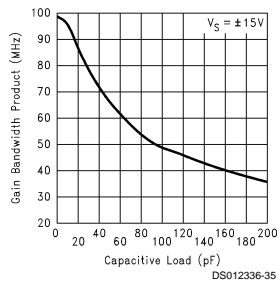

**Large Signal Voltage Gain vs Load**

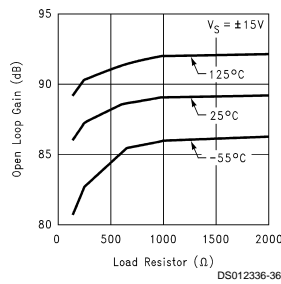

**Large Signal Voltage Gain vs Load**

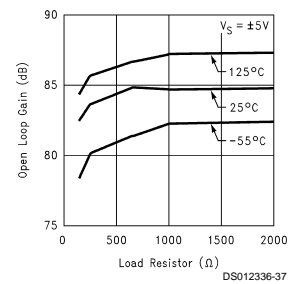

**Input Voltage Noise vs Frequency**

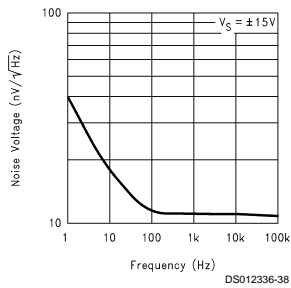

**Input Voltage Noise vs Frequency**

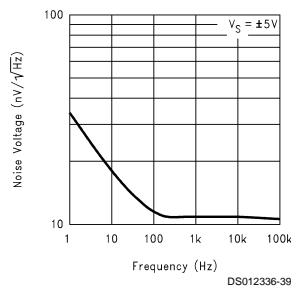

**Input Current Noise vs Frequency**

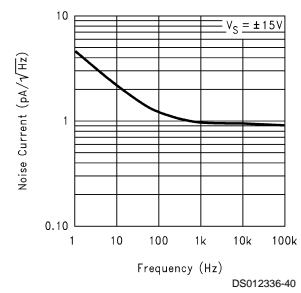

**Input Current Noise vs Frequency**

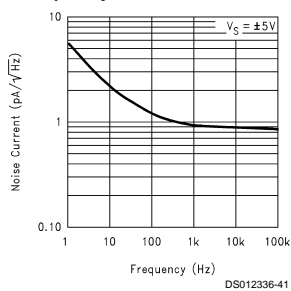

**Slew Rate vs Supply Voltage**

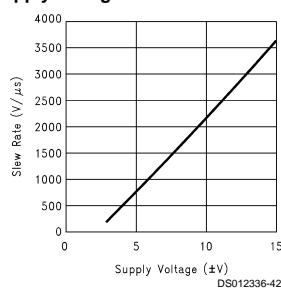

**Slew Rate vs Input Voltage**

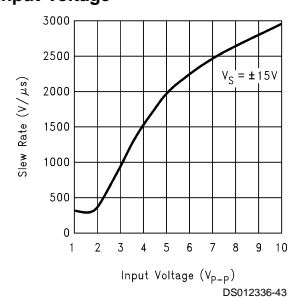



**Typical Performance Characteristics** Unless otherwise noted,  $T_A = 25^\circ\text{C}$  (Continued)

**Slew Rate vs Load Capacitance**

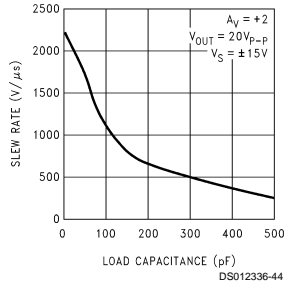

**Open Loop Output Impedance vs Frequency**

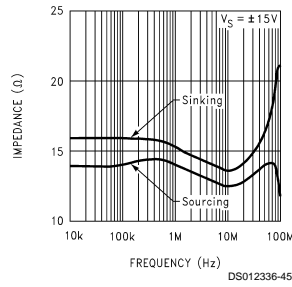

**Open Loop Output Impedance vs Frequency**

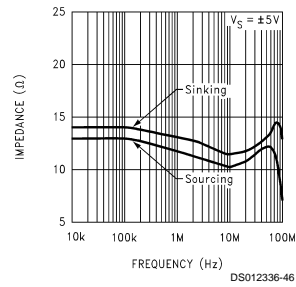

**Large Signal Pulse Response**  
 $A_V = -1, V_S = \pm 15V$

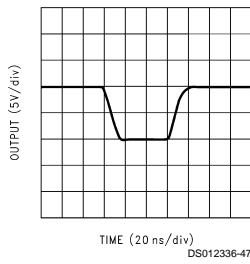

**Large Signal Pulse Response**  
 $A_V = -1, V_S = \pm 5V$

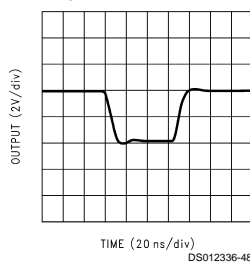

**Large Signal Pulse Response**  
 $A_V = +1, V_S = \pm 15V$

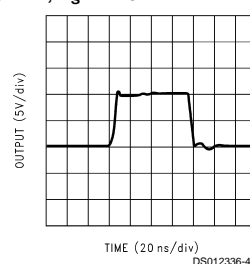

**Large Signal Pulse Response**  
 $A_V = +1, V_S = \pm 5V$

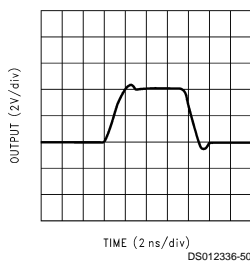

**Large Signal Pulse Response**  
 $A_V = +2, V_S = \pm 15V$

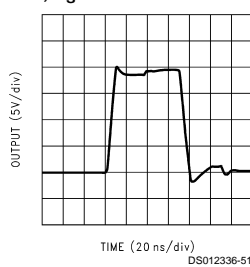

**Large Signal Pulse Response**  
 $A_V = +2, V_S = \pm 5V$

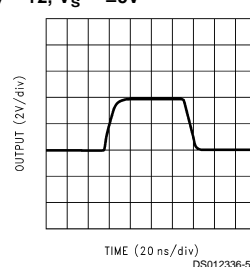

**Typical Performance Characteristics** Unless otherwise noted,  $T_A = 25^\circ\text{C}$  (Continued)

**Small Signal Pulse Response**  
 $A_V = -1, V_S = \pm 15\text{V}$

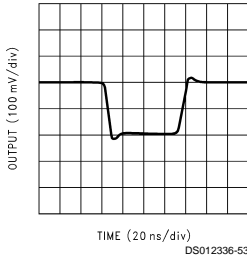

**Small Signal Pulse Response**  
 $A_V = -1, V_S = \pm 5\text{V}$

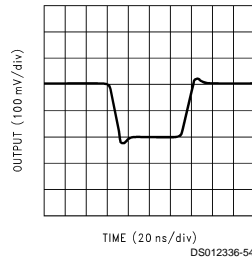

**Small Signal Pulse Response**  
 $A_V = +1, V_S = \pm 15\text{V}$

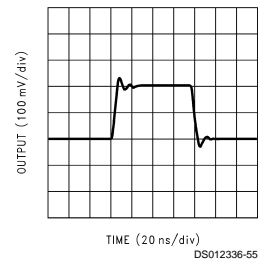

**Small Signal Pulse Response**  
 $A_V = +1, V_S = \pm 5\text{V}$

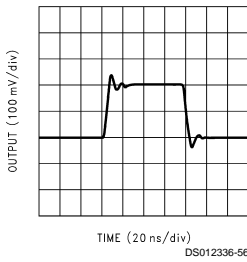

**Small Signal Pulse Response**  
 $A_V = +2, V_S = \pm 15\text{V}$

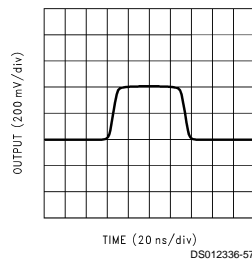

**Small Signal Pulse Response**  
 $A_V = +2, V_S = \pm 5\text{V}$

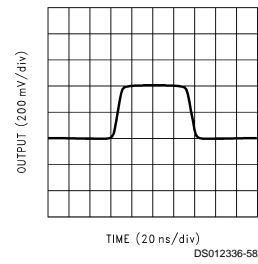

**Closed Loop Frequency Response vs Supply Voltage ( $A_V = +1$ )**

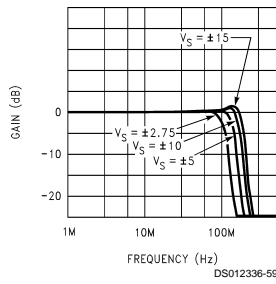

**Closed Loop Frequency Response vs Supply Voltage ( $A_V = +2$ )**

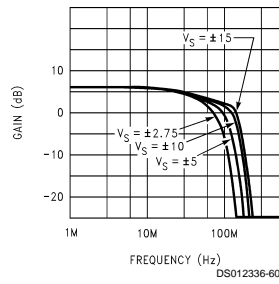

**Closed Loop Frequency Response vs Capacitive Load ( $A_V = +1$ )**

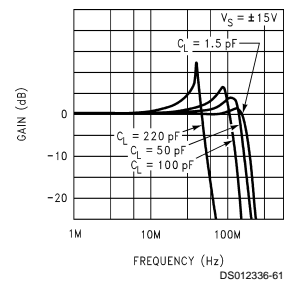

**Typical Performance Characteristics** Unless otherwise noted,  $T_A = 25^\circ\text{C}$  (Continued)

**Closed Loop Frequency Response vs Capacitive Load ( $A_V = +1$ )**

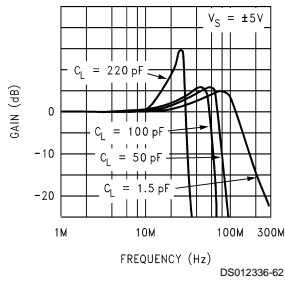

**Closed Loop Frequency Response vs Capacitive Load ( $A_V = +2$ )**

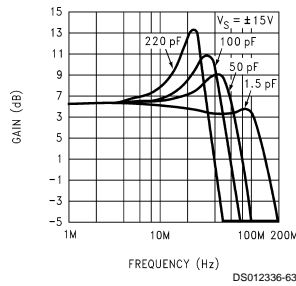

**Closed Loop Frequency Response vs Capacitive Load ( $A_V = +2$ )**

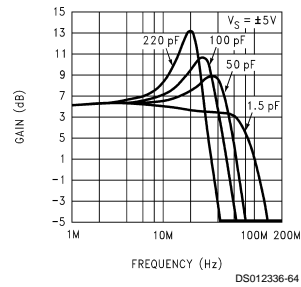

**Total Harmonic Distortion vs Frequency**

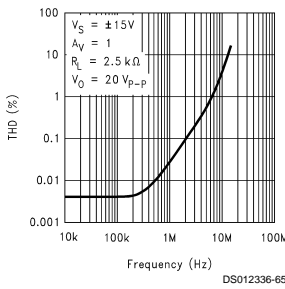

**Total Harmonic Distortion vs Frequency**

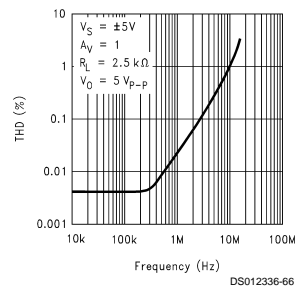

**Total Harmonic Distortion vs Frequency**

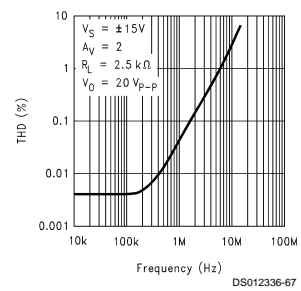

**Total Harmonic Distortion vs Frequency**

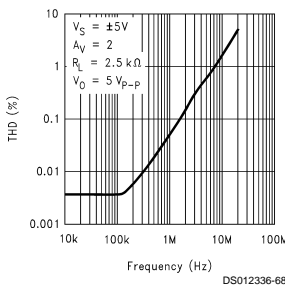

**Undistorted Output Swing vs Frequency**

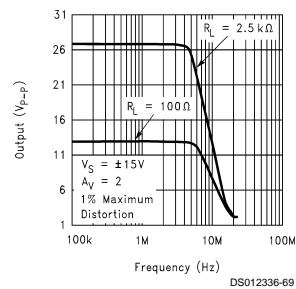

**Undistorted Output Swing vs Frequency**

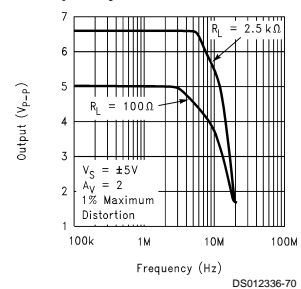

## Typical Performance Characteristics Unless otherwise noted, $T_A = 25^\circ\text{C}$ (Continued)

**Undistorted Output Swing vs Frequency**

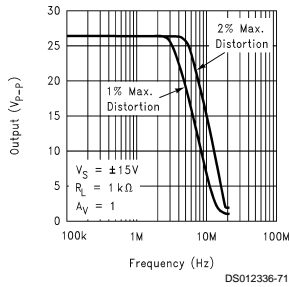

**Undistorted Output Swing vs Frequency**

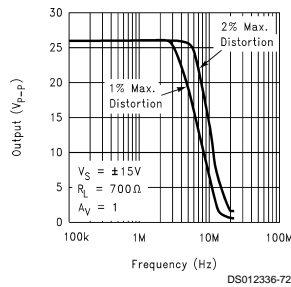

**Total Power Dissipation vs Ambient Temperature**

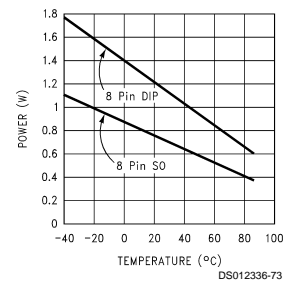

## LM6171 Simplified Schematic

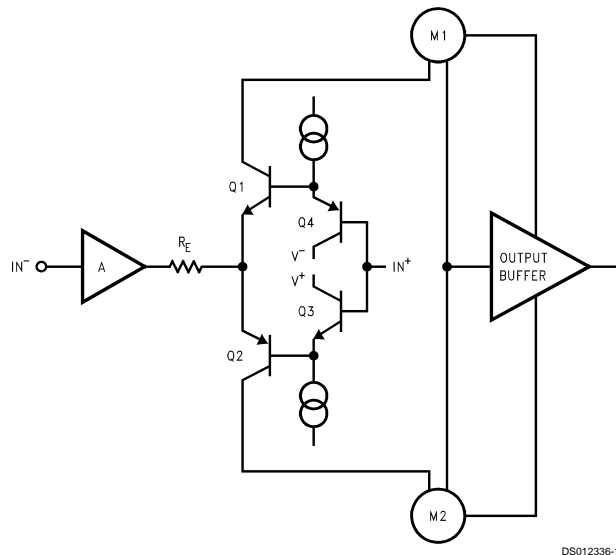

## Application Information

### LM6171 Performance Discussion

The LM6171 is a high speed, unity-gain stable voltage feedback amplifier. It consumes only 2.5 mA supply current while providing a gain-bandwidth product of 100 MHz and a slew rate of 3600V/μs. It also has other great features such as low differential gain and phase and high output current. The LM6171 is a good choice in high speed circuits.

The LM6171 is a true voltage feedback amplifier. Unlike current feedback amplifiers (CFAs) with a low inverting input impedance and a high non-inverting input impedance, both inputs of voltage feedback amplifiers (VFAs) have high impedance nodes. The low impedance inverting input in CFAs will couple with feedback capacitor and cause oscillation. As a result, CFAs cannot be used in traditional op amp circuits such as photodiode amplifiers, I-to-V converters and integrators.

### LM6171 Circuit Operation

The class AB input stage in LM6171 is fully symmetrical and has a similar slewing characteristic to the current feedback amplifiers. In the LM6171 Simplified Schematic, Q1 through Q4 form the equivalent of the current feedback input buffer,  $R_E$  the equivalent of the feedback resistor, and stage A buffers the inverting input. The triple-buffered output stage isolates the gain stage from the load to provide low output impedance.

### LM6171 Slew Rate Characteristic

The slew rate of LM6171 is determined by the current available to charge and discharge an internal high impedance node capacitor. The current is the differential input voltage divided by the total degeneration resistor  $R_E$ . Therefore, the

## Application Information (Continued)

slew rate is proportional to the input voltage level, and the higher slew rates are achievable in the lower gain configurations.

When a very fast large signal pulse is applied to the input of an amplifier, some overshoot or undershoot occurs. By placing an external series resistor such as 1 kΩ to the input of LM6171, the bandwidth is reduced to help lower the overshoot.

### Layout Consideration

#### PRINTED CIRCUIT BOARDS AND HIGH SPEED OP AMPS

There are many things to consider when designing PC boards for high speed op amps. Without proper caution, it is very easy and frustrating to have excessive ringing, oscillation and other degraded AC performance in high speed circuits. As a rule, the signal traces should be short and wide to provide low inductance and low impedance paths. Any unused board space needs to be grounded to reduce stray signal pickup. Critical components should also be grounded at a common point to eliminate voltage drop. Sockets add capacitance to the board and can affect frequency performance. It is better to solder the amplifier directly into the PC board without using any socket.

#### USING PROBES

Active (FET) probes are ideal for taking high frequency measurements because they have wide bandwidth, high input impedance and low input capacitance. However, the probe ground leads provide a long ground loop that will produce errors in measurement. Instead, the probes can be grounded directly by removing the ground leads and probe jackets and using scope probe jacks.

#### COMPONENTS SELECTION AND FEEDBACK RESISTOR

It is important in high speed applications to keep all component leads short because wires are inductive at high frequency. For discrete components, choose carbon composition-type resistors and mica-type capacitors. Surface mount components are preferred over discrete components for minimum inductive effect.

Large values of feedback resistors can couple with parasitic capacitance and cause undesirable effects such as ringing or oscillation in high speed amplifiers. For LM6171, a feedback resistor of 510Ω gives optimal performance.

#### Compensation for Input Capacitance

The combination of an amplifier's input capacitance with the gain setting resistors adds a pole that can cause peaking or oscillation. To solve this problem, a feedback capacitor with a value

$$C_F > (R_G \times C_{IN})/R_F$$

can be used to cancel that pole. For LM6171, a feedback capacitor of 2 pF is recommended. *Figure 1* illustrates the compensation circuit.

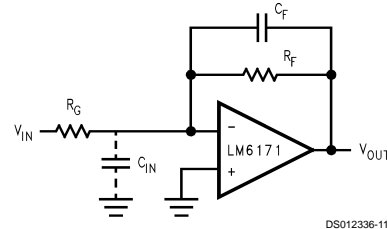

FIGURE 1. Compensating for Input Capacitance

#### Power Supply Bypassing

Bypassing the power supply is necessary to maintain low power supply impedance across frequency. Both positive and negative power supplies should be bypassed individually by placing 0.01 μF ceramic capacitors directly to power supply pins and 2.2 μF tantalum capacitors close to the power supply pins.

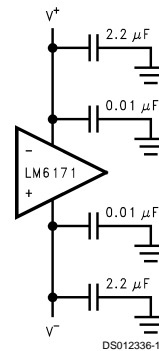

FIGURE 2. Power Supply Bypassing

#### Termination

In high frequency applications, reflections occur if signals are not properly terminated. *Figure 3* shows a properly terminated signal while *Figure 4* shows an improperly terminated signal.

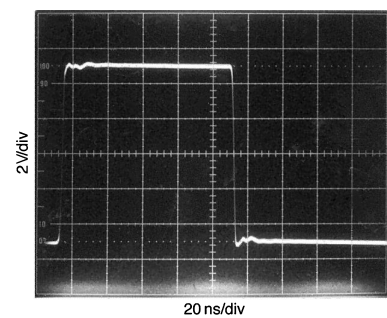
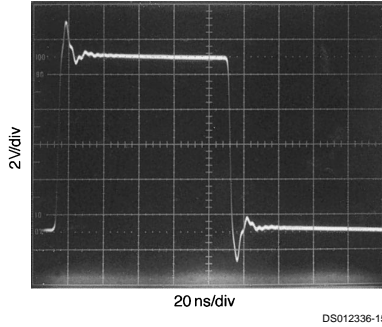

FIGURE 3. Properly Terminated Signal

## Application Information (Continued)

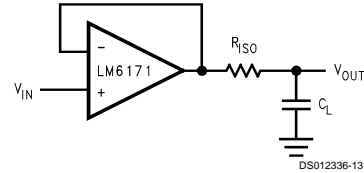

**FIGURE 4. Improperly Terminated Signal**

To minimize reflection, coaxial cable with matching characteristic impedance to the signal source should be used. The other end of the cable should be terminated with the same value terminator or resistor. For the commonly used cables, RG59 has 75 $\Omega$  characteristic impedance, and RG58 has 50 $\Omega$  characteristic impedance.

### Driving Capacitive Loads

Amplifiers driving capacitive loads can oscillate or have ringing at the output. To eliminate oscillation or reduce ringing, an isolation resistor can be placed as shown below in *Figure 5*. The combination of the isolation resistor and the load capacitor forms a pole to increase stability by adding more phase margin to the overall system. The desired performance depends on the value of the isolation resistor; the bigger the isolation resistor, the more damped the pulse response becomes. For LM6171, a 50 $\Omega$  isolation resistor is recommended for initial evaluation. *Figure 6* shows the LM6171 driving a 200 pF load with the 50 $\Omega$  isolation resistor.



**FIGURE 5. Isolation Resistor Used to Drive Capacitive Load**

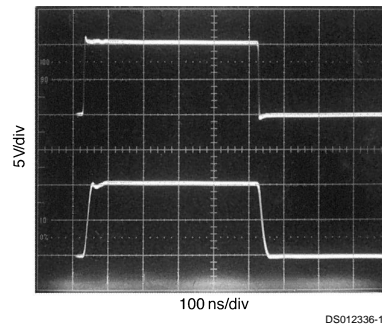

**FIGURE 6. The LM6171 Driving a 200 pF Load with a 50 $\Omega$  Isolation Resistor**

### Power Dissipation

The maximum power allowed to dissipate in a device is defined as:

$$P_D = (T_{J(max)} - T_A) / \theta_{JA}$$

Where  $P_D$  is the power dissipation in a device

$T_{J(max)}$  is the maximum junction temperature

$T_A$  is the ambient temperature

$\theta_{JA}$  is the thermal resistance of a particular package

For example, for the LM6171 in a SO-8 package, the maximum power dissipation at 25 $^{\circ}$ C ambient temperature is 730 mW.

Thermal resistance,  $\theta_{JA}$ , depends on parameters such as die size, package size and package material. The smaller the die size and package, the higher  $\theta_{JA}$  becomes. The 8-pin DIP package has a lower thermal resistance (108 $^{\circ}$ C/W) than that of 8-pin SO (172 $^{\circ}$ C/W). Therefore, for higher dissipation capability, use an 8-pin DIP package.

## Application Information (Continued)

The total power dissipated in a device can be calculated as:

$$P_D = P_Q + P_L$$

$P_Q$  is the quiescent power dissipated in a device with no load connected at the output.  $P_L$  is the power dissipated in the device with a load connected at the output; it is not the power dissipated by the load.

Furthermore,

$P_Q$  = supply current x total supply voltage with no load

$P_L$  = output current x (voltage difference between supply voltage and output voltage of the same supply)

For example, the total power dissipated by the LM6171 with  $V_S = \pm 15V$  and output voltage of 10V into 1 k $\Omega$  load resistor (one end tied to ground) is

$$\begin{aligned} P_D &= P_Q + P_L \\ &= (2.5 \text{ mA}) \times (30V) + (10 \text{ mA}) \times (15V - 10V) \\ &= 75 \text{ mW} + 50 \text{ mW} \\ &= 125 \text{ mW} \end{aligned}$$

## Application Circuits

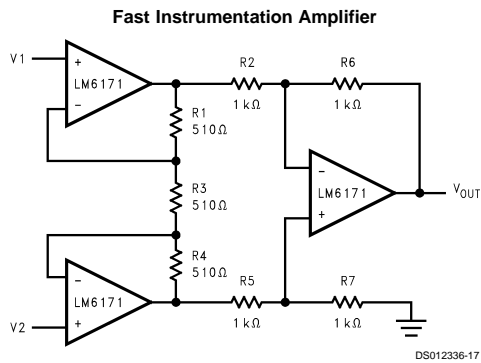

$$V_{IN} = V_2 - V_1$$

if  $R_6 = R_2$ ,  $R_7 = R_5$  and  $R_1 = R_4$

$$\frac{V_{OUT}}{V_{IN}} = \frac{R_6}{R_2} \left( 1 + 2 \frac{R_1}{R_3} \right) = 3$$

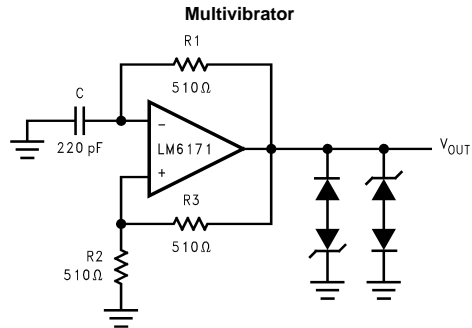

$$f = \frac{1}{2 \left( R_1 C \ln \left( 1 + 2 \frac{R_2}{R_3} \right) \right)}$$

$$f = 4 \text{ MHz}$$

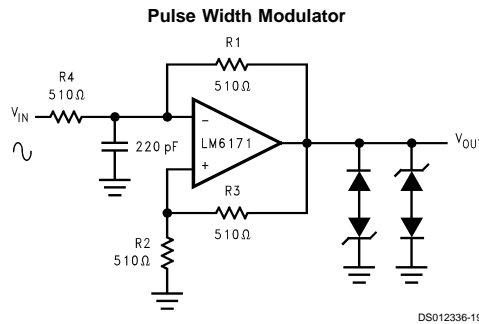

### Design Kit

A design kit is available for the LM6171. The design kit contains:

- High Speed Evaluation Board
- LM6171 in 8-pin DIP Package
- LM6171 Datasheet
- Pspice Macromodel Diskette With the LM6171 Macromodel
- An Amplifier Selection Guide

### Pitch Pack

A pitch pack is available for the LM6171. The pitch pack contains:

- High Speed Evaluation Board
- LM6171 in 8-pin DIP Package
- LM6171 Datasheet
- Pspice Macromodel Diskette With the LM6171 Macromodel

Contact your local National Semiconductor sales office to obtain a pitch pack.

**Physical Dimensions** inches (millimeters) unless otherwise noted

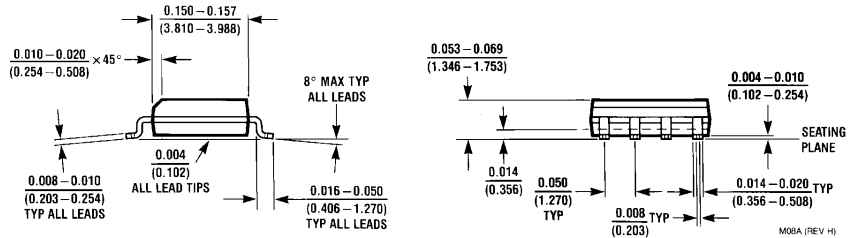
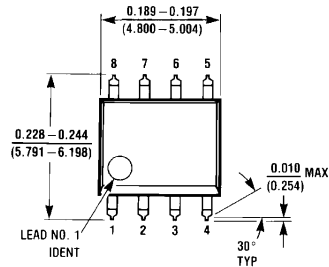

**8-Pin Small Outline Package**  
NS Package Number M08A

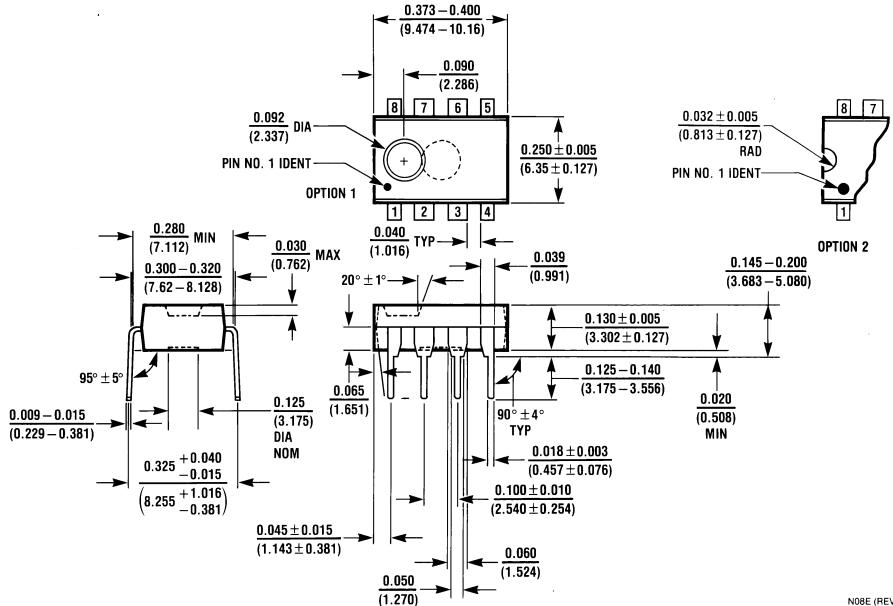

**8-Pin Molded DIP Package**  
NS Package Number N08E



## Notes

### LIFE SUPPORT POLICY

NATIONAL'S PRODUCTS ARE NOT AUTHORIZED FOR USE AS CRITICAL COMPONENTS IN LIFE SUPPORT DEVICES OR SYSTEMS WITHOUT THE EXPRESS WRITTEN APPROVAL OF THE PRESIDENT OF NATIONAL SEMICONDUCTOR CORPORATION. As used herein:

1. Life support devices or systems are devices or systems which, (a) are intended for surgical implant into the body, or (b) support or sustain life, and whose failure to perform when properly used in accordance with instructions for use provided in the labeling, can be reasonably expected to result in a significant injury to the user.
2. A critical component is any component of a life support device or system whose failure to perform can be reasonably expected to cause the failure of the life support device or system, or to affect its safety or effectiveness.



**National Semiconductor Corporation**  
Americas  
Tel: 1-800-272-9959  
Fax: 1-800-737-7018  
Email: support@nsc.com

www.national.com

**National Semiconductor Europe**

Fax: +49 (0) 1 80-530 85 86  
Email: europe.support@nsc.com  
Deutsch Tel: +49 (0) 1 80-530 85 85  
English Tel: +49 (0) 1 80-532 78 32  
Français Tel: +49 (0) 1 80-532 93 58  
Italiano Tel: +49 (0) 1 80-534 16 80

**National Semiconductor Asia Pacific Customer Response Group**

Tel: 65-2544466  
Fax: 65-2504466  
Email: sea.support@nsc.com

**National Semiconductor Japan Ltd.**

Tel: 81-3-5639-7560  
Fax: 81-3-5639-7507