

LM6182 Dual 100 mA Output, 100 MHz Current Feedback Amplifier

General Description

The LM6182 dual current feedback amplifier offers an unparalleled combination of bandwidth, slew-rate, and output current. Each amplifier can directly drive a 2V signal into a 50Ω or 75Ω back-terminated coax cable system over the full industrial temperature range. This represents a radical enhancement in output drive capability for a dual 8-pin high-speed amplifier making it ideal for video applications.

Built on National's advanced high-speed VIP II™ (Vertically Integrated PNP) process, the LM6182 employs current-feedback providing bandwidth that does not vary dramatically with gain; 100 MHz at $A_v = -1$, 60 MHz at $A_v = -10$. With a slew rate of 2000 V/μsec, 2nd harmonic distortion of -50 dBc at 10 MHz and settling time of 50 ns (0.1%), the two independent amplifiers of the LM6182 offer performance that is ideal for data acquisition, high-speed ATE, and precision pulse amplifier applications.

See the LM6181 data sheet for a single amplifier with these same features.

Features

(Typical unless otherwise noted)

- Slew Rate: 2000 V/μs
- Closed Loop Bandwidth: 100 MHz
- Settling Time (0.1%): 50 ns
- Low Differential Gain and Phase Error: 0.05%, 0.04°
 $R_L = 150\Omega$
- Low Offset Voltage: 2 mV
- High Output Drive: ±10V into 150Ω
- Characterized for Supply Ranges: ±5V and ±15V
- Improved Performance over OP260 and LT1229

Applications

- Coax Cable Driver
- Professional Studio Video Equipment
- Flash ADC Buffer
- PC and Workstation Video Boards
- Facsimile and Imaging Systems

Typical Application

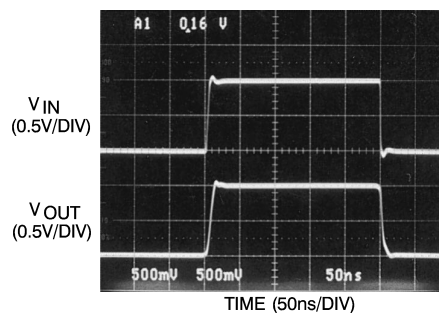
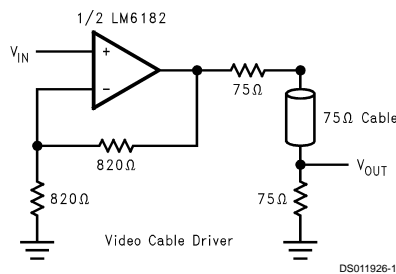

VIP II™ is a trademark of National Semiconductor Corporation.

Connection Diagrams

Dual-In-Line Package (J)

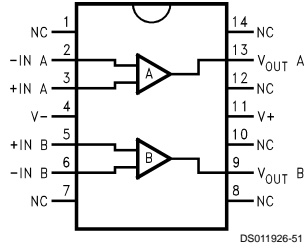

Order Number LM6182AMJ/883
See NS Package Number J14A

Small Outline Package (M)

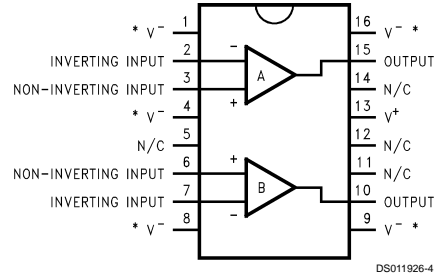

*Heat Sinking Pins (Note 3)

Order Number LM6182IM or LM6182AIM
See NS Package Number M16A

Dual-In-Line Package (N)

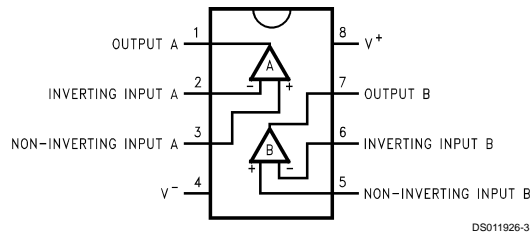

Order Number LM6182IN, LM6182AIN or LM6182AMN
See NS Package Number N08E

Absolute Maximum Ratings (Note 1)

If Military/Aerospace specified devices are required, please contact the National Semiconductor Sales Office/Distributors for availability and specifications.

| | |
|----------------------------|-----------------|
| Supply Voltage | ±18V |
| Differential Input Voltage | ±6V |
| Input Voltage | ±Supply Voltage |
| Inverting Input Current | 15 mA |
| Output Short Circuit | (Note 4) |

Soldering Information

| | |
|---------------------------|---------------------------------|
| Dual-In-Line Package (N) | |
| Soldering (10s) | 260°C |
| Small Outline Package (M) | |
| Vapor Phase (60s) | 215°C |
| Infrared (15s) | 220°C |
| Storage Temperature Range | -65°C ≤ T _J ≤ +150°C |
| Junction Temperature | 150°C |
| ESD Rating (Note 2) | ±2000V |

Operating Ratings

| | |
|-------------------------------------|---------------------------------|
| Supply Voltage Range | 7V to 32V |
| Junction Temperature Range (Note 3) | |
| LM6182AM | -55°C ≤ T _J ≤ +125°C |
| LM6182AI, LM6182I | -40°C ≤ T _J ≤ +85°C |

±15V DC Electrical Characteristics

The following specifications apply for supply voltage = ±15V, V_{cm} = V_O = 0V, R_f = 820Ω, and R_L = 1 kΩ unless otherwise noted. **Boldface** limits apply at the temperature extremes; all other limits T_J = 25°C.

| Symbol | Parameter | Conditions | Typical (Note 5) | LM6182AM | LM6182AI | LM6182I | Units |
|-----------------------|--|------------------------------------|---------------------|--------------------|--------------------|---------------------|-------------|
| | | | | Limit (Note 6) | Limit (Note 6) | Limit (Note 6) | |
| V _{OS} | Input Offset Voltage | | 2.0 | 3.0 4.0 | 3.0 3.5 | 5.0 5.5 | mV max |
| TCV _{OS} | Input Offset Voltage Drift | | 5.0 | | | | μV/°C |
| I _B | Inverting Input Bias Current | | 2.0 | 5.0 12.0 | 5.0 12.0 | 10.0 17.0 | μA max |
| | Non-Inverting Input Bias Current | | 0.75 | 2.0 4.0 | 2.0 4.0 | 3.0 5.0 | |
| TCI _B | Inverting Input Bias Current Drift | | 30 | | | | nA/°C |
| | Non-Inverting Input Bias Current Drift | | 10 | | | | |
| I _B PSR | Inverting Input Bias Current | ±4.5V ≤ V _S ≤ ±16V | 0.1 | 0.5 3.0 | 0.5 3.0 | 0.75 4.5 | μA/V max |
| | Power Supply Rejection | | | | | | |
| | Non-Inverting Input Bias Current | ±4.5V ≤ V _S ≤ ±16V | 0.05 | 0.5 1.5 | 0.5 1.5 | 0.5 3.0 | |
| I _B CMR | Inverting Input Bias Current | -10V ≤ V _{CM} ≤ +10V | 0.15 | 0.5 1.0 | 0.5 1.0 | 0.75 1.5 | |
| | Common Mode Rejection | | | | | | |
| | Non-Inverting Input Bias Current | -10V ≤ V _{CM} ≤ +10V | 0.1 | 0.5 1.0 | 0.5 1.0 | 0.5 1.5 | |
| CMRR | Common Mode Rejection Ratio | -10V ≤ V _{CM} ≤ +10V | 60 | 50 47 | 50 47 | 50 47 | dB min |
| PSRR | Power Supply Rejection Ratio | ±4.5V ≤ V _S ≤ ±16V | 80 | 70 67 | 70 67 | 70 65 | |
| R _O | Output Resistance | A _V = -1 f = 300 kHz | 0.2 | | | | Ω |
| R _{IN} | Non-Inverting Input Resistance | | 10 | | | | MΩ |
| V _O | Output Voltage Swing | R _L = 1 kΩ | 12 | 11 10 | 11 10 | 11 10 | V min |
| | | R _L = 150Ω | 11 | 9.5 5.6 | 9.5 6.0 | 9.5 6.0 | |
| I _{SC} | Output Short Circuit Current | | 100 | 70 37.5 | 70 40 | 70 40 | mA min |
| | | | | | | | |

±15V DC Electrical Characteristics (Continued)

The following specifications apply for supply voltage = ±15V, $V_{cm} = V_O = 0V$, $R_f = 820\Omega$, and $R_L = 1\text{ k}\Omega$ unless otherwise noted. **Boldface** limits apply at the temperature extremes; all other limits $T_J = 25^\circ\text{C}$.

| Symbol | Parameter | Conditions | Typical (Note 5) | LM6182AM | LM6182AI | LM6182I | Units |
|----------|---------------------------------|---|------------------------------|-------------------|--------------------|-------------------|------------------|
| | | | | Limit (Note 6) | Limit (Note 6) | Limit (Note 6) | |
| Z_T | Transimpedance | $R_L = 1\text{ k}\Omega$ | 1.8 | 1.0 0.4 | 1.0 0.5 | 0.8 0.4 | $M\Omega$ min |
| | | $R_L = 150\Omega$ | 1.4 | 0.8 0.3 | 0.8 0.35 | 0.7 0.3 | |
| I_S | Supply Current | No Load, $V_{IN} = 0V$ Both Amplifiers | 15 | 20 22 | 20 22 | 20 22 | mA max |
| V_{CM} | Input Common Mode Voltage Range | | $V^+ - 1.7V$ $V^- + 1.7V$ | | | | V |

±15V AC Electrical Characteristics

The following specifications apply for supply voltage = ±15V, $V_{cm} = V_O = 0V$, $R_f = 820\Omega$, and $R_L = 1\text{ k}\Omega$ unless otherwise noted. **Boldface** limits apply at the temperature extremes; all other limits $T_J = 25^\circ\text{C}$.

| Symbol | Parameter | Conditions | Typical (Note 5) | LM6182AM | LM6182AI | LM6182I | Units |
|---------------|--|---|---------------------|-------------------|-------------------|-------------------|------------------------------|
| | | | | Limit (Note 6) | Limit (Note 6) | Limit (Note 6) | |
| X_t | Crosstalk Rejection | (Note 7) | 93 | | | | dB |
| BW | Closed Loop Bandwidth -3 dB | $A_V = +2$ | 100 | | | | MHz |
| | | $A_V = +10$ | 75 | | | | |
| | | $A_V = -1$ | 100 | | | | |
| | | $A_V = -10$ | 60 | | | | |
| | Closed Loop Bandwidth 0.1 dB Flat, $R_{SOURCE} = 200\Omega$ | $A_V = +2$, $R_L = 150\Omega$ | 35 | | | | |
| PBW | Power Bandwidth | $A_V = -1$, $V_O = 5\text{ V}_{PP}$ | 60 | | | | |
| SR | Slew Rate | Overdriven | 2000 | | | | $V/\mu\text{s}$ min |
| | | $A_V = -1$, $V_O = \pm 10V$ $R_L = 150\Omega$, (Note 8) | 1400 | 1000 | 1000 | 1000 | |
| t_s | Settling Time (0.1%) | $A_V = -1$, $V_O = \pm 5V$ $R_L = 150\Omega$ | 50 | | | | ns |
| t_r , t_f | Rise and Fall Time | $V_O = 1\text{ V}_{PP}$ | 5 | | | | |
| t_p | Propagation Delay Time | $V_O = 1\text{ V}_{PP}$ | 6 | | | | |
| in(+) | Non-Inverting Input Noise Current Density | $f = 1\text{ kHz}$ | 3 | | | | $\text{pA}/\sqrt{\text{Hz}}$ |
| in(-) | Inverting Input Noise Current Density | $f = 1\text{ kHz}$ | 16 | | | | $\text{pA}/\sqrt{\text{Hz}}$ |
| e_n | Input Noise Voltage Density | $f = 1\text{ kHz}$ | 4 | | | | $\text{nV}/\sqrt{\text{Hz}}$ |
| | Second Harmonic Distortion | $V_O = 2\text{ V}_{PP}$, $f = 10\text{ MHz}$ $A_V = +2$ | -50 | | | | dBc |
| | Third Harmonic Distortion | $V_O = 2\text{ V}_{PP}$, $f = 10\text{ MHz}$ $A_V = +2$ | -55 | | | | |
| | Differential Gain | $R_L = 150\Omega$ $A_V = +2$, NTSC | 0.05 | | | | % |
| | Differential Phase | $R_L = 150\Omega$ $A_V = +2$, NTSC | 0.04 | | | | Deg |
| THD | Total Harmonic Distortion | $V_O = 2\text{ V}_{PP}$, $A_V = +2$, $f = 10\text{ MHz}$, $R_L = 150\Omega$ | 0.58 | | | | % |

±5V DC Electrical Characteristics

The following specifications apply for supply voltage = ±5V, $V_{cm} = V_O = 0V$, $R_f = 820\Omega$, and $R_L = 1\text{ k}\Omega$ unless otherwise noted. **Boldface** limits apply at the temperature extremes; all other limits $T_J = 25^\circ\text{C}$.

| Symbol | Parameter | Conditions | Typical (Note 5) | LM6182AM | LM6182AI | LM6182I | Units |
|--------------|--|---|------------------------------|--------------------|---------------------|---------------------|-------------------------------|
| | | | | Limit (Note 6) | Limit (Note 6) | Limit (Note 6) | |
| V_{OS} | Input Offset Voltage | | 1.0 | 2.0 3.0 | 2.0 2.5 | 3.0 3.5 | mV max |
| TCV_{OS} | Input Offset Voltage Drift | | 2.5 | | | | $\mu\text{V}/^\circ\text{C}$ |
| I_B | Inverting Input Bias Current | | 5.0 | 10 22 | 10 22 | 17.5 27.0 | μA max |
| | Non-Inverting Input Bias Current | | 0.25 | 1.5 3.0 | 1.5 3.0 | 3.0 5.0 | |
| TCI_B | Inverting Input Bias Current Drift | | 50 | | | | nA/ $^\circ\text{C}$ |
| | Non-Inverting Input Bias Current Drift | | 3.0 | | | | |
| I_B PSR | Inverting Input Bias Current | $\pm 4V \leq V_S \leq \pm 6V$ | 0.3 | 0.5 1.0 | 0.5 1.0 | 0.75 1.5 | $\mu\text{A}/\text{V}$ max |
| | Power Supply Rejection | | | | | | |
| | Non-Inverting Input Bias Current | $\pm 4V \leq V_S \leq \pm 6V$ | 0.05 | 0.5 1.0 | 0.5 1.0 | 0.5 1.5 | |
| I_B CMR | Inverting Input Bias Current | $-2.5V \leq V_{CM} \leq +2.5V$ | 0.3 | 0.5 1.0 | 0.5 1.0 | 1.0 1.5 | dB min |
| | Common Mode Rejection | | | | | | |
| | Non-Inverting Input Bias Current | $-2.5V \leq V_{CM} \leq +2.5V$ | 0.12 | 0.5 1.0 | 0.5 1.0 | 0.5 1.5 | |
| CMRR | Common Mode Rejection Ratio | $-2.5V \leq V_{CM} \leq +2.5V$ | 57 | 50 47 | 50 47 | 50 47 | |
| PSRR | Power Supply Rejection Ratio | $\pm 4V \leq V_S \leq \pm 6V$ | 80 | 70 67 | 70 67 | 64 60 | |
| R_O | Output Resistance | $A_V = -1$ $f = 300\text{ kHz}$ | 0.25 | | | | Ω |
| R_{IN} | Non-Inverting Input Resistance | | 8 | | | | M Ω |
| V_O | Output Voltage Swing | $R_L = 1\text{ k}\Omega$ | 2.6 | 2.25 2.0 | 2.25 2.0 | 2.25 2.0 | V min |
| | | $R_L = 150\Omega$ | 2.2 | 2.0 1.8 | 2.0 1.8 | 2.0 1.8 | |
| I_{SC} | Output Short Circuit Current | | 100 | 65 35 | 65 40 | 65 40 | mA min |
| | | | | | | | |
| Z_T | Transimpedance | $R_L = 1\text{ k}\Omega$ | 1.4 | 0.75 0.3 | 0.75 0.35 | 0.6 0.3 | M Ω min |
| | | $R_L = 150\Omega$ | 1.0 | 0.5 0.2 | 0.5 0.25 | 0.4 0.2 | |
| I_S | Supply Current | No Load, $V_{IN} = 0V$ Both Amplifiers | 13 | 17 18.5 | 17 18.5 | 17 18.5 | mA max |
| V_{CM} | Input Common Mode Voltage Range | | $V^+ - 1.7V$ $V^- + 1.7V$ | | | | V |

±5V AC Electrical Characteristics

The following specifications apply for supply voltage = ±5V, $V_{cm} = V_O = 0V$, $R_f = 820\Omega$, and $R_L = 1\text{ k}\Omega$ unless otherwise noted. **Boldface** limits apply at the temperature extremes; all other limits $T_J = 25^\circ\text{C}$.

| Symbol | Parameter | Conditions | Typical (Note 5) | LM6182AM | LM6182AI | LM6182I | Units |
|---------------|--|---|---------------------|-------------------|-------------------|-------------------|-------------------------|
| | | | | Limit (Note 6) | Limit (Note 6) | Limit (Note 6) | |
| Xt | Crosstalk Rejection | (Note 7) | 92 | | | | dB |
| BW | Closed Loop Bandwidth -3 dB | $A_V = +2$ | 50 | | | | MHz |
| | | $A_V = +10$ | 40 | | | | |
| | | $A_V = -1$ | 55 | | | | |
| | | $A_V = -10$ | 35 | | | | |
| | Closed Loop Bandwidth 0.1 dB Flat, $R_{SOURCE} = 200\Omega$ | $A_V = +2$, $R_L = 150\Omega$ | 15 | | | | |
| PBW | Power Bandwidth | $A_V = -1$, $V_O = 4 V_{PP}$ | 40 | | | | |
| SR | Slew Rate | $A_V = -1$, $V_O = \pm 2V$ $R_L = 150\Omega$, (Note 8) | 500 | 375 | 375 | 375 | V/ μs min |
| t_s | Settling Time (0.1%) | $A_V = -1$, $V_O = \pm 2V$ $R_L = 150\Omega$ | 50 | | | | ns |
| t_r , t_f | Rise and Fall Time | $V_O = 1 V_{PP}$ | 8.5 | | | | |
| t_p | Propagation Delay Time | $V_O = 1 V_{PP}$ | 8 | | | | |
| in(+) | Non-Inverting Input Noise Current Density | $f = 1\text{ kHz}$ | 3 | | | | pA/ $\sqrt{\text{Hz}}$ |
| in(-) | Inverting Input Noise Current Density | $f = 1\text{ kHz}$ | 16 | | | | pA/ $\sqrt{\text{Hz}}$ |
| e_n | Input Noise Voltage Density | $f = 1\text{ kHz}$ | 4 | | | | nV/ $\sqrt{\text{Hz}}$ |
| | Second Harmonic Distortion | $V_O = 2 V_{PP}$, $f = 10\text{ MHz}$ $A_V = +2$ | -45 | | | | dBc |
| | Third Harmonic Distortion | $V_O = 2 V_{PP}$, $f = 10\text{ MHz}$ $A_V = +2$ | -55 | | | | |
| | Differential Gain | $R_L = 150\Omega$ $A_V = +2$, NTSC | 0.06 | | | | % |
| | Differential Phase | $R_L = 150\Omega$ $A_V = +2$, NTSC | 0.16 | | | | Deg |
| THD | Total Harmonic Distortion | $V_O = 2 V_{PP}$, $A_V = +2$, $f = 5\text{ MHz}$, $R_L = 150\Omega$ | 0.36 | | | | % |

Note 1: Absolute Maximum Ratings indicate limits beyond which damage to the device may occur. Operating ratings indicate conditions for which the device is intended to be functional, but device parameter specifications may not be guaranteed under these conditions. For guaranteed specifications and test conditions, see the Electrical Characteristics.

Note 2: Human body model 100 pF and 1.5 k Ω .

Note 3: The typical junction-to-ambient thermal resistance of the molded plastic DIP(N) soldered directly into a PC board is 95°C/W. The junction-to-ambient thermal resistance of the S.O. surface mount (M) package mounted flush to the PC board is 70°C/W when pins 1,4,8,9 and 16 are soldered to a total of 2 in² 1 oz copper trace. The S.O. (M) package must have pin 4 and at least one of pins 1,8,9, or 16 connected to V- for proper operation.

Note 4: Continuous short circuit operation at elevated ambient temperature can result in exceeding the maximum allowable junction temperature of 150°C. Each amplifier of the LM6182 is short circuit current limited to 100 mA typical.

Note 5: Typical values represent the most likely parametric norm.

Note 6: All limits are guaranteed at room temperature (standard type face) or at operating temperature extremes (boldface type).

Note 7: Each amp excited in turn with 100 kHz to produce $V_O = 2 V_{PP}$. Results are input referred.

Note 8: Measured from +25% to +75% of output waveform.

Note 9: Also available per the Standard Military Drawing, 5962-9460301MCA.

Note 10: For guaranteed military specifications see military datasheet MNL6182AM-X.

±5V AC Electrical Characteristics (Continued)

Simplified Schematic 1/2 LM6182

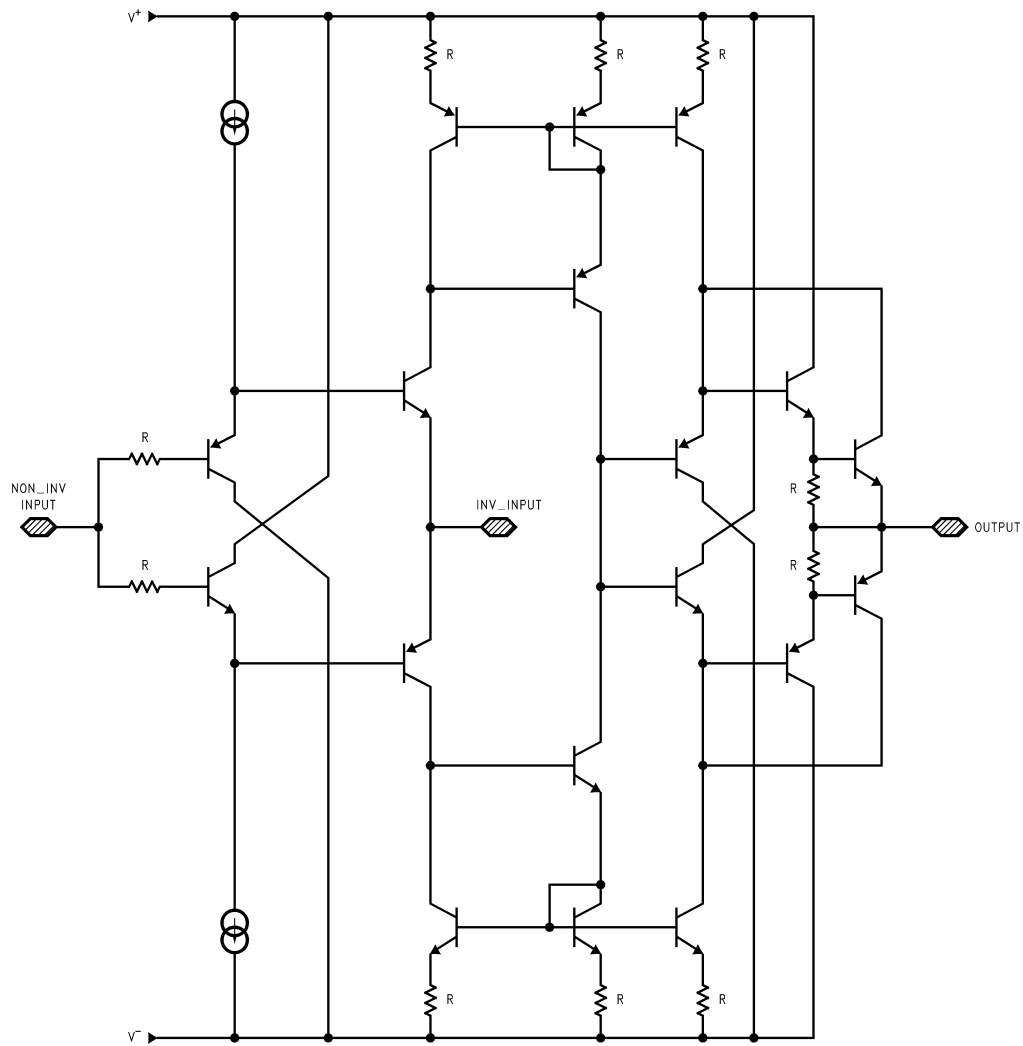

DS011926-6

Typical Performance Characteristics

MAXIMUM POWER DERATING CURVES

N-Package

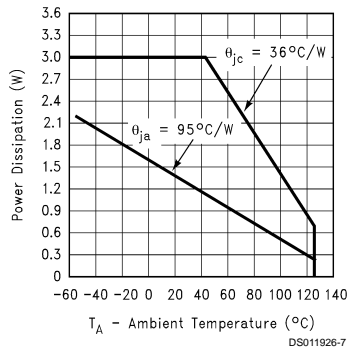

M-Package

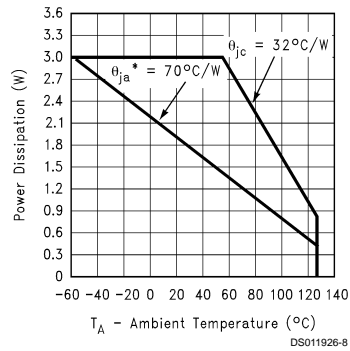

* θ_{ja} = Thermal Resistance with 2 square inches of 1 ounce copper tied to pins 1, 8, 9 and 16

TYPICAL PERFORMANCE TEST CIRCUITS

Non-Inverting:
Small Signal Pulse Response,
Slew Rate, -3 dB Bandwidth

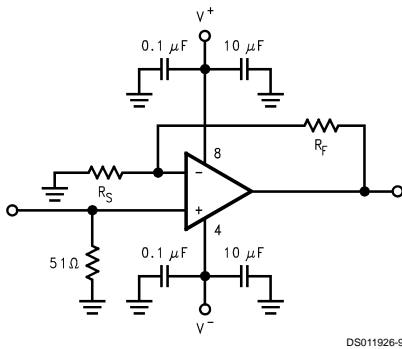

Inverting:
Small Signal Pulse Response,
Slew Rate, -3 dB Bandwidth

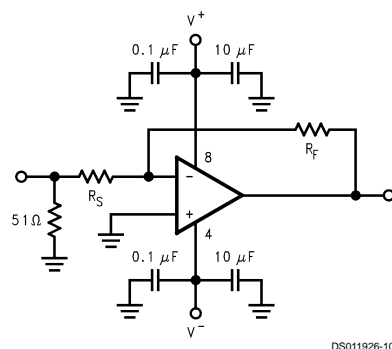

TYPICAL PERFORMANCE TEST CIRCUITS (Continued)

Amplifier-to-Amplifier Isolation

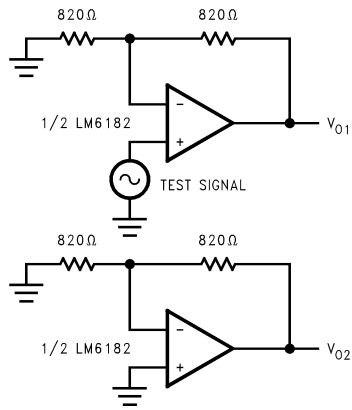

DS011926-11

$$X_T (\text{Crosstalk Rejection}) = \frac{V_{01}}{V_{02}}$$

Input Voltage Noise

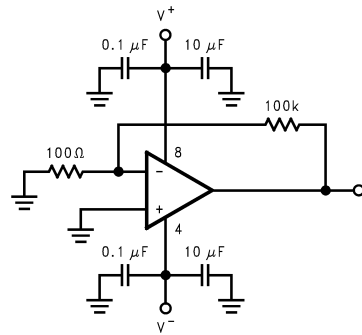

DS011926-12

CMRR

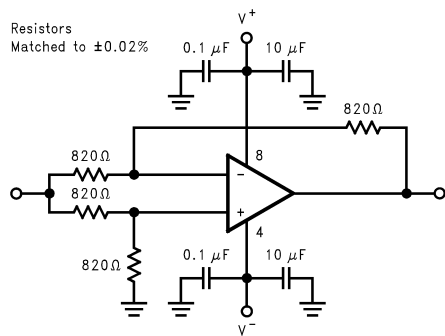

DS011926-13

PSRR (V_{S+})

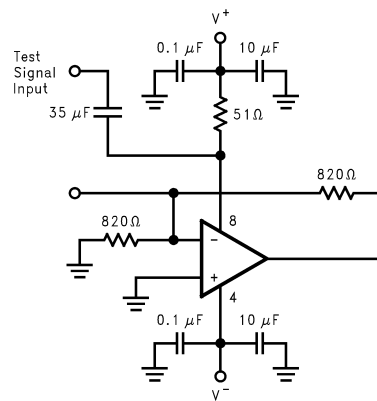

DS011926-14

Typical Performance Characteristics $V_S = \pm 15V$ and $T_A = 25^\circ C$ unless otherwise noted.

Inverting Gain Frequency Response
 $V_S = \pm 15V, A_V = -1, R_f = 820\Omega$

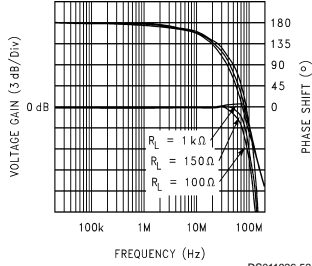

DS011926-52

Inverting Gain Frequency Response
 $V_S = \pm 5V, A_V = -1, R_f = 820\Omega$

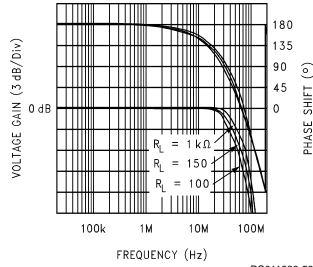

DS011926-53

Non-Inverting Gain Frequency Response
 $V_S = \pm 15V, A_V = +2, R_f = 820\Omega$

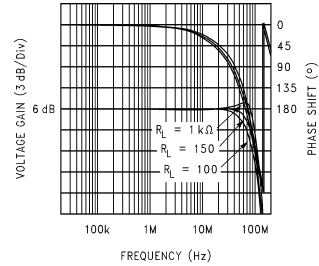

DS011926-54

Non-Inverting Gain Frequency Response
 $V_S = \pm 5V, A_V = +2, R_f = 820\Omega$

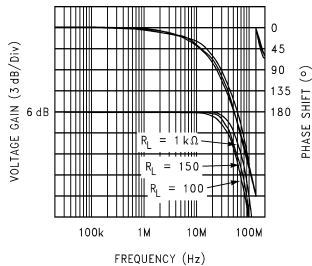

DS011926-55

-3 dB Bandwidth vs Rf and RS, AV = +2

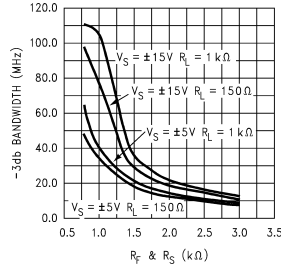

DS011926-56

Inverting Gain vs -3 dB Bandwidth
 $R_f = 820\Omega$

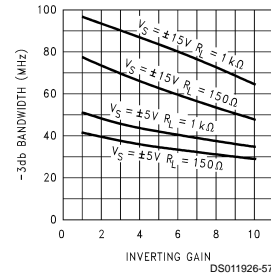

DS011926-57

Non-Inverting Gain vs -3 dB Bandwidth
 $R_f = 820\Omega$

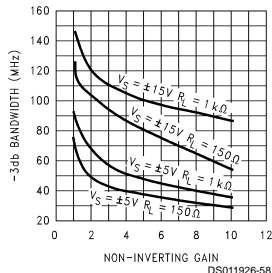

DS011926-58

-3 dB Bandwidth vs Supply Voltage
 $A_V = -1$

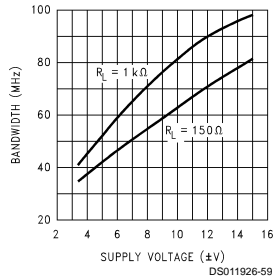

DS011926-59

Transimpedance vs Frequency
 $R_L = 1 k\Omega$

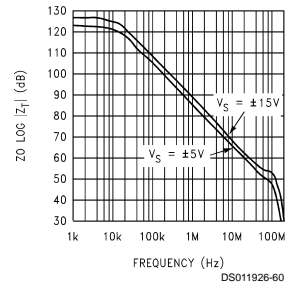

DS011926-60

Typical Performance Characteristics $V_S = \pm 15V$ and $T_A = 25^\circ C$ unless otherwise noted. (Continued)

Transimpedance vs Frequency
 $R_L = 150\Omega$

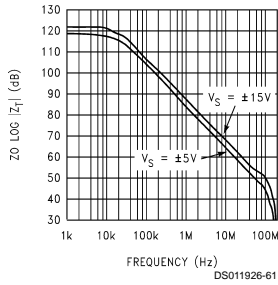

Settling Response
 $V_S = \pm 15V, R_L = 150\Omega$
 $A_V = -1, V_O = \pm 5V$

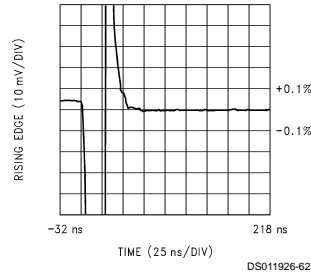

Settling Response
 $V_S = \pm 5V, R_L = 150\Omega$
 $A_V = -1, V_O = \pm 2V$

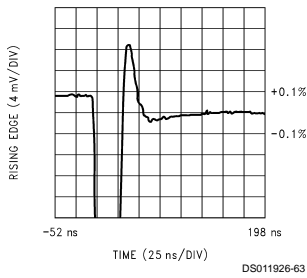

Long Term Settling Time
Response $V_S = \pm 15V,$
 $R_L = 150\Omega, A_V = -1, V_O = \pm 5V$

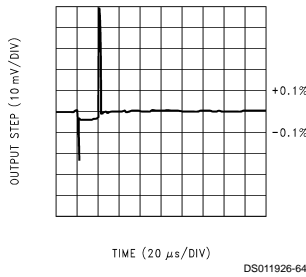

Suggested R_f and R_s for $C_L, A_V = -1$

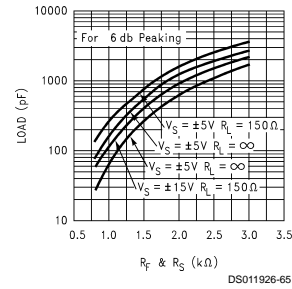

Suggested R_f and R_s for $C_L, A_V = +2$

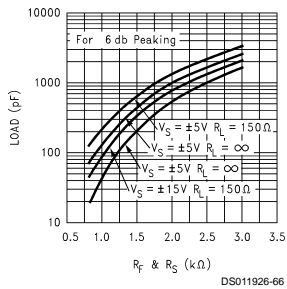

Output Impedance vs Frequency
 $A_V = -1, R_L = 820\Omega$

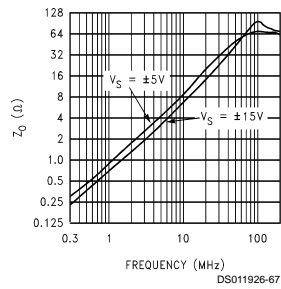

**PSRR (V_{S+}) vs Frequency, $A_V = 2,$
 $R_f = R_s = 820\Omega$**

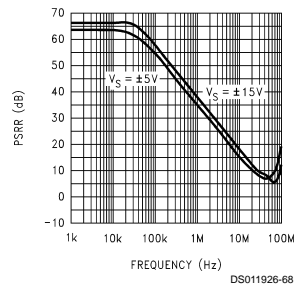

Typical Performance Characteristics $V_S = \pm 15V$ and $T_A = 25^\circ C$ unless otherwise noted. (Continued)

PSRR (V_S) vs Frequency, $A_V = 2$, $R_f = R_s = 820\Omega$

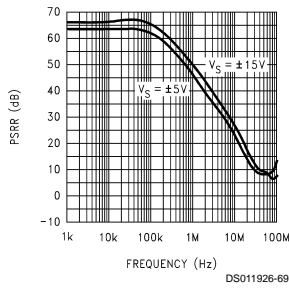

CMRR vs Frequency $R_f = R_s = 820\Omega$

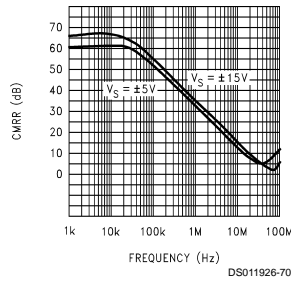

Input Voltage Noise vs Frequency

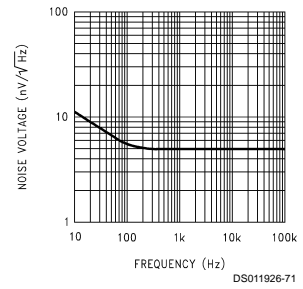

Input Current Noise vs Frequency

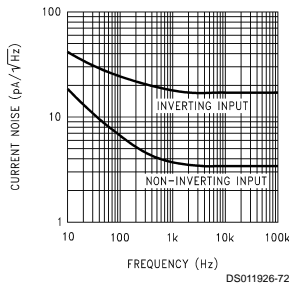

Slew Rate vs Temperature $A_V = -1, R_L = 150\Omega$

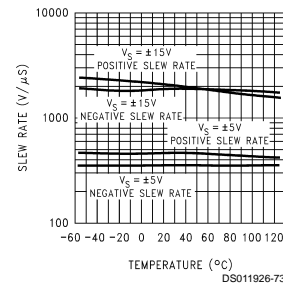

Slew Rate vs Supply Voltage $A_V = -1, R_L = 150\Omega$

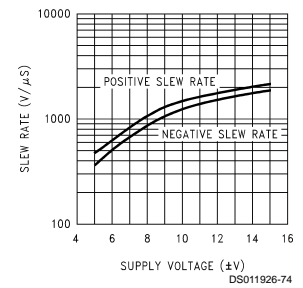

Distortion vs Frequency $V_S = \pm 15V, A_V = +2, R_L = 150\Omega, V_O = 2Vp-p$

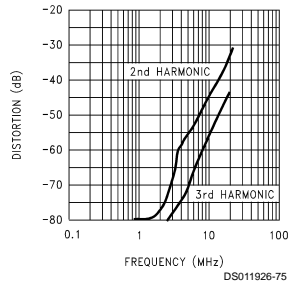

Distortion vs Frequency $V_S = \pm 15V, A_V = -1, R_L = 150\Omega, V_O = 2Vp-p$

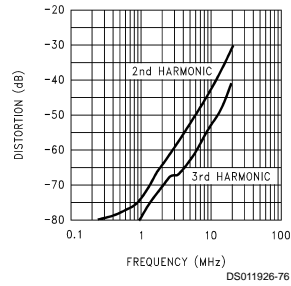

Distortion vs Frequency $V_S = \pm 5V, A_V = +2, R_L = 150\Omega, V_O = 2Vp-p$

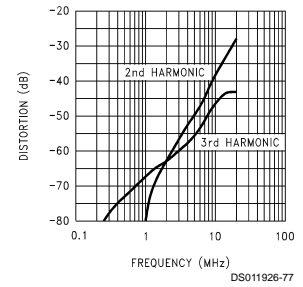

Typical Performance Characteristics $V_S = \pm 15V$ and $T_A = 25^\circ C$ unless otherwise noted. (Continued)

Distortion vs Frequency
 $V_S = \pm 5V, A_V = -1,$
 $R_L = 150\Omega, V_O = 2V_{p-p}$

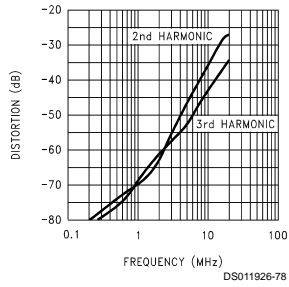

Crosstalk Rejection vs Frequency

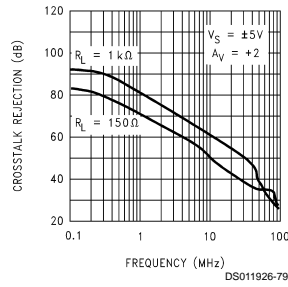

Maximum Output Voltage Swing vs Frequency (THD $\leq 1\%$)

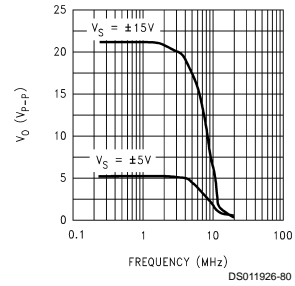

-3 dB Bandwidth vs Temperature, $A_V = -1$

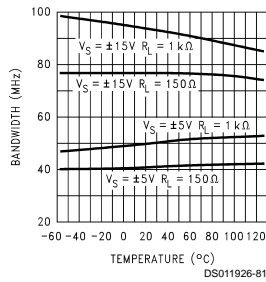

-3 dB Bandwidth vs Temperature, $A_V = +2$

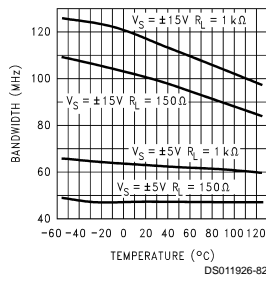

**Small Signal Pulse Response vs Temperature, $A_V = -1,$
 $V_S = \pm 15V, R_L = 1 k\Omega$**

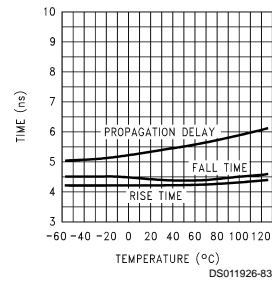

**Small Signal Pulse Response vs Temperature, $A_V = -1,$
 $V_S = \pm 15V, R_L = 150\Omega$**

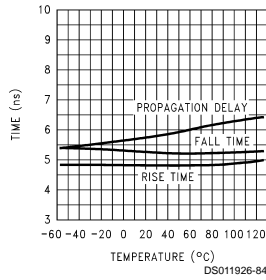

**Small Signal Pulse Response vs Temperature, $A_V = +2,$
 $V_S = \pm 15V, R_L = 1 k\Omega$**

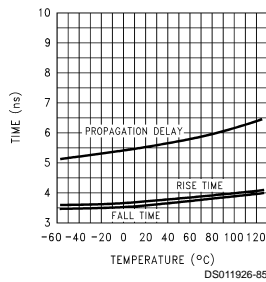

**Small Signal Pulse Response vs Temperature, $A_V = +2,$
 $V_S = \pm 15V, R_L = 150\Omega$**

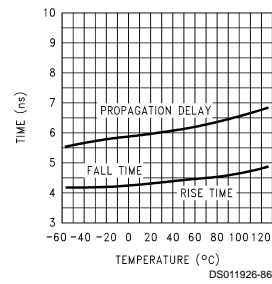

Typical Performance Characteristics $V_S = \pm 15V$ and $T_A = 25^\circ C$ unless otherwise noted. (Continued)

**Settling Time vs Output Step, $R_F = 820\Omega$
 $R_L = 150\Omega$, $A_V = -1$**

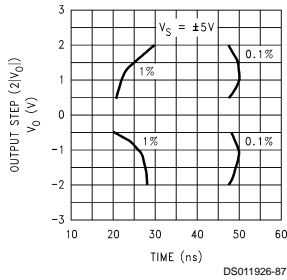

**Settling Time vs Output Step, $R_F = 820\Omega$
 $R_L = 150\Omega$, $A_V = -1$**

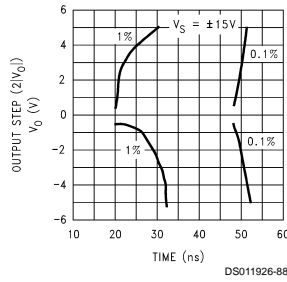

**Small Signal Pulse Response vs Closed-Loop Gain
 $R_L = 1k$**

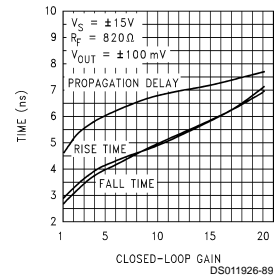

**Small Signal Pulse Response vs Closed-Loop Gain
 $R_L = 150\Omega$**

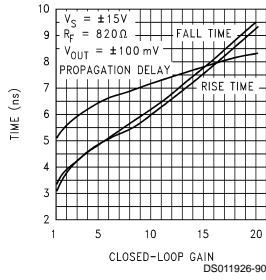

**Small Signal Pulse Response vs Supply Voltage
 $A_V = +2$, $R_L = 1k$**

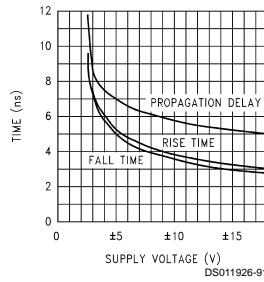

V_{OS} vs Temperature

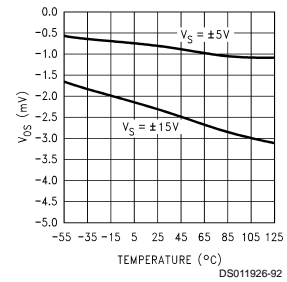

Z_t vs Temperature

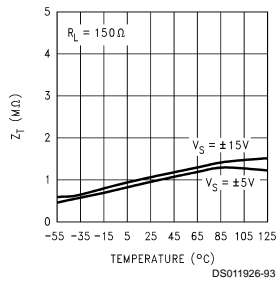

Z_t vs Temperature

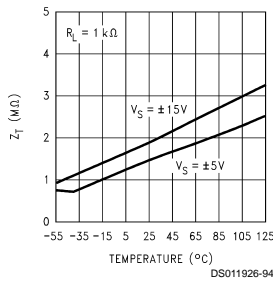

I_S vs Temperature

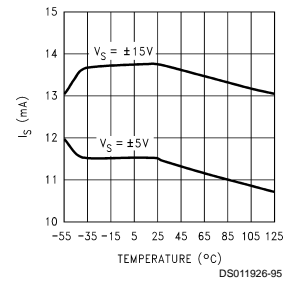

Typical Performance Characteristics $V_S = \pm 15V$ and $T_A = 25^\circ C$ unless otherwise noted. (Continued)

PSRR vs Temperature

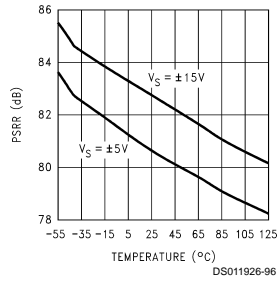

CMRR vs Temperature

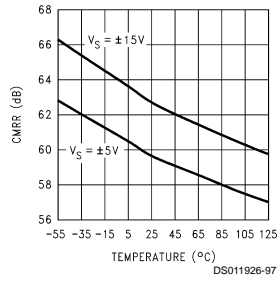

Ib (+) vs Temperature

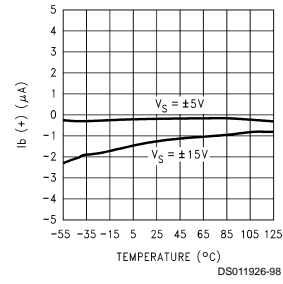

Ib (-) vs Temperature

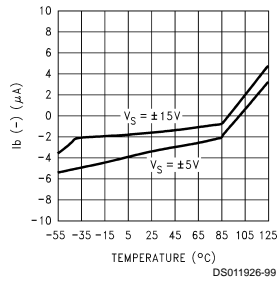

Ib (+) PSR vs Temperature

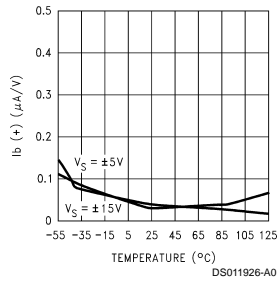

Ib (-) PSR vs Temperature

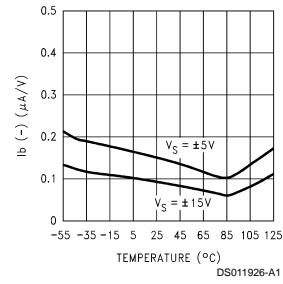

Ib (+) CMR vs Temperature

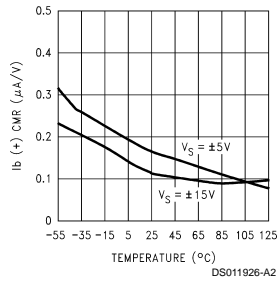

Ib (-) CMR vs Temperature

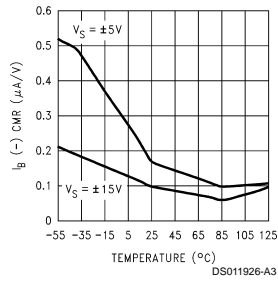

Isc(±) vs Temperature

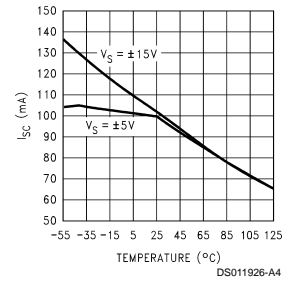

Output Swing vs Temperature

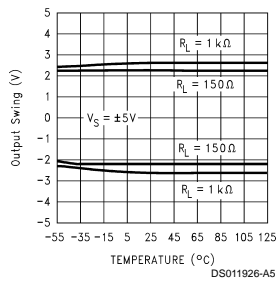

Output Swing vs Temperature

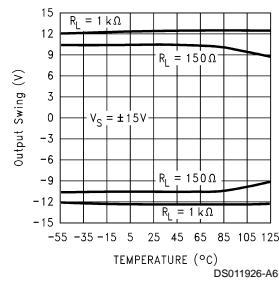

Typical Applications

CURRENT FEEDBACK TOPOLOGY

For a conventional voltage feedback amplifier the resulting small-signal bandwidth is inversely proportional to the desired gain to a first order approximation based on the gain-bandwidth concept. In contrast, the current feedback amplifier topology, such as the LM6182, transcends this limitation to offer a signal bandwidth that is relatively independent of the closed loop gain. *Figure 1A* and *Figure 1B* illustrate that for closed loop gains of -1 and -5 the resulting pulse fidelity suggests quite similar bandwidths for both configurations.

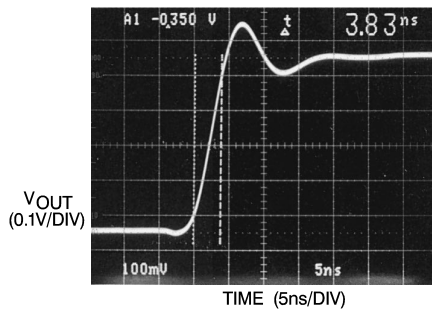

DS011926-20

1A. $A_V = -1$

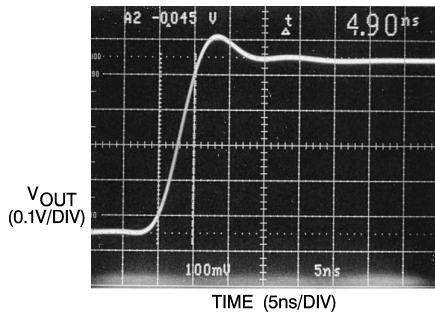

DS011926-21

1B. $A_V = -5$

FIGURE 1. Variation of Closed-Loop Gain from -1 to -5 Yields Similar Responses.

FEEDBACK RESISTOR SELECTION: R_f

Selecting the feedback resistor, R_f , is a dominant factor in compensating the LM6182. For general applications the LM6182 will maintain specified performance with an 820Ω feedback resistor. The closed-loop bandwidth of the LM6182 depends on the feedback resistance, R_f . Therefore, R_s , and not R_f , is varied to adjust for the desired closed-loop gain as demonstrated in *Figure 2*.

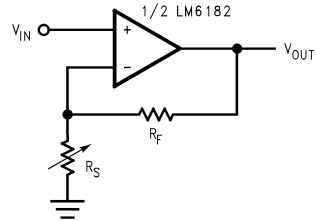

DS011926-22

FIGURE 2. R_f Sets Amplifier Bandwidth and R_s is Adjusted to Obtain the Desired Closed-Loop Gain, A_V .

Although this R_f value will provide good results for most applications, it may be advantageous to adjust this value slightly. Consider, for instance, the effect on pulse responses with two different configurations where both the closed-loop gains are $+2$ and the feedback resistors are 820Ω , and 1640Ω , respectively. *Figure 3A* and *Figure 3B* illustrate the effect of increasing R_f while maintaining the same closed-loop gain – the amplifier bandwidth decreases. Accordingly, larger feedback resistors can be used to slow down the LM6182 and reduce overshoot in the time domain response. Conversely, smaller feedback resistance values than 820Ω can be used to compensate for the reduction of bandwidth at high closed-loop gains, due to 2nd order effects. For example *Figure 4A* and *Figure 4B* illustrate reducing R_f to 500Ω to establish the desired small signal response in an amplifier configured for a closed-loop gain of $+25$.

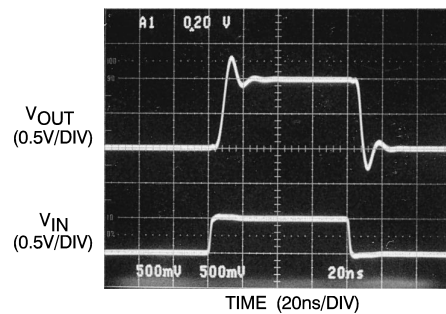

DS011926-23

3A. $R_f = 820\Omega$

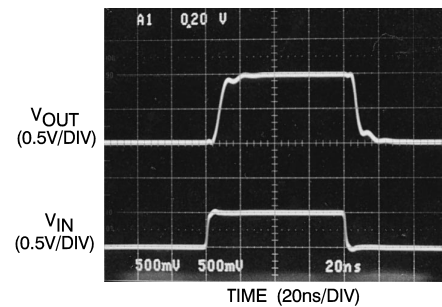

DS011926-24

3B. $R_f = 1640\Omega$

FIGURE 3. Increase Compensation by Increasing R_f , $A_V = +2$

Typical Applications (Continued)

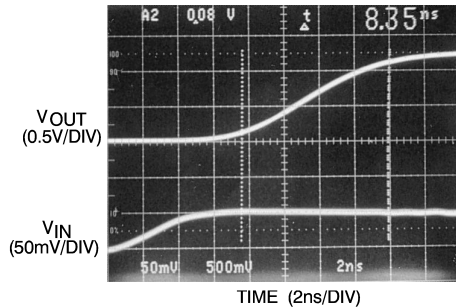

DS011926-25

4A. $R_f = 820\Omega$

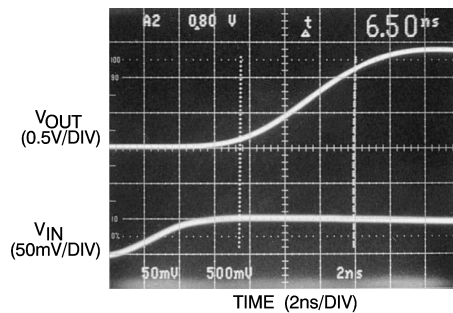

DS011926-26

4B. $R_f = 500\Omega$

FIGURE 4. , 4B. Reducing R_f to Increase Bandwidth for Large Closed-Loop Gains, $A_v = +25$

The extent of the amplifier's dependence on R_f is displayed in Figure 5 for one particular closed-loop gain.

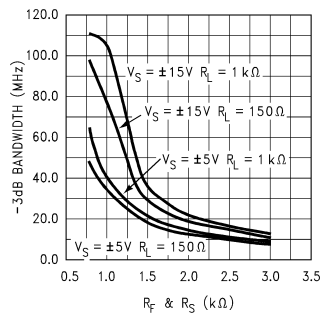

DS011926-27

FIGURE 5. -3 dB Bandwidth Is Determined By Selecting R_f .

CAPACITIVE FEEDBACK

Current feedback amplifiers rely on feedback impedance for proper compensation. Even in unity gain current feedback amplifiers require a feedback resistor. LM6182 performance is specified for a feedback resistance of 820Ω . Decreasing the feedback impedance below 820Ω extends the amplifier's

bandwidth leading to possible instability. Capacitive feedback should therefore not be used because the impedance of a capacitor decreases with increasing frequency.

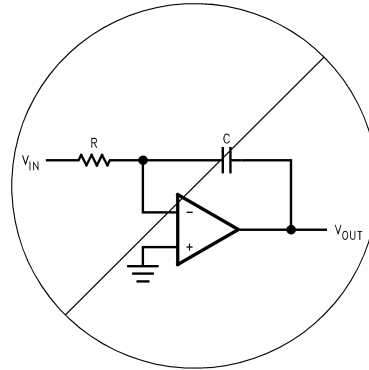

DS011926-28

FIGURE 6. Current Feedback Amplifiers are Unstable with Capacitive Feedback

For voltage feedback amplifiers it is quite common to place a small lead compensation capacitor in parallel with feedback resistance, R_f . This compensation serves to reduce the amplifier's peaking. One application of the lead compensation capacitor is to counteract the effects of stray capacitance from the inverting input to ground in circuit board layouts. The LM6182 current feedback amplifier does not require this lead compensation capacitor and has an even simpler, more elegant solution.

To limit the bandwidth and peaking of the LM6182 current feedback amplifier, do not use a capacitor across R_f as in Figure 7. This actually has the opposite effect and extends the bandwidth of the amplifier leading to possible instability. Instead, simply increase the value of the feedback resistor as shown in Figure 3.

Non-inverting applications can also reduce peaking and limit bandwidth by adding an RC circuit as illustrated in Figure 8.

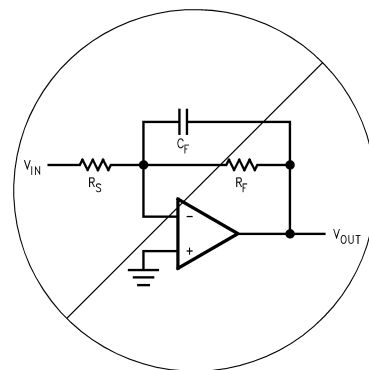

DS011926-29

FIGURE 7. Compensation Capacitors Are Not Used with the LM6182, Instead Simply Increase R_f to Compensate

Typical Applications (Continued)

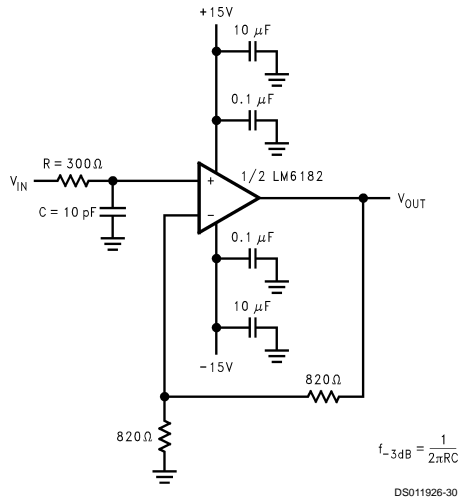

8A

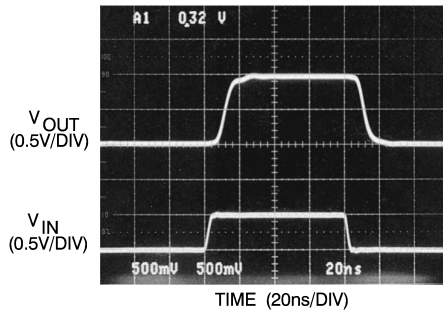

8B

FIGURE 8. RC Limits Amplifier Bandwidth to 50 MHz, Eliminating Peaking in the Resulting Pulse Response as Compared to Figure 3A

SLEW RATE CONSIDERATIONS

The slew rate characteristics of current feedback amplifiers are different than traditional voltage feedback amplifiers. In voltage feedback amplifiers, slew rate limiting or non-linear amplifier behavior is dominated by the finite availability of the 1st stage tail current charging the compensation capacitor. The slew rate of current feedback amplifiers, in contrast, is not constant. Transient current at the inverting input is proportional to the current available to the amplifier's compensation capacitor. The current feedback amplifier is therefore not traditionally slew rate limited. This enables large slew rate responses of 2000 V/μs. The non-inverting configuration slew rate is also determined by input stage limitations. Accordingly, variations of slew rates occur for different circuit topologies.

DRIVING CAPACITIVE LOADS

The LM6182 can drive significantly larger capacitive loads than many current feedback amplifiers. This is extremely valuable for simplifying the design of coax-cable drivers. Although the LM6182 can directly drive as much as 100 pF of load capacitance without oscillating, the resulting response will be a function of the feedback resistor value. Figure 9B illustrates the small-signal pulse response of the LM6182 while driving a 50 pF load. Ringing persists for approximately 100 ns. To achieve pulse responses with less ringing either the feedback resistor can be increased (see Typical Performance Characteristics "Suggested R_f and R_s for C_L"), or resistive isolation can be used (10Ω–51Ω typically works well). Either technique, however, results in lowering the system bandwidth.

Figure 10B illustrates the improvement obtained by using a 47Ω isolation resistor.

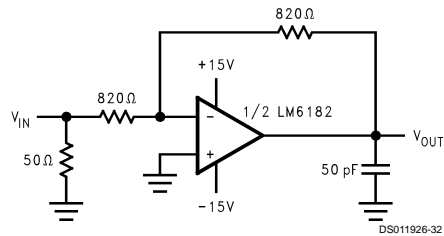

9A

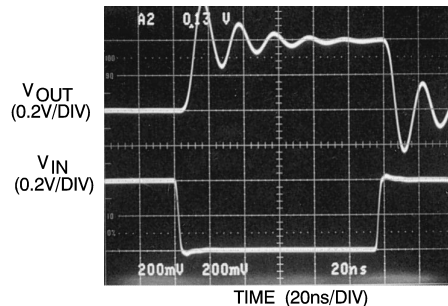

9B

FIGURE 9. A_v = -1, LM6182 Can Directly Drive 50 pF of Load Capacitance with 100 ns of Ringing Resulting in Pulse Response

Typical Applications (Continued)

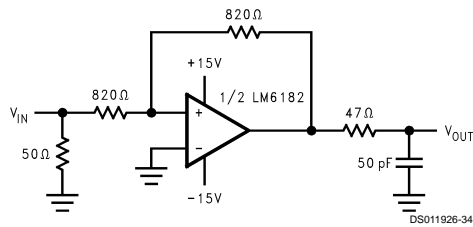

10A

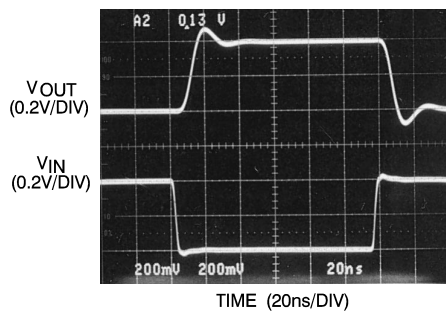

10B

FIGURE 10. Resistive Isolation of C_L Provides Higher Fidelity Pulse Response. R_f and R_s Could Also Be Increased to Maintain $A_v = -1$ and Improve Pulse Response Characteristics.

POWER SUPPLY BYPASSING AND LAYOUT CONSIDERATIONS

A fundamental requirement for high-speed amplifier design is adequate bypassing of the power supply. It is critical to maintain a wideband low-impedance to ground at the amplifiers supply pins to insure the fidelity of high speed amplifier transient signals. 0.1 μ F ceramic bypass capacitors at each supply pin are sufficient for many applications. Typically 10 μ F tantalum capacitors are also required if large current transients are delivered to the load. The bypass capacitors should be placed as close to the amplifier pins as possible, such as 0.5" or less.

Applications requiring high output power, cable drivers for example, cause increased internal power dissipation. Internal power dissipation can be minimized by operating at reduced power supply voltages, such as ± 5 V.

Optimum heat dissipation is achieved by using wide circuit board traces and soldering the part directly onto the board. Large power supply and ground planes will improve power dissipation. Safe Operating Area (S.O.A.) is determined using the Maximum Power Derating Curves.

The 16-pin small outline package (M) has 5 V^- heat sinking pins that enable a junction-to-ambient thermal resistance of 70° C/W when soldered to 2 in² 1 oz. copper trace. A V^- heat sinking pin is located on each corner of the package for ease of layout. This allows high output power and/or operation at elevated ambient temperatures without the additional cost of an integrated circuit heat sink. If the heat sinking capabilities

of the S.O. package are not needed, pin 4 and at least one of pins 1,8,9, or 16 must be connected to V^- for proper operation.

Figure 11 shows recommended copper patterns used to dissipate heat from the LM6182.

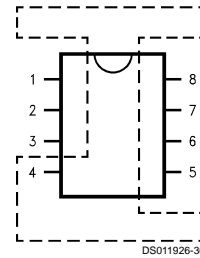

8-pin DIP (N)

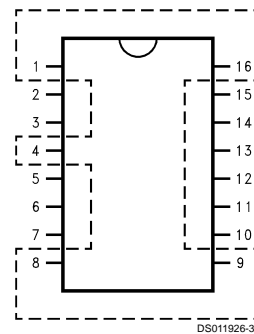

16-pin S.O. (M)

FIGURE 11. Copper Heatsink Layouts

CROSSTALK REJECTION

The LM6182 has an excellent crosstalk rejection value of 62 dB at 10 MHz. This value is made possible because the LM6182 amplifiers share no common circuitry other than the supply. High frequency crosstalk that does appear is primarily caused by the magnetic and capacitive coupling of the internal bond wires. Bond wires connect the die to the package lead frame. The amount of current flowing through the bond wires is proportional to the amount of crosstalk. Therefore, crosstalk rejection ratings will degrade when driving heavy loads. Figure 12 and shows a 10 dB difference for two different loads.

Typical Applications (Continued)

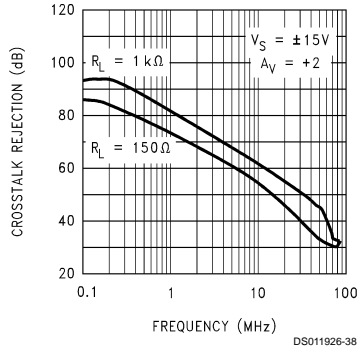

FIGURE 12. Crosstalk Rejection

The LM6182 crosstalk effect is minimized in applications that cascade the amplifiers by preceding amplifier A with amplifier B.

START-UP TIME

Using the circuit in *Figure 13*, the LM6182 demonstrated a start-up time of 50 ns.

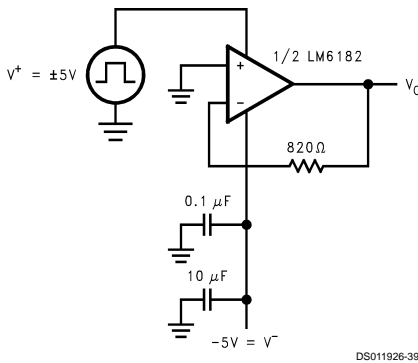

FIGURE 13. Start-Up Test Circuit

OVERDRIVE RECOVERY

The LM6182 is an excellent choice for high speed applications needing fast overdrive recovery. Nanosecond recovery times allow the LM6182 to protect subsequent stages from excessive input saturation and possible damage.

When the output or input voltage range of a high speed amplifier is exceeded, the amplifier must recover from an overdrive condition. The non-linear output voltage remains as long as the overdrive condition persists. Linear operation resumes after the overdrive condition is removed. Overdrive recovery time is the delay before an amplifier returns to linear operation. The typical recovery times for exceeding open loop, closed loop, and input common-mode voltage ranges are illustrated in *Figures 14, 15, 16*.

The open-loop circuit of *Figure 14* generates an overdrive response by allowing the $\pm 0.5V$ input to exceed the linear input range of the amplifier. Typical positive and negative overdrive recovery times are 5 ns and 30 ns, respectively.

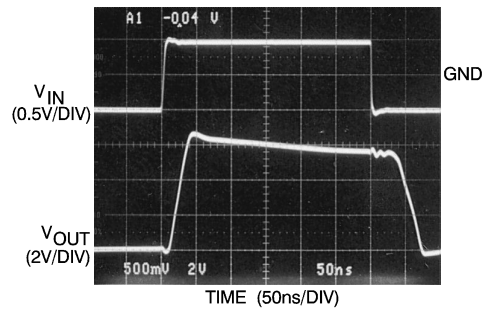
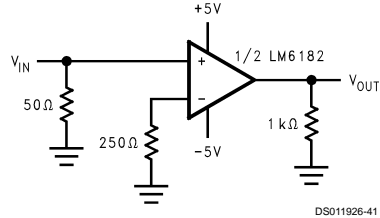

FIGURE 14. Open Loop Overdrive Recovery Times of 5 ns and 30 ns

The large closed-loop gain configuration in *Figure 15* forces the amplifier output into overdrive. The typical recovery time to a linear output value is 15 ns.

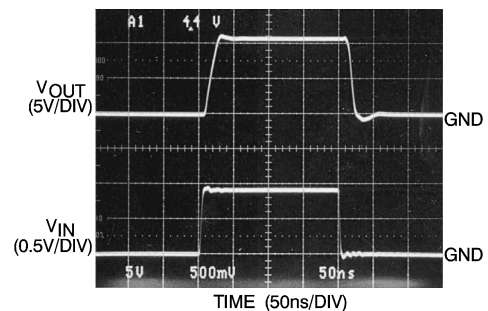
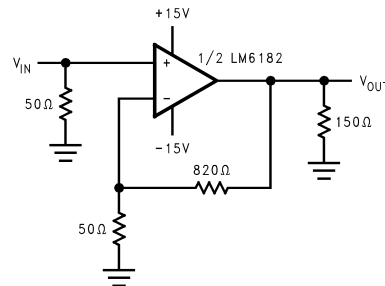

FIGURE 15. 15 ns Closed Loop Output Overdrive Recovery Time Generated by Saturating the Output Stage of the LM6182

Typical Applications (Continued)

The common-mode input range of a unity-gain circuit is exceeded by a 4V pulse resulting in a typical recovery time of 20 ns shown in Figure 16.

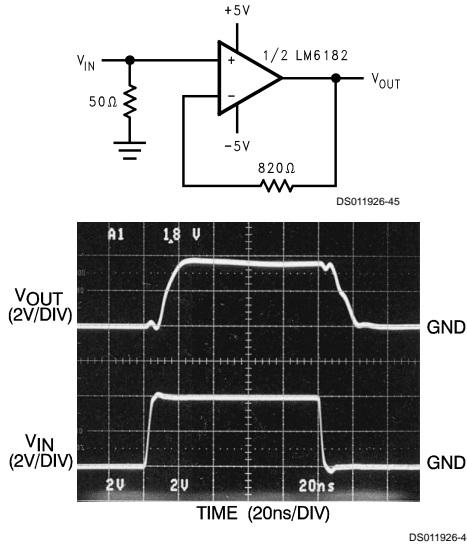

FIGURE 16. Output Recovery from an Input that Exceeds the Common-Mode Range

SPICE MACROMODEL

A spice macromodel is available for the LM6182. Contact your local National Semiconductor sales office to obtain an operational amplifier spice model library disk.

Typical Application Circuits

UNITY GAIN AMPLIFIER

The LM6182 current feedback amplifier is unity gain stable. The feedback resistor, R_f , is required to maintain the LM6182's dynamic performance.

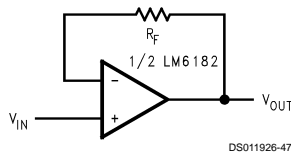

FIGURE 17. LM6182 Is Unity Gain Stable

NON-INVERTING GAIN AMPLIFIER

Current feedback amplifiers can be used in non-inverting gain and level shifting functions. The same basic closed-loop gain equation used for voltage feedback amplifiers applies to current feedback amplifiers: $1 + R_f/R_s$.

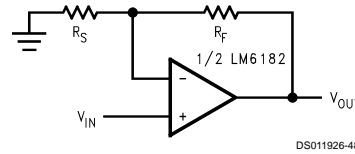

FIGURE 18. Non-Inverting Closed Loop Gain is Determined with the Same Equation Voltage Feedback Amplifiers Use: $1 + R_f/R_s$

INVERTING GAIN AMPLIFIER

The inverting closed loop gain equation used with voltage feedback amplifiers also applies to current feedback amplifiers.

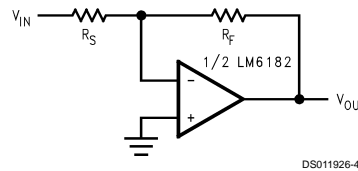

FIGURE 19. Current Feedback Amplifiers Can Be Used for Inverting Gains, Just Like a Voltage Feedback Amplifier: $-R_f/R_s$

SUMMING AMPLIFIER

The current feedback topology of the LM6182 provides significant performance advantages over a conventional voltage feedback amplifier used in a standard summing circuit. Using a voltage feedback amplifier, the bandwidth of the summing circuit in Figure 20 is limited by the highest gain needed for either signal V_1 or V_2 . If the LM6182 amplifier is used instead, wide circuit bandwidth can be maintained relatively independent of gain requirements.

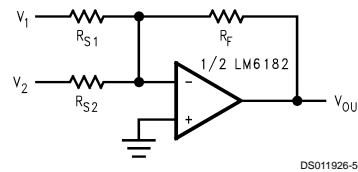

FIGURE 20. LM6182 Allows the Summing Circuit to Meet the Requirements of Wide Bandwidth Systems Independent of Signal Gain

Ordering Information

| Package | Temperature Range | | NSC Drawing |
|----------------------------|-----------------------------|---------------------------------|----------------|
| | Military -55°C to +125°C | Industrial -40°C to +85°C | |
| 8-pin Molded DIP | LM6182AMN | LM6182AIN LM6182IN | N08E |
| 16-pin Small Outline | | LM6182AIM LM6182IM | M16A |

If Military/Aerospace specified devices are required, contact the National Semiconductor Sales Office or Distributors for availability and specifications.

Physical Dimensions inches (millimeters) unless otherwise noted

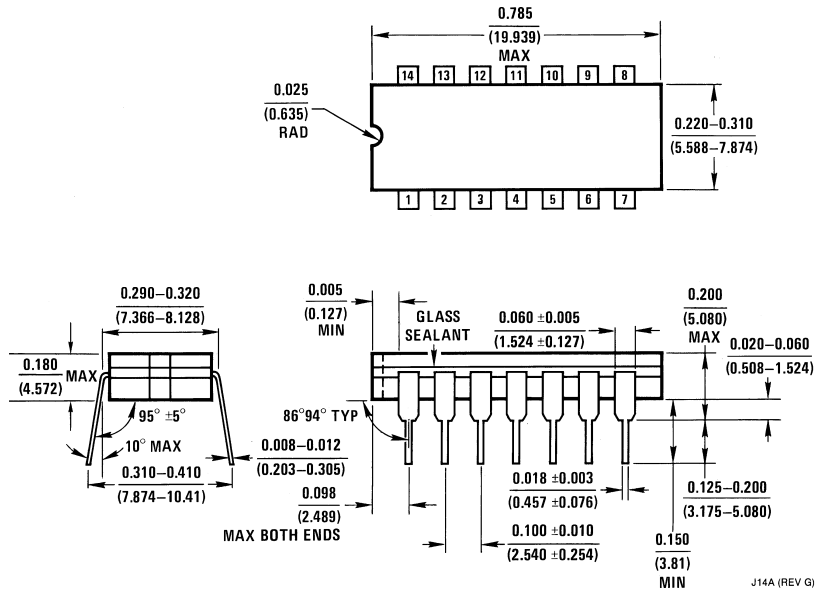

14-Lead Dual-In-Line Package (J)
Order Number LM6182AMJ/883
NS Package Number J14A

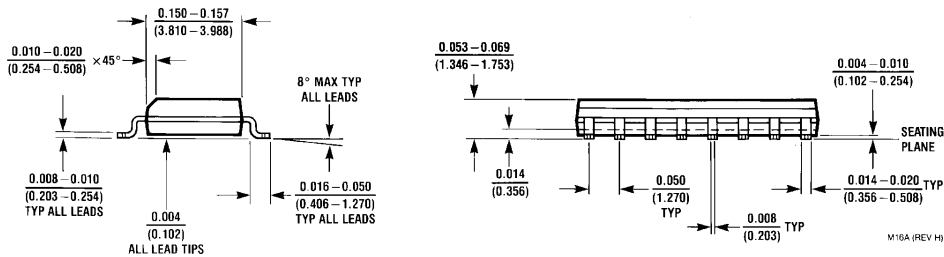
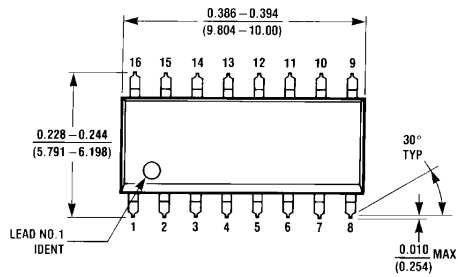

Small Outline Package (M)
Order Number LM6182IM or LM6182AIM
NS Package Number M16A

Physical Dimensions inches (millimeters) unless otherwise noted (Continued)

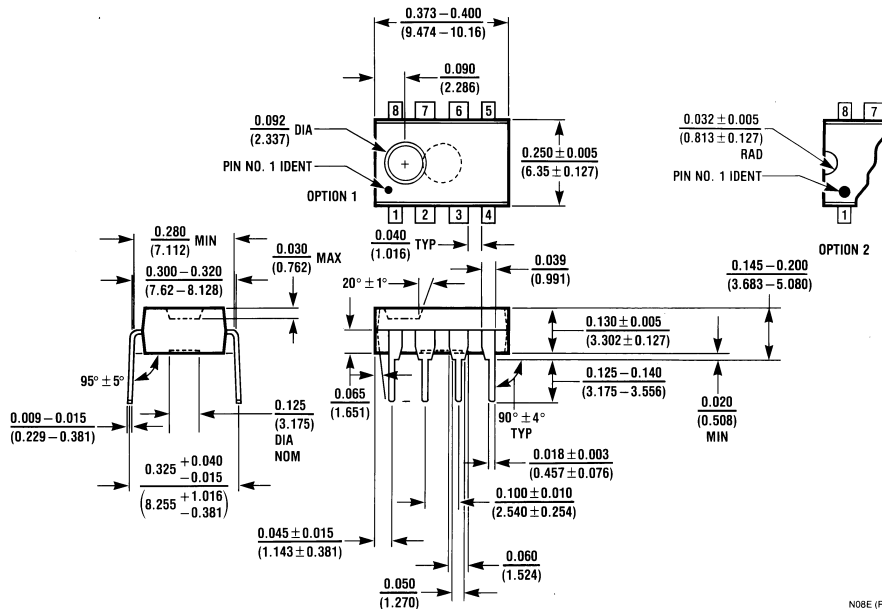

Dual-In-Line Package (N)
Order Number LM6182IN, LM6182AIN, or LM6182AMN
NS Package Number N08E

N08E (REV F)

LIFE SUPPORT POLICY

NATIONAL'S PRODUCTS ARE NOT AUTHORIZED FOR USE AS CRITICAL COMPONENTS IN LIFE SUPPORT DEVICES OR SYSTEMS WITHOUT THE EXPRESS WRITTEN APPROVAL OF THE PRESIDENT OF NATIONAL SEMICONDUCTOR CORPORATION. As used herein:

1. Life support devices or systems are devices or systems which, (a) are intended for surgical implant into the body, or (b) support or sustain life, and whose failure to perform when properly used in accordance with instructions for use provided in the labeling, can be reasonably expected to result in a significant injury to the user.
2. A critical component is any component of a life support device or system whose failure to perform can be reasonably expected to cause the failure of the life support device or system, or to affect its safety or effectiveness.



National Semiconductor Corporation
 Americas
 Tel: 1-800-272-9959
 Fax: 1-800-737-7018
 Email: support@nsc.com

National Semiconductor Europe
 Fax: +49 (0) 1 80-530 85 86
 Email: europe.support@nsc.com
 Deutsch Tel: +49 (0) 1 80-530 85 85
 English Tel: +49 (0) 1 80-532 78 32
 Français Tel: +49 (0) 1 80-532 93 58
 Italiano Tel: +49 (0) 1 80-534 16 80

National Semiconductor Asia Pacific Customer Response Group
 Tel: 65-2544466
 Fax: 65-2504466
 Email: sea.support@nsc.com

National Semiconductor Japan Ltd.
 Tel: 81-3-5639-7560
 Fax: 81-3-5639-7507

www.national.com