

## LMC6034 CMOS Quad Operational Amplifier

### General Description

The LMC6034 is a CMOS quad operational amplifier which can operate from either a single supply or dual supplies. Its performance features include an input common-mode range that reaches ground, low input bias current, and high voltage gain into realistic loads, such as 2 k $\Omega$  and 600 $\Omega$ .

This chip is built with National's advanced Double-Poly Silicon-Gate CMOS process.

See the LMC6032 datasheet for a CMOS dual operational amplifier with these same features. For higher performance characteristics refer to the LMC660.

### Features

- Specified for 2 k $\Omega$  and 600 $\Omega$  loads
- High voltage gain: 126 dB

- Low offset voltage drift: 2.3  $\mu\text{V}/^\circ\text{C}$
- Ultra low input bias current: 40 fA
- Input common-mode range includes  $V^-$
- Operating Range from +5V to +15V supply
- $I_{SS} = 400 \mu\text{A}/\text{amplifier}$ ; independent of  $V^+$
- Low distortion: 0.01% at 10 kHz
- Slew rate: 1.1 V/ $\mu\text{s}$
- Improved performance over TLC274

### Applications

- High-impedance buffer or preamplifier
- Current-to-voltage converter
- Long-term integrator
- Sample-and-hold circuit
- Medical instrumentation

### Connection Diagram

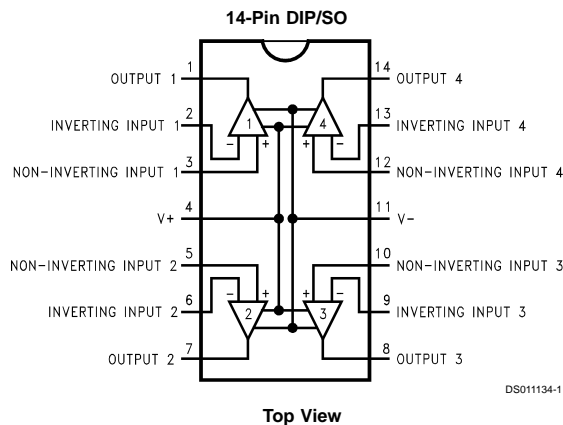

### Ordering Information

Temperature Range	Package	NSC Drawing	Transport Media
Industrial $-40^\circ\text{C} \leq T_J \leq +85^\circ\text{C}$			
LMC6034IN	14-Pin Molded DIP	N14A	Rail
LMC6034IM	14-Pin Small Outline	M14A	Rail Tape and Reel

## Absolute Maximum Ratings (Note 1)

If Military/Aerospace specified devices are required, please contact the National Semiconductor Sales Office/Distributors for availability and specifications.

Differential Input Voltage	±Supply Voltage
Supply Voltage ( $V^+ - V^-$ )	16V
Output Short Circuit to $V^+$	(Note 10)
Output Short Circuit to $V^-$	(Note 2)
Lead Temperature (Soldering, 10 sec.)	260°C
Storage Temperature Range	-65°C to +150°C
Power Dissipation	(Note 3)
Voltage at Output/Input Pin	( $V^+$ ) +0.3V, ( $V^-$ ) -0.3V
Current at Output Pin	±18 mA

Current at Input Pin	±5 mA
Current at Power Supply Pin	35 mA
Junction Temperature (Note 3)	150°C
ESD Tolerance (Note 4)	1000V

## Operating Ratings (Note 1)

Temperature Range	-40°C ≤ $T_J$ ≤ +85°C
Supply Voltage Range	4.75V to 15.5V
Power Dissipation	(Note 11)
Thermal Resistance ( $\theta_{JA}$ ), (Note 12)	
14-Pin DIP	85°C/W
14-Pin SO	115°C/W

## DC Electrical Characteristics

Unless otherwise specified, all limits guaranteed for  $T_J = 25^\circ\text{C}$ . **Boldface** limits apply at the temperature extremes.  $V^+ = 5\text{V}$ ,  $V^- = \text{GND} = 0\text{V}$ ,  $V_{CM} = 1.5\text{V}$ ,  $V_{OUT} = 2.5\text{V}$ , and  $R_L > 1\text{M}$  unless otherwise specified.

Symbol	Parameter	Conditions	Typical (Note 5)	LMC6034I Limit (Note 6)	Units
$V_{OS}$	Input Offset Voltage		1	9 <b>11</b>	mV max
$\Delta V_{OS}/\Delta T$	Input Offset Voltage Average Drift		2.3		$\mu\text{V}/^\circ\text{C}$
$I_B$	Input Bias Current		0.04	<b>200</b>	pA max
$I_{OS}$	Input Offset Current		0.01	<b>100</b>	pA max
$R_{IN}$	Input Resistance		>1		Tera $\Omega$
CMRR	Common Mode Rejection Ratio	$0\text{V} \leq V_{CM} \leq 12\text{V}$ $V^+ = 15\text{V}$	83	63 <b>60</b>	dB min
+PSRR	Positive Power Supply Rejection Ratio	$5\text{V} \leq V^+ \leq 15\text{V}$ $V_O = 2.5\text{V}$	83	63 <b>60</b>	dB min
-PSRR	Negative Power Supply Rejection Ratio	$0\text{V} \leq V^- \leq -10\text{V}$	94	74 <b>70</b>	dB min
$V_{CM}$	Input Common-Mode Voltage Range	$V^+ = 5\text{V} \ \& \ 15\text{V}$ For CMRR ≥ 50 dB	-0.4  $V^+ - 1.9$	-0.1  <b>0</b>  $V^+ - 2.3$ <b><math>V^+ - 2.6</math></b>	V max  V min
$A_V$	Large Signal Voltage Gain	$R_L = 2 \text{ k}\Omega$ (Note 7) Sourcing Sinking  $R_L = 600\Omega$ (Note 7) Sourcing Sinking	2000  500  1000  250	200  <b>100</b>  90  <b>40</b>  100  <b>75</b>  50  <b>20</b>	V/mV min  V/mV min  V/mV min  V/mV min

## DC Electrical Characteristics (Continued)

Unless otherwise specified, all limits guaranteed for  $T_J = 25^\circ\text{C}$ . **Boldface** limits apply at the temperature extremes.  $V^+ = 5\text{V}$ ,  $V^- = \text{GND} = 0\text{V}$ ,  $V_{\text{CM}} = 1.5\text{V}$ ,  $V_{\text{OUT}} = 2.5\text{V}$ , and  $R_L > 1\text{M}$  unless otherwise specified.

Symbol	Parameter	Conditions	Typical (Note 5)	LMC6034I Limit (Note 6)	Units		
$V_O$	Output Voltage Swing	$V^+ = 5\text{V}$ $R_L = 2\text{ k}\Omega$ to $2.5\text{V}$	4.87	4.20 <b>4.00</b>	V min		
			0.10	0.25 <b>0.35</b>	V max		
		$V^+ = 5\text{V}$ $R_L = 600\Omega$ to $2.5\text{V}$	4.61	4.00 <b>3.80</b>	V min		
			0.30	0.63 <b>0.75</b>	V max		
		$V^+ = 15\text{V}$ $R_L = 2\text{ k}\Omega$ to $7.5\text{V}$	14.63	13.50 <b>13.00</b>	V min		
			0.26	0.45 <b>0.55</b>	V max		
		$V^+ = 15\text{V}$ $R_L = 600\Omega$ to $7.5\text{V}$	13.90	12.50 <b>12.00</b>	V min		
			0.79	1.45 <b>1.75</b>	V max		
		$I_O$	Output Current	$V^+ = 5\text{V}$ Sourcing, $V_O = 0\text{V}$ Sinking, $V_O = 5\text{V}$	22	13 <b>9</b>	mA min
					21	13 <b>9</b>	mA min
$V^+ = 15\text{V}$ Sourcing, $V_O = 0\text{V}$ Sinking, $V_O = 13\text{V}$ (Note 10)	40			23 <b>15</b>	mA min		
	39			23 <b>15</b>	mA min		
Supply Current	All Four Amplifiers $V_O = 1.5\text{V}$			1.5	2.7 <b>3.0</b>	mA max	

## AC Electrical Characteristics

Unless otherwise specified, all limits guaranteed for  $T_J = 25^\circ\text{C}$ . **Boldface** limits apply at the temperature extremes.  $V^+ = 5\text{V}$ ,  $V^- = \text{GND} = 0\text{V}$ ,  $V_{\text{CM}} = 1.5\text{V}$ ,  $V_{\text{OUT}} = 2.5\text{V}$ , and  $R_L > 1\text{M}$  unless otherwise specified.

Symbol	Parameter	Conditions	Typical (Note 5)	LMC6034I Limit (Note 6)	Units
SR	Slew Rate	(Note 8)	1.1	0.8 <b>0.4</b>	V/ $\mu\text{s}$ min
GBW	Gain-Bandwidth Product		1.4		MHz
$\phi_M$	Phase Margin		50		Deg
$G_M$	Gain Margin		17		dB
	Amp-to-Amp Isolation	(Note 9)	130		dB
$e_n$	Input-Referred Voltage Noise	$F = 1\text{ kHz}$	22		$\text{nV}/\sqrt{\text{Hz}}$
$i_n$	Input-Referred Current Noise	$F = 1\text{ kHz}$	0.0002		$\text{pA}/\sqrt{\text{Hz}}$
THD	Total Harmonic Distortion	$F = 10\text{ kHz}$ , $A_V = -10$ $R_L = 2\text{ k}\Omega$ , $V_O = 8\text{ V}_{\text{PP}}$ $\pm 5\text{V}$ Supply	0.01		%

**Note 1:** Absolute Maximum Ratings indicate limits beyond which damage to the component may occur. Operating Ratings indicate conditions for which the device is intended to be functional, but do not guarantee specific performance limits. For guaranteed specifications and test conditions, see the Electrical Characteristics. The guaranteed specifications apply only for the test conditions listed.

**Note 2:** Applies to both single-supply and split-supply operation. Continuous short circuit operation at elevated ambient temperature and/or multiple Op Amp shorts can result in exceeding the maximum allowed junction temperature of  $150^\circ\text{C}$ . Output currents in excess of  $\pm 30\text{ mA}$  over long term may adversely affect reliability.

**Note 3:** The maximum power dissipation is a function of  $T_{\text{J(max)}}$ ,  $\theta_{\text{JA}}$ ,  $T_{\text{A}}$ . The maximum allowable power dissipation at any ambient temperature is  $P_D = (T_{\text{J(max)}} - T_{\text{A}}) / \theta_{\text{JA}}$ .

**Note 4:** Human body model,  $100\text{ pF}$  discharged through a  $1.5\text{ k}\Omega$  resistor.

**Note 5:** Typical values represent the most likely parametric norm.

**Note 6:** All limits are guaranteed at room temperature (standard type face) or at operating temperature extremes (**bold type face**).

**Note 7:**  $V^+ = 15\text{V}$ ,  $V_{\text{CM}} = 7.5\text{V}$ , and  $R_L$  connected to  $7.5\text{V}$ . For Sourcing tests,  $7.5\text{V} \leq V_O \leq 11.5\text{V}$ . For Sinking tests,  $2.5\text{V} \leq V_O \leq 7.5\text{V}$ .

**Note 8:**  $V^+ = 15\text{V}$ . Connected as Voltage Follower with  $10\text{V}$  step input. Number specified is the slower of the positive and negative slew rates.

**Note 9:** Input referred.  $V^+ = 15\text{V}$  and  $R_L = 10\text{ k}\Omega$  connected to  $V^+/2$ . Each amp excited in turn with  $1\text{ kHz}$  to produce  $V_O = 13\text{ V}_{\text{PP}}$ .

**Note 10:** Do not connect output to  $V^+$ , when  $V^+$  is greater than  $13\text{V}$  or reliability may be adversely affected.

**Note 11:** For operating at elevated temperatures the device must be derated based on the thermal resistance  $\theta_{\text{JA}}$  with  $P_D = (T_J - T_A) / \theta_{\text{JA}}$ .

**Note 12:** All numbers apply for packages soldered directly into a PC board.

## Typical Performance Characteristics $V_S = \pm 7.5\text{V}$ , $T_A = 25^\circ\text{C}$ unless otherwise specified

**Supply Current vs Supply Voltage**

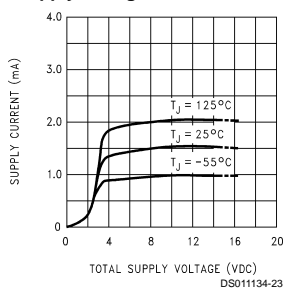

**Input Bias Current**

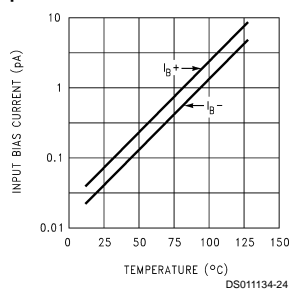

**Output Characteristics Current Sinking**

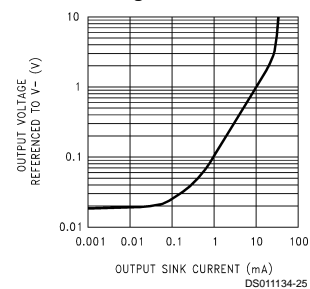

## Typical Performance Characteristics $V_S = \pm 7.5V$ , $T_A = 25^\circ C$ unless otherwise specified (Continued)

**Output Characteristics  
Current Sourcing**

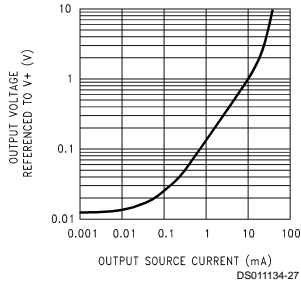

**Input Voltage Noise  
vs Frequency**

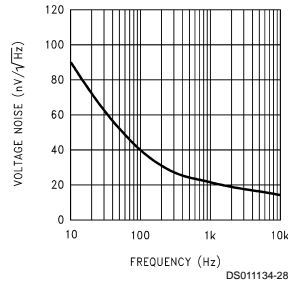

**CMRR vs Frequency**

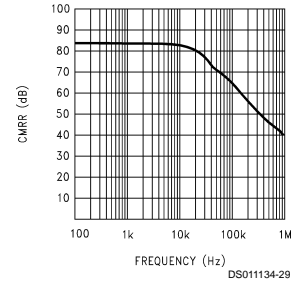

**Open-Loop Frequency  
Response**

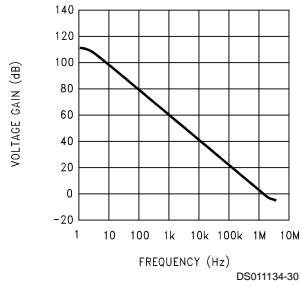

**Frequency Response  
vs Capacitive Load**

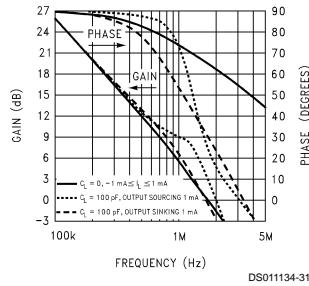

**Non-Inverting Large Signal  
Pulse Response**

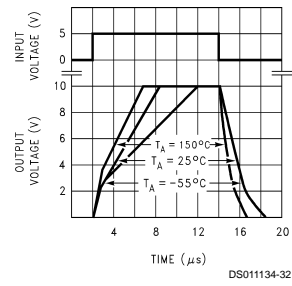

**Stability vs  
Capacitive Load**

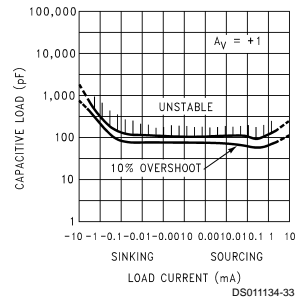

**Stability vs  
Capacitive Load**

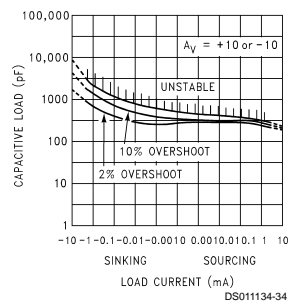

**Note:** Avoid resistive loads of less than  $500\Omega$ , as they may cause instability.

## Applications Hint

### Amplifier Topology

The topology chosen for the LMC6034, shown in Figure 1, is unconventional (compared to general-purpose op amps) in that the traditional unity-gain buffer output stage is not used; instead, the output is taken directly from the output of the integrator, to allow a larger output swing. Since the buffer traditionally delivers the power to the load, while maintaining high op amp gain and stability, and must withstand shorts to either rail, these tasks now fall to the integrator.

As a result of these demands, the integrator is a compound affair with an embedded gain stage that is doubly fed forward (via  $C_f$  and  $C_{ff}$ ) by a dedicated unity-gain compensation driver. In addition, the output portion of the integrator is a push-pull configuration for delivering heavy loads. While sinking current the whole amplifier path consists of three gain stages with one stage fed forward, whereas while sourcing the path contains four gain stages with two fed forward.

## Applications Hint (Continued)

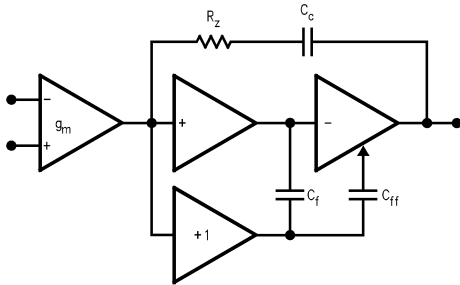

DS011134-3

**FIGURE 1. LMC6034 Circuit Topology (Each Amplifier)**

The large signal voltage gain while sourcing is comparable to traditional bipolar op amps, even with a 600Ω load. The gain while sinking is higher than most CMOS op amps, due to the additional gain stage; however, under heavy load (600Ω) the gain will be reduced as indicated in the Electrical Characteristics.

### Compensating Input Capacitance

The high input resistance of the LMC6034 op amps allows the use of large feedback and source resistor values without losing gain accuracy due to loading. However, the circuit will be especially sensitive to its layout when these large-value resistors are used.

Every amplifier has some capacitance between each input and AC ground, and also some differential capacitance between the inputs. When the feedback network around an amplifier is resistive, this input capacitance (along with any additional capacitance due to circuit board traces, the socket, etc.) and the feedback network create a pole in the feedback path. In the following General Operational Amplifier circuit, *Figure 2* the frequency of this pole is

$$f_p = \frac{1}{2\pi C_S R_P}$$

where  $C_S$  is the total capacitance at the inverting input, including amplifier input capacitance and any stray capacitance from the IC socket (if one is used), circuit board traces, etc., and  $R_P$  is the parallel combination of  $R_F$  and  $R_{IN}$ . This formula, as well as all formulae derived below, apply to inverting and non-inverting op-amp configurations.

When the feedback resistors are smaller than a few kΩ, the frequency of the feedback pole will be quite high, since  $C_S$  is generally less than 10 pF. If the frequency of the feedback pole is much higher than the "ideal" closed-loop bandwidth (the nominal closed-loop bandwidth in the absence of  $C_S$ ), the pole will have a negligible effect on stability, as it will add only a small amount of phase shift.

However, if the feedback pole is less than approximately 6 to 10 times the "ideal" -3 dB frequency, a feedback capacitor,  $C_F$ , should be connected between the output and the inverting input of the op amp. This condition can also be stated in terms of the amplifier's low-frequency noise gain: To maintain stability a feedback capacitor will probably be needed if

$$\left(\frac{R_F}{R_{IN}} + 1\right) \leq \sqrt{6 \times 2\pi \times \text{GBW} \times R_F \times C_S}$$

where

$$\left(\frac{R_F}{R_{IN}} + 1\right)$$

is the amplifier's low-frequency noise gain and GBW is the amplifier's gain bandwidth product. An amplifier's low-frequency noise gain is represented by the formula

$$\left(\frac{R_F}{R_{IN}} + 1\right)$$

regardless of whether the amplifier is being used in inverting or non-inverting mode. Note that a feedback capacitor is more likely to be needed when the noise gain is low and/or the feedback resistor is large.

If the above condition is met (indicating a feedback capacitor will probably be needed), and the noise gain is large enough that:

$$\left(\frac{R_F}{R_{IN}} + 1\right) \geq 2\sqrt{\text{GBW} \times R_F \times C_S},$$

the following value of feedback capacitor is recommended:

$$C_F = \frac{C_S}{2\left(\frac{R_F}{R_{IN}} + 1\right)}$$

If

$$\left(\frac{R_F}{R_{IN}} + 1\right) < 2\sqrt{\text{GBW} \times R_F \times C_S}$$

the feedback capacitor should be:

$$C_F = \sqrt{\frac{C_S}{\text{GBW} \times R_F}}$$

Note that these capacitor values are usually significantly smaller than those given by the older, more conservative formula:

$$C_F = \frac{C_S R_{IN}}{R_F}$$

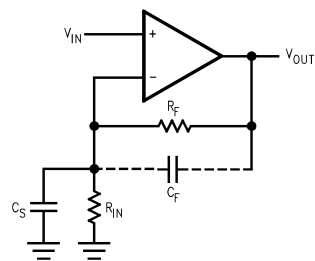

DS011134-4

$C_S$  consists of the amplifier's input capacitance plus any stray capacitance from the circuit board and socket.  $C_F$  compensates for the pole caused by  $C_S$  and the feedback resistors.

**FIGURE 2. General Operational Amplifier Circuit**

Using the smaller capacitors will give much higher bandwidth with little degradation of transient response. It may be necessary in any of the above cases to use a somewhat larger feedback capacitor to allow for unexpected stray ca-

## Applications Hint (Continued)

capacitance, or to tolerate additional phase shifts in the loop, or excessive capacitive load, or to decrease the noise or bandwidth, or simply because the particular circuit implementation needs more feedback capacitance to be sufficiently stable. For example, a printed circuit board's stray capacitance may be larger or smaller than the breadboard's, so the actual optimum value for  $C_F$  may be different from the one estimated using the breadboard. In most cases, the values of  $C_F$  should be checked on the actual circuit, starting with the computed value.

### Capacitive Load Tolerance

Like many other op amps, the LMC6034 may oscillate when its applied load appears capacitive. The threshold of oscillation varies both with load and circuit gain. The configuration most sensitive to oscillation is a unity-gain follower. See Typical Performance Characteristics.

The load capacitance interacts with the op amp's output resistance to create an additional pole. If this pole frequency is sufficiently low, it will degrade the op amp's phase margin so that the amplifier is no longer stable at low gains. As shown in *Figure 3*, the addition of a small resistor ( $50\Omega$  to  $100\Omega$ ) in series with the op amp's output, and a capacitor ( $5\text{ pF}$  to  $10\text{ pF}$ ) from inverting input to output pins, returns the phase margin to a safe value without interfering with lower-frequency circuit operation. Thus larger values of capacitance can be tolerated without oscillation. Note that in all cases, the output will ring heavily when the load capacitance is near the threshold for oscillation.

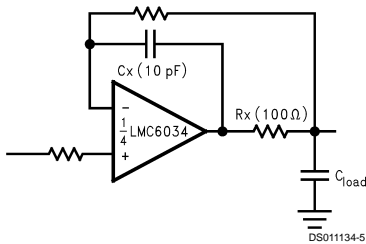

FIGURE 3. Rx, Cx Improve Capacitive Load Tolerance

Capacitive load driving capability is enhanced by using a pull up resistor to  $V^+$  (*Figure 4*). Typically a pull up resistor conducting  $500\text{ }\mu\text{A}$  or more will significantly improve capacitive load responses. The value of the pull up resistor must be determined based on the current sinking capability of the amplifier with respect to the desired output swing. Open loop gain of the amplifier can also be affected by the pull up resistor (see Electrical Characteristics).

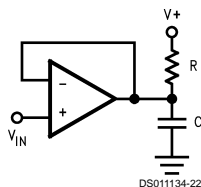

FIGURE 4. Compensating for Large Capacitive Loads with a Pull Up Resistor

## PRINTED-CIRCUIT-BOARD LAYOUT FOR HIGH-IMPEDANCE WORK

It is generally recognized that any circuit which must operate with less than  $1000\text{ pA}$  of leakage current requires special layout of the PC board. When one wishes to take advantage of the ultra-low bias current of the LMC6034, typically less than  $0.04\text{ pA}$ , it is essential to have an excellent layout. Fortunately, the techniques for obtaining low leakages are quite simple. First, the user must not ignore the surface leakage of the PC board, even though it may sometimes appear acceptably low, because under conditions of high humidity or dust or contamination, the surface leakage will be appreciable.

To minimize the effect of any surface leakage, lay out a ring of foil completely surrounding the LMC6034's inputs and the terminals of capacitors, diodes, conductors, resistors, relay terminals, etc. connected to the op-amp's inputs. See *Figure 5*. To have a significant effect, guard rings should be placed on both the top and bottom of the PC board. This PC foil must then be connected to a voltage which is at the same voltage as the amplifier inputs, since no leakage current can flow between two points at the same potential. For example, a PC board trace-to-pad resistance of  $10^{12}\Omega$ , which is normally considered a very large resistance, could leak  $5\text{ pA}$  if the trace were a  $5\text{ V}$  bus adjacent to the pad of an input. This would cause a 100 times degradation from the LMC6034's actual performance. However, if a guard ring is held within  $5\text{ mV}$  of the inputs, then even a resistance of  $10^{11}\Omega$  would cause only  $0.05\text{ pA}$  of leakage current, or perhaps a minor (2:1) degradation of the amplifier's performance. See *Figures 6, 7, 8* for typical connections of guard rings for standard op-amp configurations. If both inputs are active and at high impedance, the guard can be tied to ground and still provide some protection; see *Figure 9*.

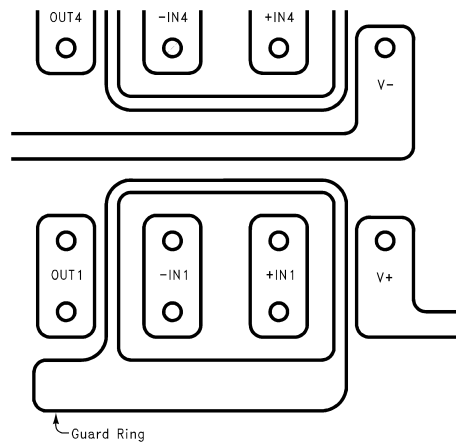
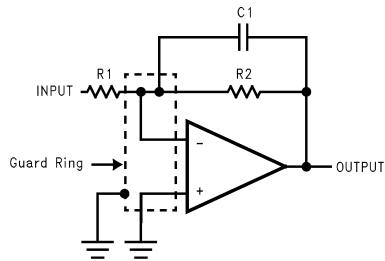

FIGURE 5. Example of Guard Ring in P.C. Board Layout

## Applications Hint (Continued)



DS011134-7

**FIGURE 6. Guard Ring Connections Inverting Amplifier**

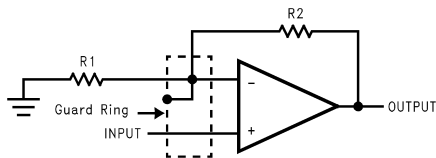

DS011134-8

**FIGURE 7. Guard Ring Connections Non-Inverting Amplifier**

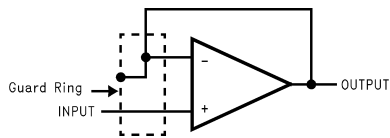

DS011134-9

**FIGURE 8. Guard Ring Connections Follower**

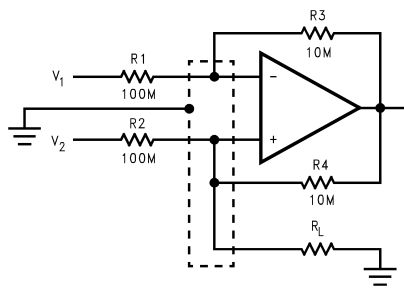

DS011134-10

**FIGURE 9. Guard Ring Connections Howland Current Pump**

The designer should be aware that when it is inappropriate to lay out a PC board for the sake of just a few circuits, there is another technique which is even better than a guard ring on a PC board: Don't insert the amplifier's input pin into the

board at all, but bend it up in the air and use only air as an insulator. Air is an excellent insulator. In this case you may have to forego some of the advantages of PC board construction, but the advantages are sometimes well worth the effort of using point-to-point up-in-the-air wiring. See Figure 10.

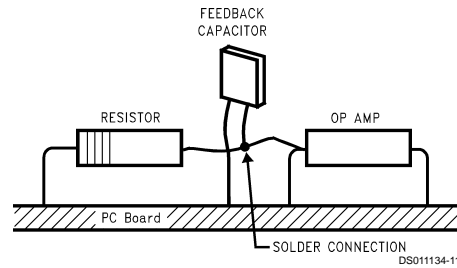

DS011134-11

(Input pins are lifted out of PC board and soldered directly to components. All other pins connected to PC board.)

**FIGURE 10. Air Wiring**

### BIAS CURRENT TESTING

The test method of Figure 11 is appropriate for bench-testing bias current with reasonable accuracy. To understand its operation, first close switch S2 momentarily. When S2 is opened, then

$$I_{b-} = \frac{dV_{OUT}}{dt} \times C_2.$$

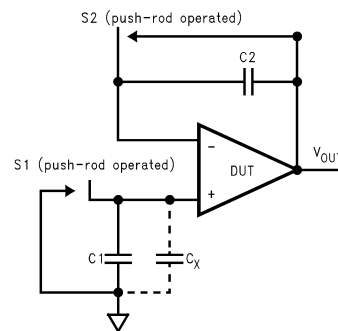

DS011134-12

**FIGURE 11. Simple Input Bias Current Test Circuit**

A suitable capacitor for C2 would be a 5 pF or 10 pF silver mica, NPO ceramic, or air-dielectric. When determining the magnitude of  $I_{b-}$ , the leakage of the capacitor and socket must be taken into account. Switch S2 should be left shorted most of the time, or else the dielectric absorption of the capacitor C2 could cause errors.

Similarly, if S1 is shorted momentarily (while leaving S2 shorted)

$$I_{b+} = \frac{dV_{OUT}}{dt} \times (C_1 + C_x)$$

where  $C_x$  is the stray capacitance at the + input.



## Typical Single-Supply Applications (V\* = 5.0 VDC)

Additional single-supply applications ideas can be found in the LM324 datasheet. The LMC6034 is pin-for-pin compatible with the LM324 and offers greater bandwidth and input resistance over the LM324. These features will improve the performance of many existing single-supply applications. Note, however, that the supply voltage range of the LMC6034 is smaller than that of the LM324.

### Low-Leakage Sample-and-Hold

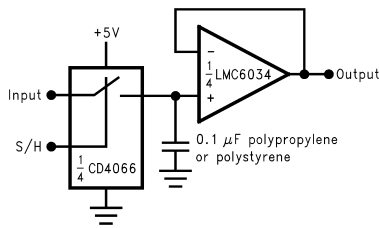

DS011134-13

### Instrumentation Amplifier

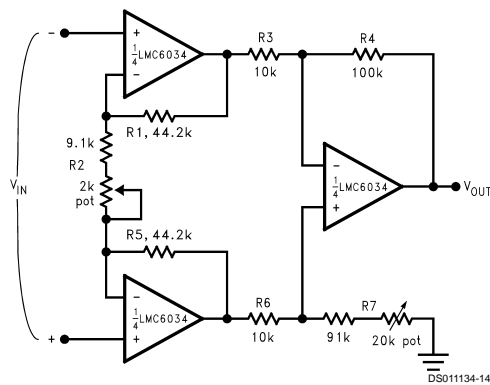

DS011134-14

$$\frac{V_{OUT}}{V_{IN}} = \frac{R_2 + 2R_1}{R_2} \times \frac{R_4}{R_3}$$

if  $R_1 = R_5$

$R_3 = R_6$ .

and  $R_4 = R_7$ .

$$\frac{V_{OUT}}{V_{IN}} = 100 \text{ for circuit as shown.}$$

For good CMRR over temperature, low drift resistors should be used. Matching of  $R_3$  to  $R_6$  and  $R_4$  to  $R_7$  affect CMRR. Gain may be adjusted through  $R_2$ . CMRR may be adjusted through  $R_7$ .

### Sine-Wave Oscillator

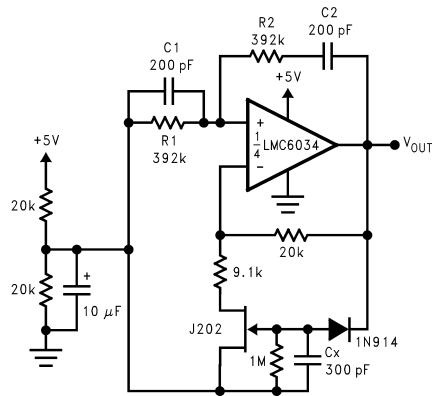

DS011134-15

Oscillator frequency is determined by  $R_1$ ,  $R_2$ ,  $C_1$ , and  $C_2$ :

$$f_{osc} = 1/2\pi RC, \text{ where } R = R_1 = R_2 \text{ and}$$

$$C = C_1 = C_2.$$

This circuit, as shown, oscillates at 2.0 kHz with a peak-to-peak output swing of 4.0V.

### 1 Hz Square-Wave Oscillator

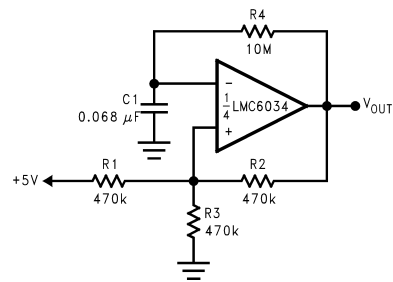

DS011134-16

### Power Amplifier

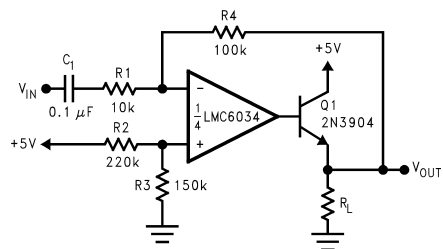

DS011134-17

## Typical Single-Supply Applications

( $V^+ = 5.0$  VDC) (Continued)

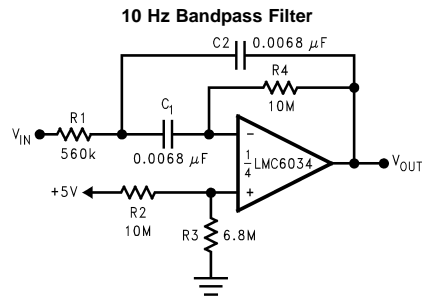

$f_c = 10$  Hz  
 $Q = 2.1$   
 Gain =  $-8.8$

DS011134-18

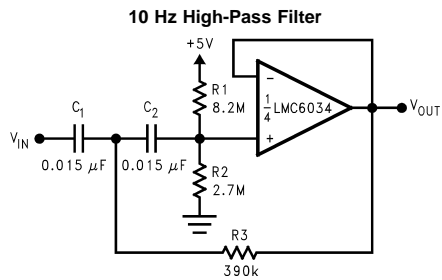

$f_c = 10$  Hz  
 $d = 0.895$   
 Gain = 1  
 2 dB passband ripple

DS011134-20

**1 Hz Low-Pass Filter  
 (Maximally Flat, Dual Supply Only)**

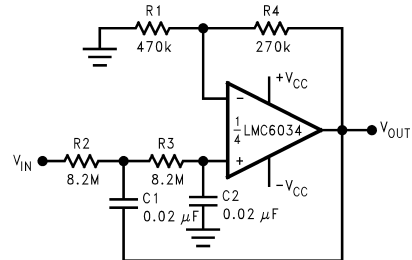

DS011134-19

$f_c = 1$  Hz  
 $d = 1.414$   
 Gain = 1.57

**High Gain Amplifier with Offset  
 Voltage Reduction**

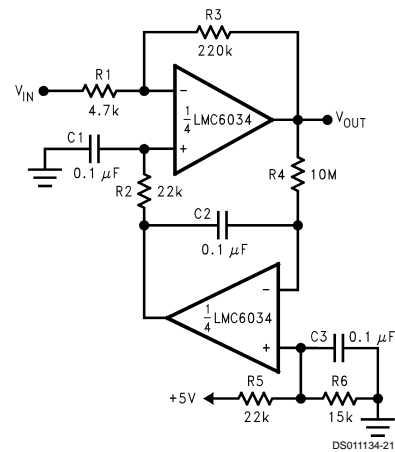

DS011134-21

Gain =  $-46.8$   
 Output offset  
 voltage reduced  
 to the level of  
 the input offset  
 voltage of the  
 bottom amplifier  
 (typically 1 mV).

**Physical Dimensions** inches (millimeters) unless otherwise noted

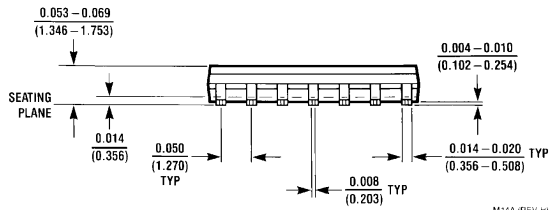
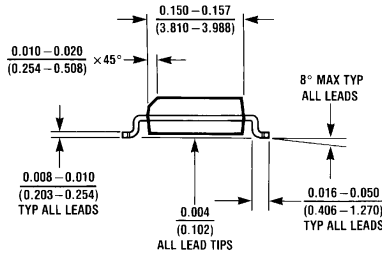
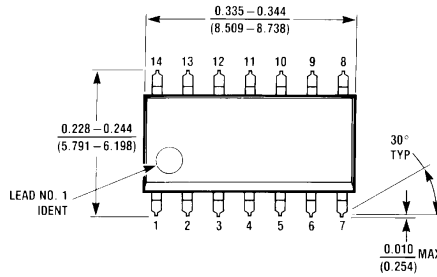

M14A (REV H)

**Small Outline Dual-In-Line Pkg. (M)**  
**Order Number LMC6034IM**  
**NS Package Number M14A**

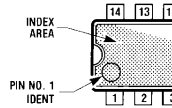
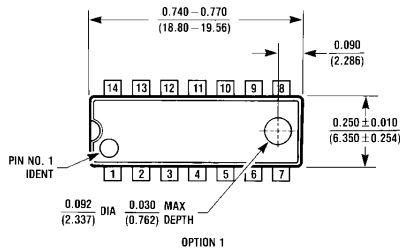

OPTION 1

OPTION 02

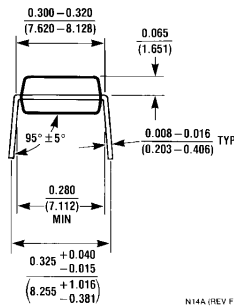
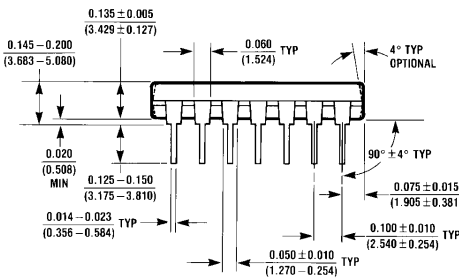

N14A (REV F)

**Molded Dual-In-Line Pkg. (N)**  
**Order Number LMC6034IN**  
**NS Package Number N14A**

## Notes

**LIFE SUPPORT POLICY**

NATIONAL'S PRODUCTS ARE NOT AUTHORIZED FOR USE AS CRITICAL COMPONENTS IN LIFE SUPPORT DEVICES OR SYSTEMS WITHOUT THE EXPRESS WRITTEN APPROVAL OF THE PRESIDENT OF NATIONAL SEMICONDUCTOR CORPORATION. As used herein:

1. Life support devices or systems are devices or systems which, (a) are intended for surgical implant into the body, or (b) support or sustain life, and whose failure to perform when properly used in accordance with instructions for use provided in the labeling, can be reasonably expected to result in a significant injury to the user.
2. A critical component is any component of a life support device or system whose failure to perform can be reasonably expected to cause the failure of the life support device or system, or to affect its safety or effectiveness.



**National Semiconductor Corporation**  
Americas  
Tel: 1-800-272-9959  
Fax: 1-800-737-7018  
Email: support@nsc.com

www.national.com

**National Semiconductor Europe**

Fax: +49 (0) 1 80-530 85 86  
Email: europe.support@nsc.com  
Deutsch Tel: +49 (0) 1 80-530 85 85  
English Tel: +49 (0) 1 80-532 78 32  
Français Tel: +49 (0) 1 80-532 93 58  
Italiano Tel: +49 (0) 1 80-534 16 80

**National Semiconductor Asia Pacific Customer Response Group**

Tel: 65-2544466  
Fax: 65-2504466  
Email: sea.support@nsc.com

**National Semiconductor Japan Ltd.**

Tel: 81-3-5639-7560  
Fax: 81-3-5639-7507