

LP311 Voltage Comparator

General Description

The LP311 is a low power version of the industry-standard LM311. It takes advantage of stable high-value ion-implanted resistors to perform the same function as an LM311, with a 30:1 reduction in power drain, but only a 6:1 slowdown of response time. Thus the LP311 is well suited for battery-powered applications, and all other applications where fast response is not needed. It operates over a wide range of supply voltages from 36V down to a single 3V supply, with less than 200 μ A drain, but it is still capable of driving a 25 mA load. The LP311 is quite easy to apply without any oscillation, if ordinary precautions are taken to minimize stray coupling from the output to either input or to the balance pins (as described in the LM311 datasheet Application Hints).

Features

- Low power drain, 900 μ W on 5V supply
- Operates from ± 15 V or a single supply as low as 3V
- Output can drive 25 mA
- Emitter output can swing below negative supply
- Response time: 1.2 μ s
- Same pin-out as LM311
- Low input currents: 2 nA of offset, 15 nA of bias
- Large common-mode input range: -14.6 V to 13.6V with ± 15 V supply

Applications

- Level-detector for battery-powered instruments
- Low-power lamp or relay driver
- Low-power zero-crossing detector

Schematic Diagram

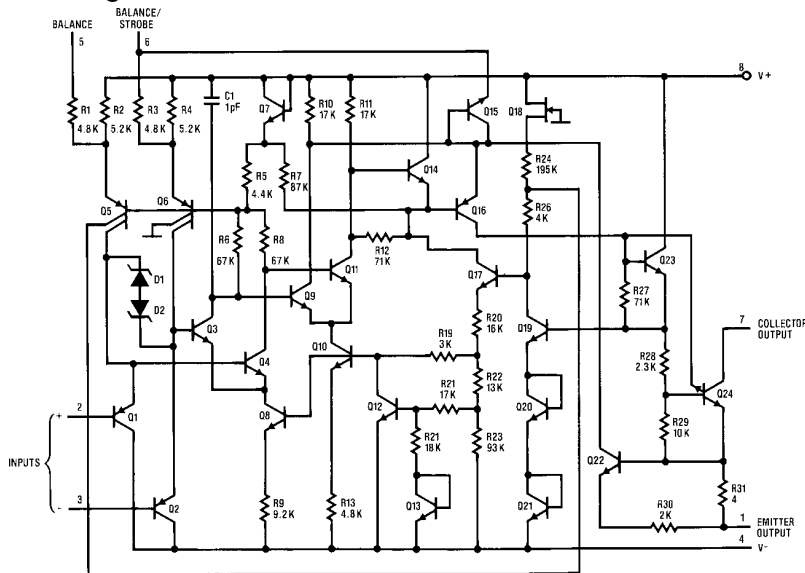

TL/H/5711-7

Connection Diagram

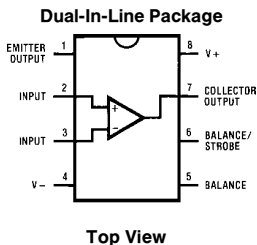

TL/H/5711-4

Order Number LP311M or LP311N
See NS Package Numbers M08A or N08E

Absolute Maximum Ratings

If Military/Aerospace specified devices are required, please contact the National Semiconductor Sales Office/Distributors for availability and specifications.

Total Supply Voltage (V_{8-4})	36V
Collector Output to Negative Supply Voltage (V_{7-4})	40V
Collector Output to Emitter Output	40V
Emitter Output to Negative Supply Voltage (V_{1-4})	±30V
Differential Input Voltage	±30V
Input Voltage (Note 1)	±15V

Power Dissipation (Note 2)	500 mW
Output Short Circuit Duration	10 sec
Operating Temperature Range	0°C to 70°C
Storage Temperature Range	-65°C to 150°C
Lead Temperature (Soldering, 10 seconds)	260°C

Electrical Characteristics

These specifications apply for $V_S = \pm 15V$ and $0^\circ C \leq T_A \leq 70^\circ C$, unless otherwise specified.

Parameter	Conditions	Min	Typ	Max	Units
Input Offset Voltage (Notes 3, 4)	$T_A = 25^\circ C, R_S \leq 100k$		2.0	7.5	mV
Input Offset Current (Notes 3, 4)	$T_A = 25^\circ C$		2.0	25	nA
Input Bias Current (Note 3)	$T_A = 25^\circ C$		15	100	nA
Voltage Gain	$T_A = 25^\circ C, R_L = 5k$	40	200		V/mV
Response Time (Note 5)	$T_A = 25^\circ C$		1.2		μs
Saturation Voltage (Note 6)	$V_{IN} \leq -10 mV, I_{OUT} = 25 mA$ $T_A = 25^\circ C$		0.4	1.5	V
Strobe Current (Note 7)	$T_A = 25^\circ C$	100	200	300	μA
Output Leakage Current	$V_{IN} \geq 10 mV, V_{OUT} = 35V$ $T_A = 25^\circ C$		0.2	100	nA
Input Offset Voltage (Notes 3, 4)	$R_S \leq 100k$			10	mV
Input Offset Current (Notes 3, 4)				35	nA
Input Bias Current (Note 3)				150	nA
Input Voltage Range		$V^- + 0.5$	$+13.7, -14.7$	$V^+ - 1.5$	V
Saturation Voltage (Note 6)	$V^+ \geq 4.5V, V^- = 0V$ $V_{IN} \leq -10 mV, I_{SINK} \leq 1.6 mA$		0.1	0.4	V
Positive Supply Current	$T_A = 25^\circ C, \text{Output on}$		150	300	μA
Negative Supply Current	$T_A = 25^\circ C$		80	180	μA
Minimum Operating Voltage	$T_A = 25^\circ C$		3.0	3.5	V

Note 1: This rating applies for $\pm 15V$ supplies. The positive input voltage limit is 30V above the negative supply. The negative input voltage limit is equal to the negative supply voltage or 30V below the positive supply, whichever is less.

Note 2: The maximum junction temperature of the LP311 is 85°C. For operating at elevated temperatures, devices in the dual-in-line package must be derated based on a thermal resistance of 160°C/W, junction to ambient.

Note 3: The offset voltage, offset current and bias current specifications apply for any supply voltage from a single 4V supply up to $\pm 15V$ supplies.

Note 4: The offset voltages and offset currents given are the maximum values required to drive the output within a volt of either supply with 1 mA load. Thus, these parameters define an error band and take into account the worst-case effects of voltage gain and input impedance.

Note 5: The response time specified is for a 100 mV input step with 5 mV overdrive.

Note 6: Saturation voltage specification applies to collector-emitter voltage (V_{7-1}) for $V_{COLLECTOR} \leq (V^+ - 3V)$.

Note 7: This specification gives the range of current which must be drawn from the strobe pin to ensure the output is properly disabled. Do not short the strobe pin to ground. It should be current driven, 100 μA to 300 μA .

Typical Performance Characteristics

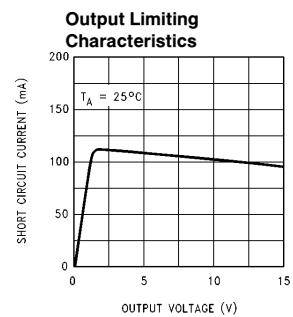
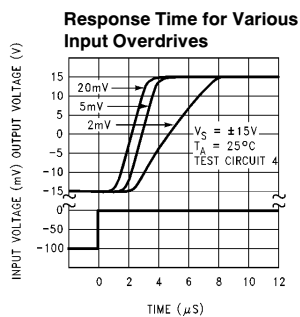
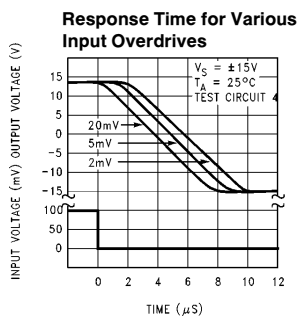
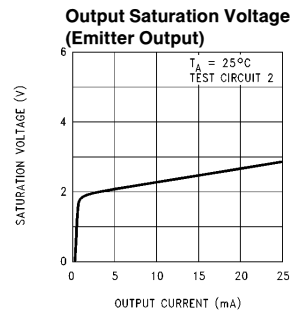
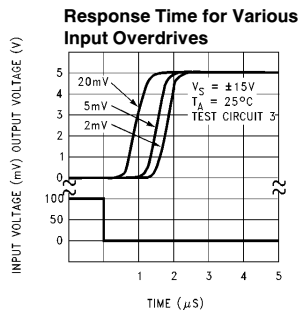
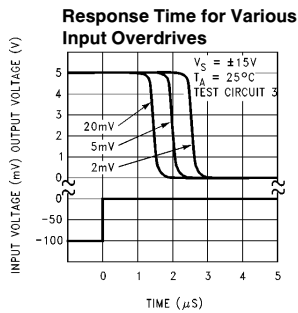
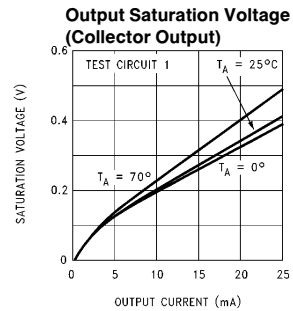
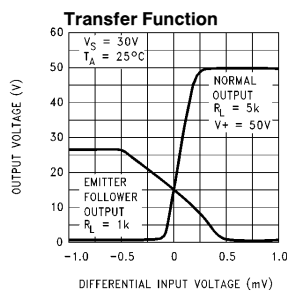
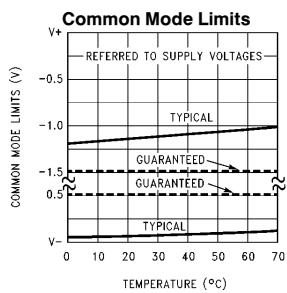
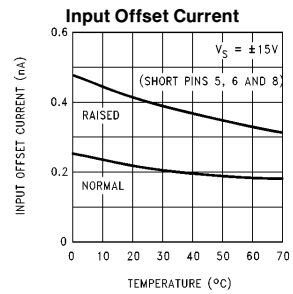
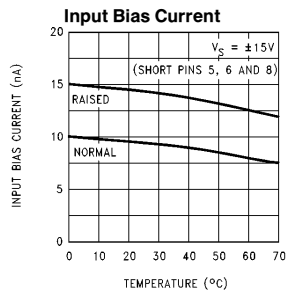
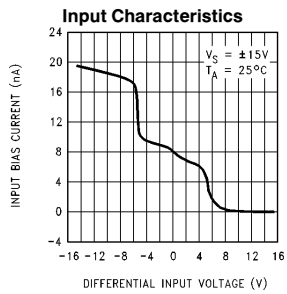

TL/H/5711-5

Typical Performance Characteristics (Continued)

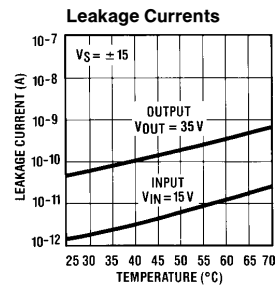
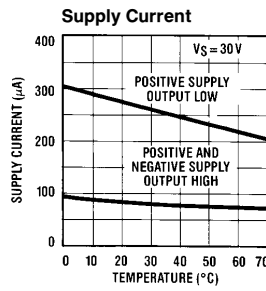
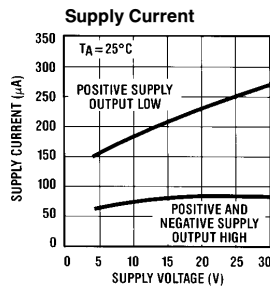

TL/H/5711-6

Applications Information

For applications information and typical applications, refer to the LM311 datasheet.

Auxiliary Circuits

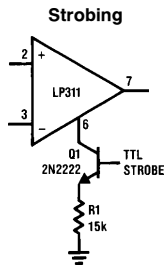

TL/H/5711-1

Note: Do not ground strobe pin.

Offset Balancing

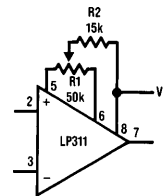

TL/H/5711-2

Test Circuits

Test Circuit 1 (Collector Output)

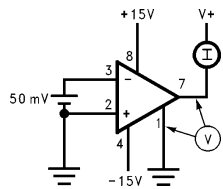

TL/H/5711-8

Test Circuit 2 (Emitter Output)

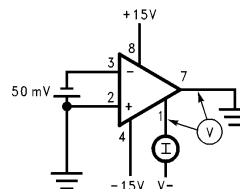

TL/H/5711-9

Test Circuit 3 (Collector Output)

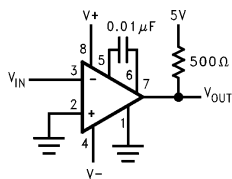

TL/H/5711-10

Test Circuit 4 (Emitter Output)

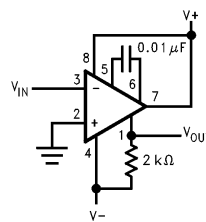

TL/H/5711-11

Physical Dimensions inches (millimeters)

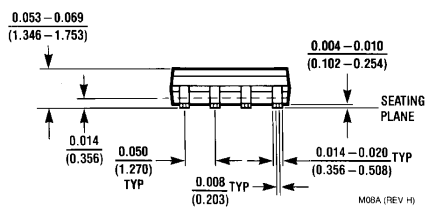
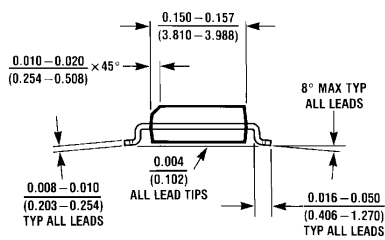
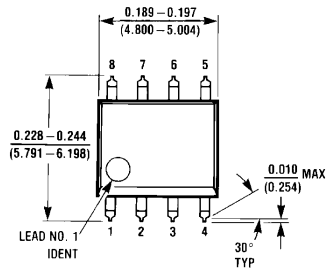

Order Number LP311M
NS Package Number M08A

M08A (REV H)

Physical Dimensions inches (millimeters) (Continued)

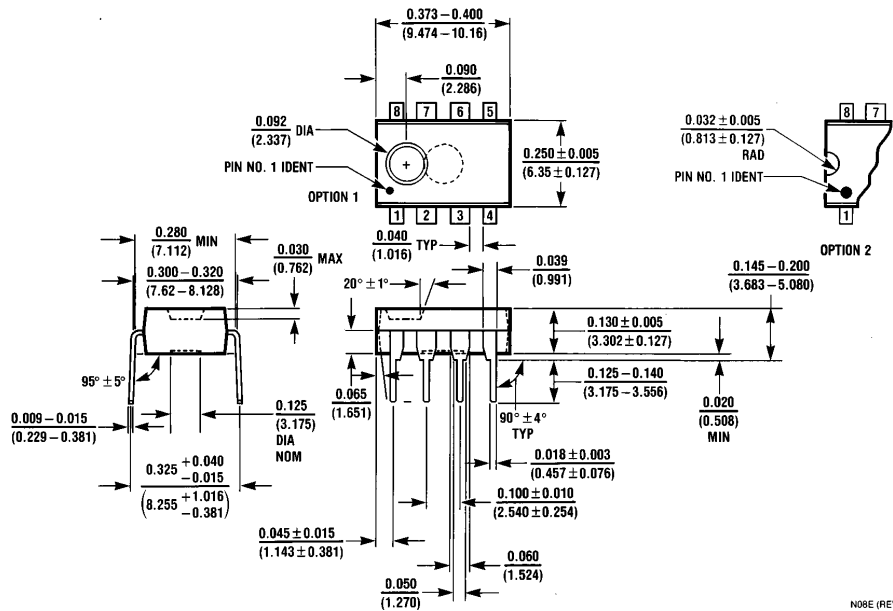

Molded Dual-In-Line Package (N)
Order Number LP311N
NS Package Number N08E

N08E (REV F)

LIFE SUPPORT POLICY

NATIONAL'S PRODUCTS ARE NOT AUTHORIZED FOR USE AS CRITICAL COMPONENTS IN LIFE SUPPORT DEVICES OR SYSTEMS WITHOUT THE EXPRESS WRITTEN APPROVAL OF THE PRESIDENT OF NATIONAL SEMICONDUCTOR CORPORATION. As used herein:

1. Life support devices or systems are devices or systems which, (a) are intended for surgical implant into the body, or (b) support or sustain life, and whose failure to perform, when properly used in accordance with instructions for use provided in the labeling, can be reasonably expected to result in a significant injury to the user.
2. A critical component is any component of a life support device or system whose failure to perform can be reasonably expected to cause the failure of the life support device or system, or to affect its safety or effectiveness.



National Semiconductor Corporation
 1111 West Bardin Road
 Arlington, TX 76017
 Tel: 1(800) 272-9959
 Fax: 1(800) 737-7018

National Semiconductor Europe
 Fax: (+49) 0-180-530 85 86
 Email: cnjwge@tevm2.nsc.com
 Deutsch Tel: (+49) 0-180-530 85 85
 English Tel: (+49) 0-180-532 78 32
 Français Tel: (+49) 0-180-532 93 58
 Italiano Tel: (+49) 0-180-534 16 80

National Semiconductor Hong Kong Ltd.
 13th Floor, Straight Block,
 Ocean Centre, 5 Canton Rd.
 Tsimshatsui, Kowloon
 Hong Kong
 Tel: (852) 2737-1600
 Fax: (852) 2736-9960

National Semiconductor Japan Ltd.
 Tel: 81-043-299-2309
 Fax: 81-043-299-2408

National does not assume any responsibility for use of any circuitry described, no circuit patent licenses are implied and National reserves the right at any time without notice to change said circuitry and specifications.