

LP3984

Micropower, 150mA Ultra Low-Dropout CMOS Voltage Regulator in Subminiature 4-I/O micro SMD Package

General Description

The LP3984 is designed for portable and wireless applications with demanding performance and space requirements.

The LP3984's performance is optimized for battery powered systems to deliver extremely low dropout voltage and low quiescent current. Regulator ground current increases only slightly in dropout, further prolonging the battery life.

Power supply rejection is better than 60 dB at low frequencies and starts to roll off at 10 kHz. High power supply rejection is maintained down to lower input voltage levels common to battery operated circuits.

The device is ideal for mobile phone and similar battery powered wireless applications. It provides up to 150 mA, from a 2.5V to 6V input, consuming less than 1.2 μ A in disable mode and has fast turn-on time less than 20 μ s.

The LP3984 is available in micro SMD and 5 pin SOT-23 package. Performance is specified for -40°C to $+125^{\circ}\text{C}$ temperature range and is available in 1.5V, 1.8V, 2.0V, and 3.1V output voltages. For other output voltage options from 1.5V to 3.5V, please contact National Semiconductor sales office.

Key Specifications

- 2.5 to 6.0V input range
- 150mA guaranteed output

- 60dB PSRR at 1kHz, 40dB at 10kHz @ 3.1V_{IN}
- $\leq 1.2\mu\text{A}$ quiescent current when shut down
- Fast Turn-On time: 20 μs (typ.)
- 75mV typ dropout with 150mA load
- -40 to $+125^{\circ}\text{C}$ junction temperature range for operation
- 1.5V, 1.8V, 2.0V, and 3.1V

Features

- Miniature 4-I/O micro SMD and SOT-23-5 package
- Logic controlled enable
- Stable with tantalum capacitors
- 1 μF Tantalum output capacitor
- Fast turn-on
- Thermal shutdown and short-circuit current limit

Applications

- CDMA cellular handsets
- Wideband CDMA cellular handsets
- GSM cellular handsets
- Portable information appliances

Typical Application Circuit

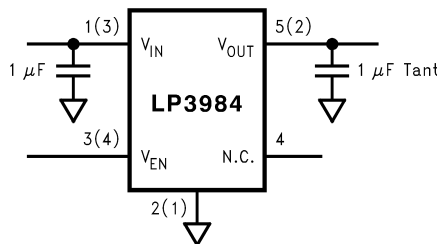

Note: Pin Numbers in parenthesis indicate micro SMD package.

20020402

Block Diagram

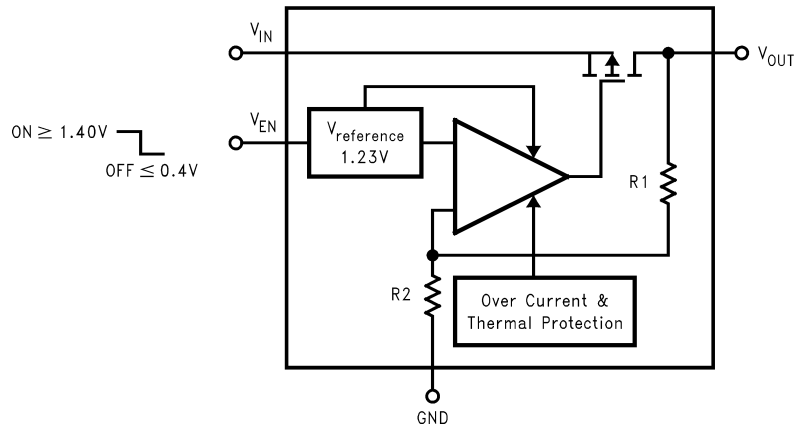

Pin Descriptions

Name	μSMD	SOT	Function
V _{EN}	4	3	Enable Input Logic, Enable High
GND	1	2	Common Ground
V _{OUT}	2	5	Output Voltage of the LDO
V _{IN}	3	1	Input Voltage of the LDO
N.C.		4	No Connection

Connection Diagrams

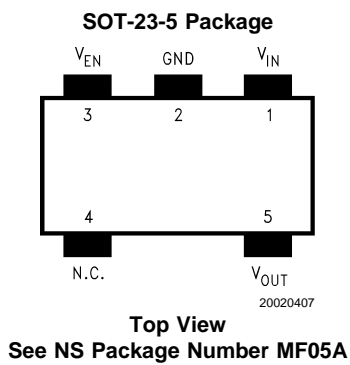

micro SMD, 4 Bump Package

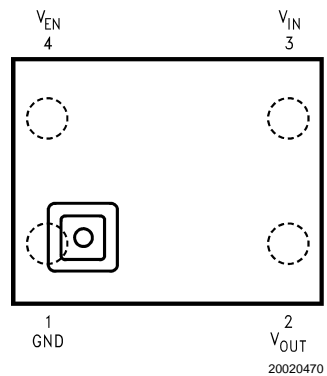

Note: The actual physical placement of the package marking will vary from part to part. The package marking will designate the date code. Package marking does not correlate to device type in any way.

Ordering Information

For micro SMD Package

Output Voltage (V)	Grade	LP3984 Supplied as 250 Units, Tape and Reel	LP3984 Supplied as 3000 Units, Tape and Reel
1.5	STD	LP3984IBP-1.5	LP3984IBPX-1.5
1.8	STD	LP3984IBP-1.8	LP3984IBPX-1.8
2.0	STD	LP3984IBP-2.0	LP3984IBPX-2.0
3.1	STD	LP3984IBP-3.1	LP3984IBPX-3.1

For SOT Package

Output Voltage (V)	Grade	LP3984 Supplied as 1000 Units, Tape and Reel	LP3984 Supplied as 3000 Units, Tape and Reel	Package Marking
1.5	STD	LP3984IMF-1.5	LP3984IMFX-1.5	LEAB
1.8	STD	LP3984IMF-1.8	LP3984IMFX-1.8	LEBB
2.0	STD	LP3984IMF-2.0	LP3984IMFX-2.0	LECB
3.1	STD	LP3984IMF-3.1	LP3984IMFX-3.1	LEDB

Absolute Maximum Ratings (Notes 1,

2)

If Military/Aerospace specified devices are required, please contact the National Semiconductor Sales Office/Distributors for availability and specifications.

V_{IN}, V_{OUT}, V_{EN}	-0.3 to 6.5V
Junction Temperature	150°C
Storage Temperature	-65°C to +150°C
Lead Temp. (Note 3)	235°C
Pad Temp. (Note 3)	235°C
Power Dissipation (Note 4)	
θ_{JA} (SOT23-5)	220°C/W
θ_{JA} (micro SMD)	340°C/W
Maximum Power Dissipation	
SOT23-5	364mW
Micro SMD	235mW

ESD Rating(Note 5)	
Human Body Model	2kV
Machine Model	200V

Operating Ratings (Notes 1, 2)

V_{IN}	2.5 to 6V
V_{EN}	0 to ($V_{IN} + 0.3V$)
Junction Temperature	-40°C to +125°C
Maximum Power Dissipation (Note 6)	
SOT23-5	250mW
micro SMD	160mW

Electrical Characteristics

Unless otherwise specified: $V_{IN} = 2.5V$ for 1.5, 1.8, & 2.0V options, $V_{IN} = V_{OUT} + 0.5$ for output options higher than 2.5V, $C_{IN} = 1 \mu F$, $I_{OUT} = 1mA$, $C_{OUT} = 1 \mu F$, tantalum. Typical values and limits appearing in standard typeface are for $T_J = 25^\circ C$. Limits appearing in **boldface type** apply over the entire junction temperature range for operation, -40°C to +125°C. (Note 7) (Note 8)

Symbol	Parameter	Conditions	Typ	Limit		Units
				Min	Max	
ΔV_{OUT}	Output Voltage Tolerance			-1.2	1.2	% of $V_{OUT(nom)}$
	Line Regulation Error	$V_{IN} = 2.5V$ to 4.5V for 1.5, 1.8, 2.0V options $V_{IN} = (V_{OUT} + 0.5V)$ to 4.5V for Voltage options higher than 2.5V	0.05	-0.15	0.15	%/V
	Load Regulation Error (Note 9)	$I_{OUT} = 1 mA$ to 150 mA LP3984IM5 (SOT23-5) LP3984IBP (micro SMD)	0.002 0.0009		0.005 0.002	%/mA
PSRR	Power Supply Rejection Ratio	$V_{IN} = V_{OUT(nom)} + 0.2V$, $f = 1 kHz$, $I_{OUT} = 50 mA$ (Figure 2)	60			dB
		$V_{IN} = V_{OUT(nom)} + 0.2V$, $f = 10 kHz$, $I_{OUT} = 50 mA$ (Figure 2)	40			
I_Q	Quiescent Current	$V_{EN} = 1.4V$, $I_{OUT} = 0 mA$	80		125	μA
		$V_{EN} = 1.4V$, $I_{OUT} = 0$ to 150 mA	110		150	
		$V_{EN} = 0.4V$	0.005		1.2	
	Dropout Voltage (Note 10)	$I_{OUT} = 1 mA$	0.6		2.5	mV
		$I_{OUT} = 50 mA$	25		40	
		$I_{OUT} = 100 mA$	50		80	
		$I_{OUT} = 150 mA$	75		120	
I_{SC}	Short Circuit Current Limit	Output Grounded (Steady State)	600			mA
$I_{OUT(PK)}$	Peak Output Current	$V_{OUT} \geq V_{OUT(nom)} - 5\%$	600	300		mA
T_{ON}	Turn-On Time (Note 11)		20			μs
e_n	Output Noise Voltage	BW = 10 Hz to 100 kHz, $C_{OUT} = 1\mu F$ tant.	90			μV_{rms}
I_{EN}	Maximum Input Current at EN	$V_{EN} = 0.4$ and $V_{IN} = 6.0$	± 1			nA

Electrical Characteristics (Continued)

Unless otherwise specified: $V_{IN} = 2.5V$ for 1.5, 1.8, & 2.0V options, $V_{IN} = V_{OUT} + 0.5$ for output options higher than 2.5V, $C_{IN} = 1 \mu F$, $I_{OUT} = 1mA$, $C_{OUT} = 1 \mu F$, tantalum. Typical values and limits appearing in standard typeface are for $T_J = 25^\circ C$. Limits appearing in **boldface type** apply over the entire junction temperature range for operation, $-40^\circ C$ to $+125^\circ C$. (Note 7) (Note 8)

Symbol	Parameter	Conditions	Typ	Limit		Units
				Min	Max	
V_{IL}	Maximum Low Level Input Voltage at EN	$V_{IN} = 2.5$ to $6.0V$			0.4	V
V_{IH}	Minimum High Level Input Voltage at EN	$V_{IN} = 2.5$ to $6.0V$		1.4		V
C_{OUT}	Output Capacitor	Capacitance		1	22	μF
		ESR		2	10	Ω
TSD	Thermal Shutdown Temperature		160			$^\circ C$
	Thermal Shutdown Hysteresis		20			$^\circ C$

Note 1: Absolute Maximum Ratings are limits beyond which damage to the device may occur. Operating Ratings are conditions under which operation of the device is guaranteed. Operating Ratings do not imply guaranteed performance limits. For guaranteed performance limits and associated test conditions, see the Electrical Characteristics tables.

Note 2: All voltages are with respect to the potential at the GND pin.

Note 3: Additional information on lead temperature and pad temperature can be found in National Semiconductor Application Note (AN-1112).

Note 4: The Absolute Maximum power dissipation depends on the ambient temperature and can be calculated using the formula:

$$P_D = (T_J - T_A) / \theta_{JA}$$

where T_J is the junction temperature, T_A is the ambient temperature, and θ_{JA} is the junction-to-ambient thermal resistance. The 364mW rating for SOT23-5 appearing under Absolute Maximum Ratings results from substituting the Absolute Maximum junction temperature, $150^\circ C$, for T_J , $70^\circ C$ for T_A , and $220^\circ C/W$ for θ_{JA} . More power can be dissipated safely at ambient temperatures below $70^\circ C$. Less power can be dissipated safely at ambient temperatures above $70^\circ C$. The Absolute Maximum power dissipation for SOT23-5 can be increased by 4.5mW for each degree below $70^\circ C$, and it must be derated by 4.5mW for each degree above $70^\circ C$.

Note 5: The human body model is 100pF discharged through 1.5k Ω resistor into each pin. The machine model is a 200 pF capacitor discharged directly into each pin.

Note 6: Like the Absolute Maximum power dissipation, the maximum power dissipation for operation depends on the ambient temperature. The 250mW rating for SOT23-5 appearing under Operating Ratings results from substituting the maximum junction temperature for operation, $125^\circ C$, for T_J , $70^\circ C$ for T_A , and $220^\circ C/W$ for θ_{JA} into (Note 4) above. More power can be dissipated at ambient temperatures below $70^\circ C$. Less power can be dissipated at ambient temperatures above $70^\circ C$. The maximum power dissipation for operation can be increased by 4.5mW for each degree below $70^\circ C$, and it must be derated by 4.5mW for each degree above $70^\circ C$.

Note 7: All limits are guaranteed. All electrical characteristics having room-temperature limits are tested during production with $T_J = 25^\circ C$ or correlated using Statistical Quality Control (SQC) methods. All hot and cold limits are guaranteed by correlating the electrical characteristics to process and temperature variations and applying statistical process control.

Note 8: The target output voltage, which is labeled $V_{OUT(nom)}$, is the desired voltage option.

Note 9: An increase in the load current results in a slight decrease in the output voltage and vice versa.

Note 10: Dropout voltage is the input-to-output voltage difference at which the output voltage is 100mV below its nominal value. This specification does not apply for input voltages below 2.5V.

Note 11: Turn-on time is time measured between the enable input just exceeding V_{IH} and the output voltage just reaching 95% of its nominal value.

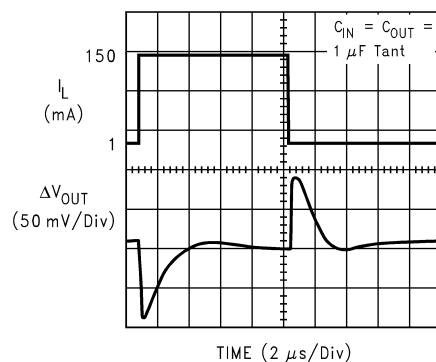

20020408

FIGURE 1. Output AC Line Regulation Input Perturbation

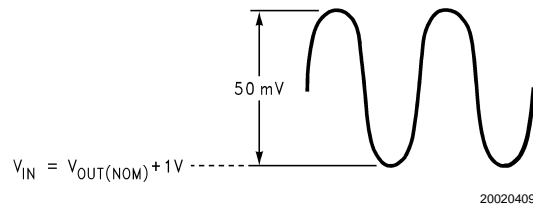
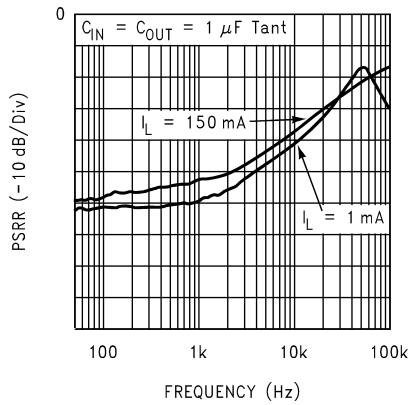

FIGURE 2. PSRR Input Perturbation

Typical Performance Characteristics Unless otherwise specified, $C_{IN} = C_{OUT} = 1 \mu F$ Tantalum, $V_{IN} = 2.5$ for 1.5, 1.8, and 2.0V options, $V_{IN} = V_{OUT} + 0.2V$ for output options higher than 2.5V, $T_A = 25^\circ C$, Enable pin is tied to V_{IN} .

Power Supply Rejection Ratio ($V_{IN} = 3.5V$)



Power Supply Rejection Ratio ($V_{IN} = 3.5V$)

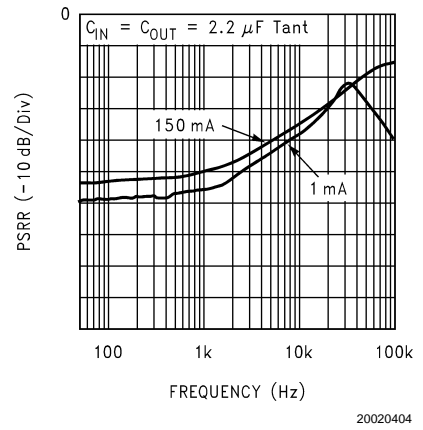

Power Supply Rejection Ratio ($V_{IN} = 3.5V$)

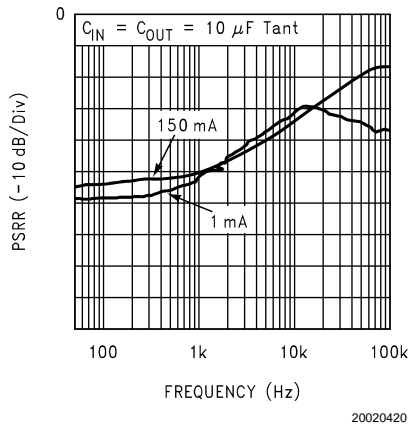

Power Supply Rejection Ratio (LP3984-1.5, $V_{IN} = 2.5V$)

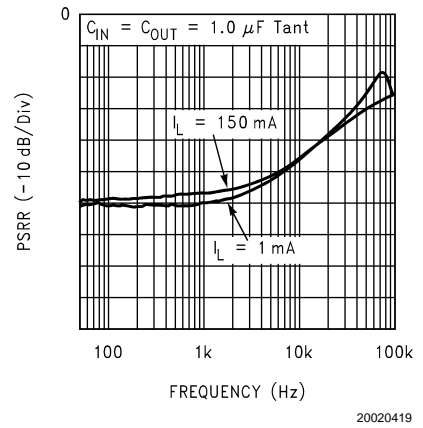

Typical Performance Characteristics Unless otherwise specified, $C_{IN} = C_{OUT} = 1 \mu\text{F}$ Tantalum, $V_{IN} = 2.5$ for 1.5, 1.8, and 2.0V options, $V_{IN} = V_{OUT} + 0.2\text{V}$ for output options higher than 2.5V, $T_A = 25^\circ\text{C}$, Enable pin is tied to V_{IN} . (Continued)

Line Transient Response (LP3984-3.1)

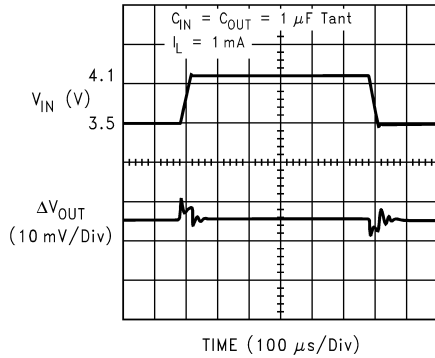

Line Transient Response (LP3984-3.1)

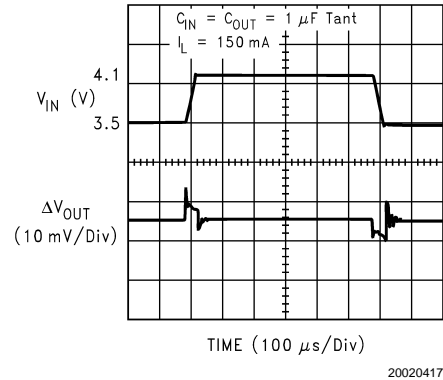

Line Transient Response (LP3984-3.1)

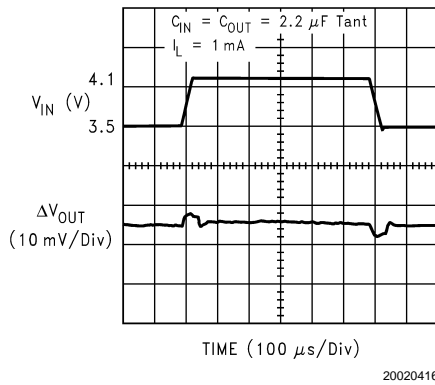

Line Transient Response (LP3984-3.1)

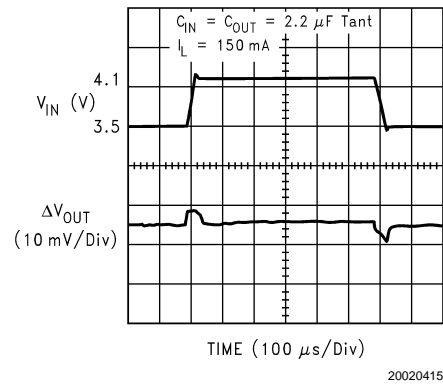

Line Transient Response (LP3984-3.1)

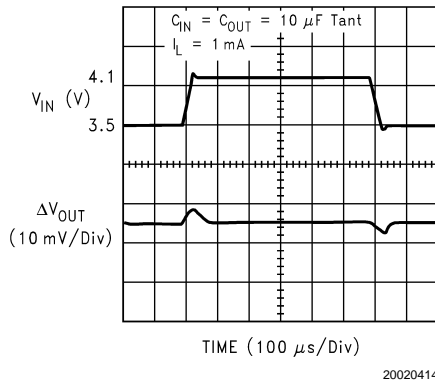

Line Transient Response (LP3984-3.1)

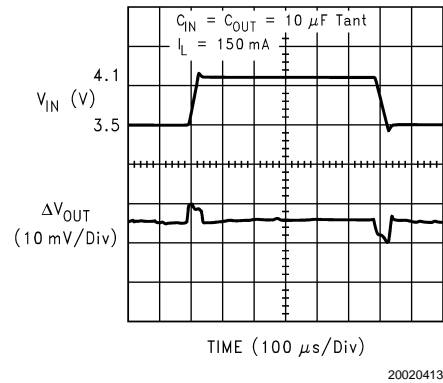

Typical Performance Characteristics Unless otherwise specified, $C_{IN} = C_{OUT} = 1 \mu\text{F}$ Tantalum, $V_{IN} = 2.5$ for 1.5, 1.8, and 2.0V options, $V_{IN} = V_{OUT} + 0.2\text{V}$ for output options higher than 2.5V, $T_A = 25^\circ\text{C}$, Enable pin is tied to V_{IN} . (Continued)

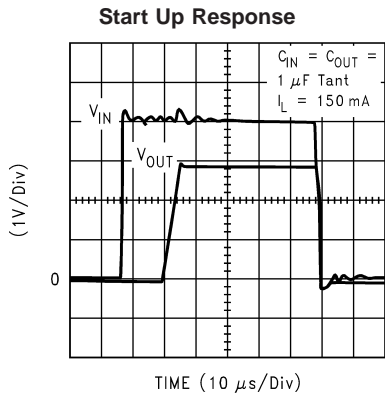

20020412

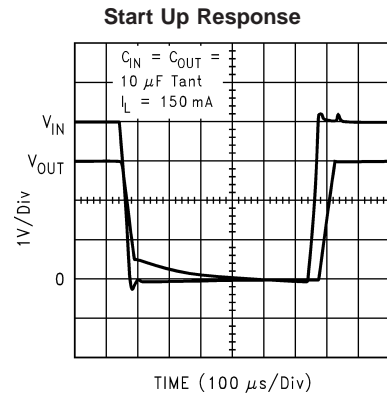

20020411

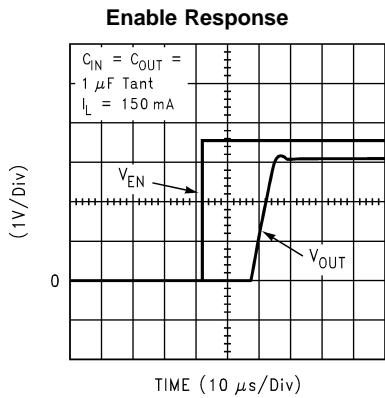

20020410

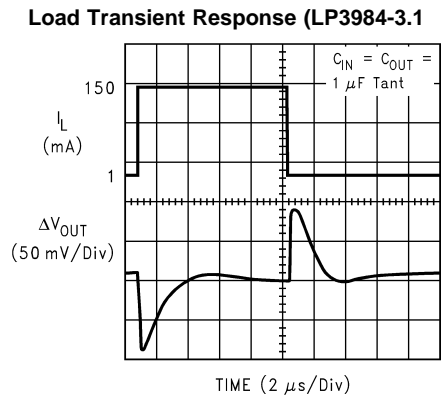

20020408

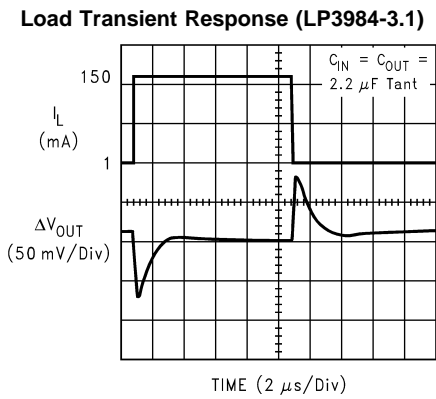

20020406

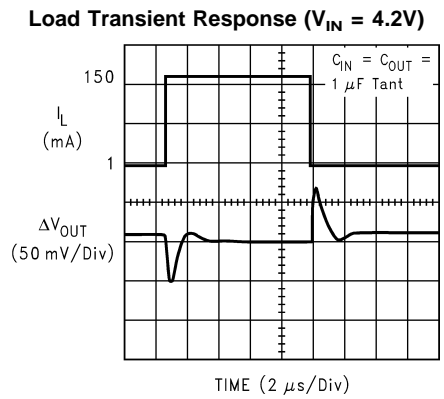

20020405

Application Hints

External Capacitors

Like any low-dropout regulator, the LP3984 requires external capacitors for regulator stability. The LP3984 is specifically designed for portable applications requiring minimum board space and smallest components. These capacitors must be correctly selected for good performance.

Input Capacitor

An input capacitance of $\approx 1\mu\text{F}$ is required between the LP3984 input pin and ground (the amount of the capacitance may be increased without limit).

This capacitor must be located a distance of not more than 1cm from the input pin and returned to a clean analog ground. Any good quality ceramic, tantalum, or film capacitor may be used at the input.

Important: Tantalum capacitors can suffer catastrophic failures due to surge current when connected to a low-impedance source of power (like a battery or a very large capacitor). If a tantalum capacitor is used at the input, it must be guaranteed by the manufacturer to have a surge current rating sufficient for the application.

There are no requirements for the ESR on the input capacitor, but tolerance and temperature coefficient must be considered when selecting the capacitor to ensure the capacitance will be $\approx 1\mu\text{F}$ over the entire operating temperature range.

Output Capacitor

The LP3984 is designed specifically to work with tantalum output capacitors. A tantalum capacitor in 1 to 22 μF range with 2Ω to 10Ω ESR range is suitable in the LP3984 application circuit.

It may also be possible to use film capacitors at the output, but these are not as attractive for reasons of size and cost.

The output capacitor must meet the requirement for minimum amount of capacitance and also have an ESR (Equivalent Series Resistance) value which is within a stable range (2Ω to 10Ω).

No-Load Stability

The LP3984 will remain stable and in regulation with no external load. This is specially important in CMOS RAM keep-alive applications.

On/Off Input Operation

The LP3984 is turned off by pulling the V_{EN} pin low, and turned on by pulling it high. If this feature is not used, the V_{EN} pin should be tied to V_{IN} to keep the regulator output on at all time. To assure proper operation, the signal source used to drive the V_{EN} input must be able to swing above and below the specified turn-on/off voltage thresholds listed in the Electrical Characteristics section under V_{IL} and V_{IH} .

Fast On-Time

The LP3984 utilizes a speed up circuitry to ramp up the internal V_{REF} voltage to its final value to achieve a fast output turn on time.

Micro SMD Mounting

The micro SMD package requires specific mounting techniques which are detailed in National Semiconductor Application Note (AN-1112). Referring to the section *Surface Mount Technology (SMT) Assembly Considerations*, it should be noted that the pad style which must be used with the 5 pin package is NSMD (non-solder mask defined) type.

For best results during assembly, alignment ordinals on the PC board may be used to facilitate placement of the micro SMD device.

Micro SMD Light Sensitivity

Exposing the micro SMD device to direct sunlight will cause misoperation of the device. Light sources such as Halogen lamps can effect electrical performance if brought near to the device.

The wavelengths which have most detrimental effect are reds and infra-reds, which means that the fluorescent lighting used inside most buildings has very little effect on performance. A micro SMD test board was brought to within 1cm of a fluorescent desk lamp and the effect on the regulated output voltage was negligible, showing a deviation of less than 0.1% from nominal.

Physical Dimensions inches (millimeters)
unless otherwise noted

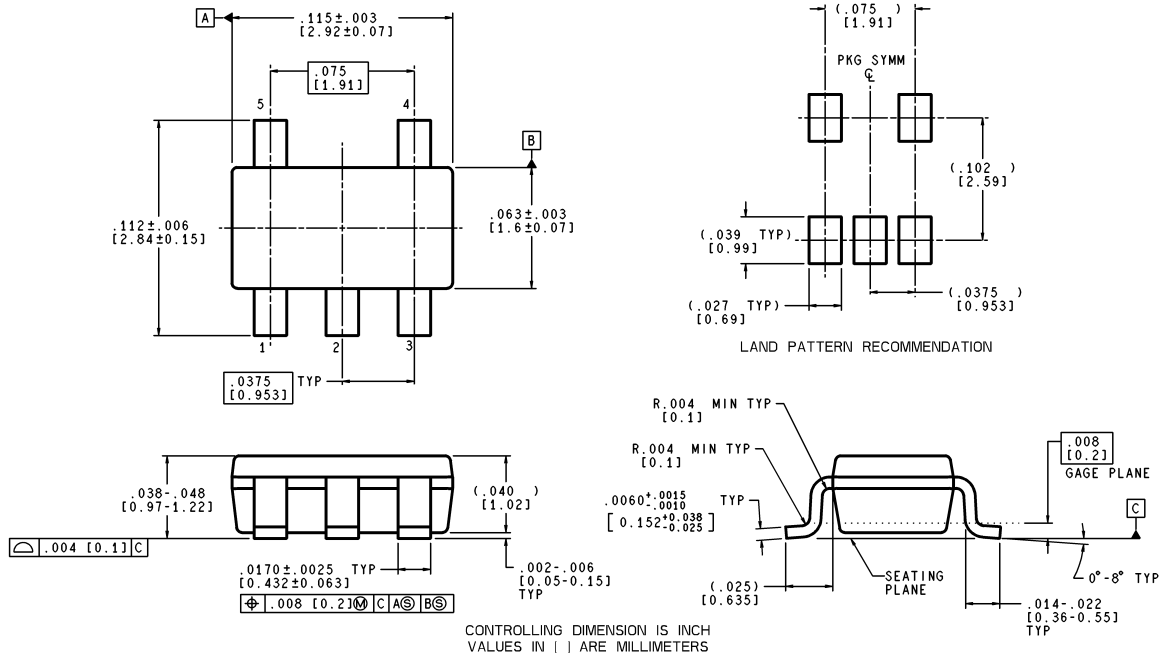

MF05A (Rev A)

**5-Lead Small Outline Package (MF)
NS Package Number MF05A**

Physical Dimensions inches (millimeters) unless otherwise noted (Continued)

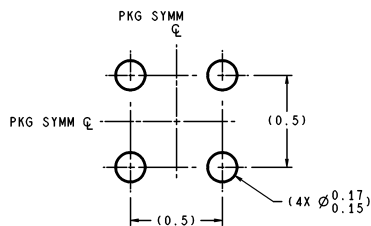

LAND PATTERN RECOMMENDATION

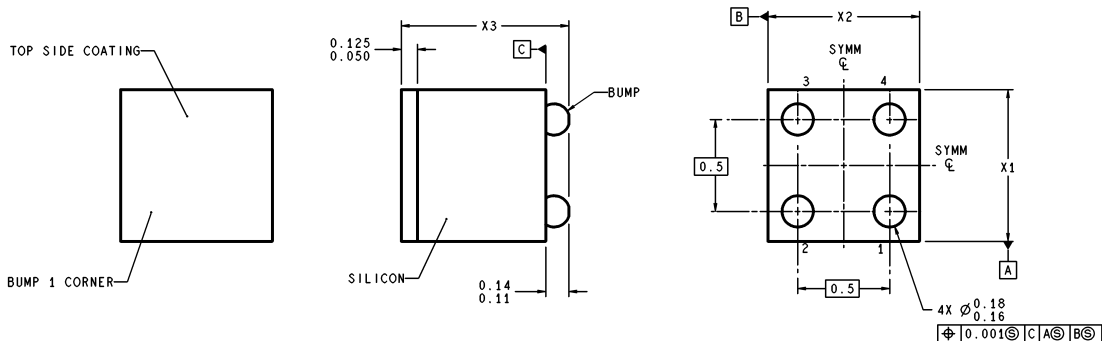

DIMENSIONS ARE IN MILLIMETERS

BPA04XXX (Rev C)

Micro SMD, 4 Bump Package (BPA04)
NS Package Number bpa04DHC
X1 = 0.853 ± 0.03mm
X2 = 0.955 ± 0.03mm
X3 = 0.900 ± 0.1mm

LIFE SUPPORT POLICY

NATIONAL'S PRODUCTS ARE NOT AUTHORIZED FOR USE AS CRITICAL COMPONENTS IN LIFE SUPPORT DEVICES OR SYSTEMS WITHOUT THE EXPRESS WRITTEN APPROVAL OF THE PRESIDENT AND GENERAL COUNSEL OF NATIONAL SEMICONDUCTOR CORPORATION. As used herein:

1. Life support devices or systems are devices or systems which, (a) are intended for surgical implant into the body, or (b) support or sustain life, and whose failure to perform when properly used in accordance with instructions for use provided in the labeling, can be reasonably expected to result in a significant injury to the user.
2. A critical component is any component of a life support device or system whose failure to perform can be reasonably expected to cause the failure of the life support device or system, or to affect its safety or effectiveness.

National Semiconductor Corporation
 Americas
 Email: support@nsc.com

National Semiconductor Europe
 Fax: +49 (0) 180-530 85 86
 Email: europe.support@nsc.com
 Deutsch Tel: +49 (0) 69 9508 6208
 English Tel: +44 (0) 870 24 0 2171
 Français Tel: +33 (0) 1 41 91 8790

National Semiconductor Asia Pacific Customer Response Group
 Tel: 65-2544466
 Fax: 65-2504466
 Email: ap.support@nsc.com

National Semiconductor Japan Ltd.
 Tel: 81-3-5639-7560
 Fax: 81-3-5639-7507

www.national.com