

CD4066BM/CD4066BC Quad Bilateral Switch

General Description

The CD4066BM/CD4066BC is a quad bilateral switch intended for the transmission or multiplexing of analog or digital signals. It is pin-for-pin compatible with CD4016BM/CD4016BC, but has a much lower "ON" resistance, and "ON" resistance is relatively constant over the input-signal range.

Features

- Wide supply voltage range 3V to 15V
- High noise immunity 0.45 V_{DD} (typ.)
- Wide range of digital and analog switching $\pm 7.5 V_{PEAK}$
- "ON" resistance for 15V operation 80 Ω
- Matched "ON" resistance over 15V signal input $\Delta R_{ON} = 5 \Omega$ (typ.)
- "ON" resistance flat over peak-to-peak signal range
- High "ON"/"OFF" output voltage ratio @ $f_{is} = 10$ kHz, $R_L = 10$ k Ω 65 dB (typ.)
- High degree linearity 0.1% distortion (typ.)
- High degree linearity @ $f_{is} = 1$ kHz, $V_{is} = 5V_{p-p}$
- High degree linearity $V_{DD} - V_{SS} = 10V$, $R_L = 10$ k Ω

- Extremely low "OFF" switch leakage 0.1 nA (typ.) @ $V_{DD} - V_{SS} = 10V$, $T_A = 25^\circ C$
- Extremely high control input impedance 10¹² Ω (typ.)
- Low crosstalk -50 dB (typ.) between switches @ $f_{is} = 0.9$ MHz, $R_L = 1$ k Ω
- Frequency response, switch "ON" 40 MHz (typ.)

Applications

- Analog signal switching/multiplexing
 - Signal gating
 - Squelch control
 - Chopper
 - Modulator/Demodulator
 - Commutating switch
- Digital signal switching/multiplexing
- CMOS logic implementation
- Analog-to-digital/digital-to-analog conversion
- Digital control of frequency, impedance, phase, and analog-signal-gain

Schematic and Connection Diagrams

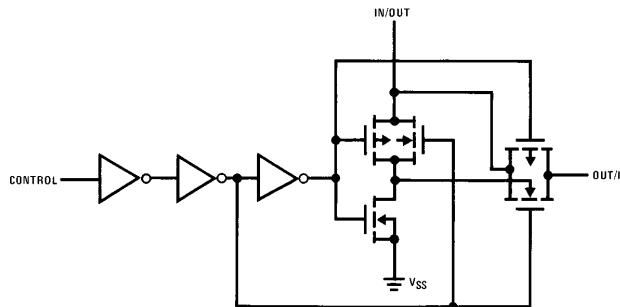

Order Number CD4066B

Dual-In-Line Package

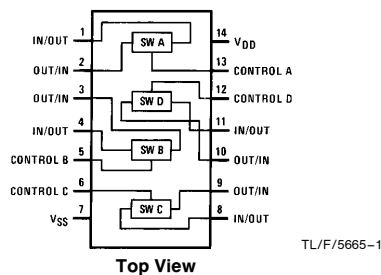

Absolute Maximum Ratings (Notes 1 & 2)

If Military/Aerospace specified devices are required, please contact the National Semiconductor Sales Office/Distributors for availability and specifications.

Supply Voltage (V_{DD})	-0.5V to +18V
Input Voltage (V_{IN})	-0.5V to $V_{DD} + 0.5V$
Storage Temperature Range (T_S)	-65°C to +150°C
Power Dissipation (P_D)	
Dual-In-Line	700 mW
Small Outline	500 mW
Lead Temperature (T_L)	
(Soldering, 10 seconds)	300°C

Recommended Operating Conditions (Note 2)

Supply Voltage (V_{DD})	3V to 15V
Input Voltage (V_{IN})	0V to V_{DD}
Operating Temperature Range (T_A)	
CD4066BM	-55°C to +125°C
CD4066BC	-40°C to +85°C

DC Electrical Characteristics CD4066BM (Note 2)

Symbol	Parameter	Conditions	-55°C		+25°C			+125°C		Units
			Min	Max	Min	Typ	Max	Min	Max	
I_{DD}	Quiescent Device Current	$V_{DD} = 5V$		0.25		0.01	0.25		7.5	μA
		$V_{DD} = 10V$		0.5		0.01	0.5		15	μA
		$V_{DD} = 15V$		1.0		0.01	1.0		30	μA

SIGNAL INPUTS AND OUTPUTS

R_{ON}	"ON" Resistance	$R_L = 10\text{ k}\Omega$ to $\frac{V_{DD}-V_{SS}}{2}$ $V_C = V_{DD}$, $V_{IS} = V_{SS}$ to V_{DD} $V_{DD} = 5V$ $V_{DD} = 10V$ $V_{DD} = 15V$		800 310 200		270 120 80	1050 400 240		1300 550 320	Ω Ω Ω
ΔR_{ON}	Δ "ON" Resistance Between any 2 of 4 Switches	$R_L = 10\text{ k}\Omega$ to $\frac{V_{DD}-V_{SS}}{2}$ $V_C = V_{DD}$, $V_{IS} = V_{SS}$ to V_{DD} $V_{DD} = 10V$ $V_{DD} = 15V$				10 5				Ω Ω
I_{IS}	Input or Output Leakage Switch "OFF"	$V_C = 0$ $V_{IS} = 15V$ and 0V, $V_{OS} = 0V$ and 15V		± 50		± 0.1	± 50		± 500	nA

CONTROL INPUTS

V_{ILC}	Low Level Input Voltage	$V_{IS} = V_{SS}$ and V_{DD} $V_{OS} = V_{DD}$ and V_{SS} $I_{IS} = \pm 10\ \mu A$ $V_{DD} = 5V$ $V_{DD} = 10V$ $V_{DD} = 15V$		1.5 3.0 4.0		2.25 4.5 6.75	1.5 3.0 4.0		1.5 3.0 4.0	V V V
V_{IHC}	High Level Input Voltage	$V_{DD} = 5V$ $V_{DD} = 10V$ (see note 6) $V_{DD} = 15V$	3.5 7.0 11.0		3.5 7.0 11.0	2.75 5.5 8.25		3.5 7.0 11.0		V V V
I_{IN}	Input Current	$V_{DD} - V_{SS} = 15V$ $V_{DD} \geq V_{IS} \geq V_{SS}$ $V_{DD} \geq V_C \geq V_{SS}$		± 0.1		$\pm 10^{-5}$	± 0.1		± 1.0	μA

DC Electrical Characteristics CD4066BC (Note 2)

Symbol	Parameter	Conditions	-40°C		+25°C			+85°C		Units
			Min	Max	Min	Typ	Max	Min	Max	
I_{DD}	Quiescent Device Current	$V_{DD} = 5V$		1.0		0.01	1.0		7.5	μA
		$V_{DD} = 10V$		2.0		0.01	2.0		15	μA
		$V_{DD} = 15V$		4.0		0.01	4.0		30	μA

DC Electrical Characteristics (Continued) CD4066BC (Note 2)

Symbol	Parameter	Conditions	-40°C		+25°C			+85°C		Units
			Min	Max	Min	Typ	Max	Min	Max	
SIGNAL INPUTS AND OUTPUTS										
R _{ON}	"ON" Resistance	$R_L = 10\text{ k}\Omega$ to $\frac{V_{DD}-V_{SS}}{2}$ $V_C = V_{DD}$, V_{SS} to V_{DD} $V_{DD} = 5\text{V}$ $V_{DD} = 10\text{V}$ $V_{DD} = 15\text{V}$		850 330 210		270 120 80	1050 400 240		1200 520 300	Ω Ω Ω
ΔR_{ON}	Δ "ON" Resistance Between Any 2 of 4 Switches	$R_L = 10\text{ k}\Omega$ to $\frac{V_{DD}-V_{SS}}{2}$ $V_{CC} = V_{DD}$, $V_{IS} = V_{SS}$ to V_{DD} $V_{DD} = 10\text{V}$ $V_{DD} = 15\text{V}$				10 5				Ω Ω
I _{IS}	Input or Output Leakage Switch "OFF"	$V_C = 0$		± 50		± 0.1	± 50		± 200	nA
CONTROL INPUTS										
V _{ILC}	Low Level Input Voltage	$V_{IS} = V_{SS}$ and V_{DD} $V_{OS} = V_{DD}$ and V_{SS} $I_{IS} = \pm 10\mu\text{A}$ $V_{DD} = 5\text{V}$ $V_{DD} = 10\text{V}$ $V_{DD} = 15\text{V}$		1.5 3.0 4.0		2.25 4.5 6.75	1.5 3.0 4.0		1.5 3.0 4.0	V V V
V _{IHC}	High Level Input Voltage	$V_{DD} = 5\text{V}$ $V_{DD} = 10\text{V}$ (See note 6) $V_{DD} = 15\text{V}$	3.5 7.0 11.0		3.5 7.0 11.0	2.75 5.5 8.25		3.5 7.0 11.0		V V V
I _{IN}	Input Current	$V_{DD} - V_{SS} = 15\text{V}$ $V_{DD} \geq V_{IS} \geq V_{SS}$ $V_{DD} \geq V_C \geq V_{SS}$		± 0.3		$\pm 10^{-5}$	± 0.3		± 1.0	μA

AC Electrical Characteristics* $T_A = 25^\circ\text{C}$, $t_r = t_f = 20\text{ ns}$ and $V_{SS} = 0\text{V}$ unless otherwise noted

Symbol	Parameter	Conditions	Min	Typ	Max	Units
t _{PHL} , t _{PLH}	Propagation Delay Time Signal Input to Signal Output	$V_C = V_{DD}$, $C_L = 50\text{ pF}$, (Figure 1) $R_L = 200\text{k}$ $V_{DD} = 5\text{V}$ $V_{DD} = 10\text{V}$ $V_{DD} = 15\text{V}$		25 15 10	55 35 25	ns ns ns
t _{PZH} , t _{PZL}	Propagation Delay Time Control Input to Signal Output High Impedance to Logical Level	$R_L = 1.0\text{ k}\Omega$, $C_L = 50\text{ pF}$, (Figures 2 and 3) $V_{DD} = 5\text{V}$ $V_{DD} = 10\text{V}$ $V_{DD} = 15\text{V}$			125 60 50	ns ns ns
t _{PHZ} , t _{PLZ}	Propagation Delay Time Control Input to Signal Output Logical Level to High Impedance Sine Wave Distortion Frequency Response-Switch "ON" (Frequency at -3 dB)	$R_L = 1.0\text{ k}\Omega$, $C_L = 50\text{ pF}$, (Figures 2 and 3) $V_{DD} = 5\text{V}$ $V_{DD} = 10\text{V}$ $V_{DD} = 15\text{V}$ $V_C = V_{DD} = 5\text{V}$, $V_{SS} = -5\text{V}$ $R_L = 10\text{ k}\Omega$, $V_{IS} = 5V_{p-p}$, $f = 1\text{ kHz}$, (Figure 4) $V_C = V_{DD} = 5\text{V}$, $V_{SS} = -5\text{V}$, $R_L = 1\text{ k}\Omega$, $V_{IS} = 5V_{p-p}$, $20\text{ Log}_{10} V_{OS}/V_{OS}$ (1 kHz) - dB, (Figure 4)		0.1 40	125 60 50	ns ns ns % MHz

AC Electrical Characteristics* (Continued) $T_A = 25^\circ\text{C}$, $t_r = t_f = 20\text{ ns}$ and $V_{SS} = 0\text{V}$ unless otherwise noted

Symbol	Parameter	Conditions	Min	Typ	Max	Units
	Feedthrough — Switch "OFF" (Frequency at -50 dB)	$V_{DD} = 5.0\text{V}$, $V_{CC} = V_{SS} = -5.0\text{V}$, $R_L = 1\text{ k}\Omega$, $V_{IS} = 5.0\text{V}_{p-p}$, 20 Log_{10} , $V_{OS}/V_{IS} = -50\text{ dB}$, (Figure 4)		1.25		
	Crosstalk Between Any Two Switches (Frequency at -50 dB)	$V_{DD} = V_{C(A)} = 5.0\text{V}$; $V_{SS} = V_{C(B)} = 5.0\text{V}$, $R_L = 1\text{ k}\Omega$, $V_{IS(A)} = 5.0\text{V}_{p-p}$, 20 Log_{10} , $V_{OS(B)}/V_{IS(A)} = -50\text{ dB}$ (Figure 5)		0.9		MHz
	Crosstalk; Control Input to Signal Output	$V_{DD} = 10\text{V}$, $R_L = 10\text{ k}\Omega$, $R_{IN} = 1.0\text{ k}\Omega$, $V_{CC} = 10\text{V}$ Square Wave, $C_L = 50\text{ pF}$ (Figure 6)		150		mV_{p-p}
	Maximum Control Input	$R_L = 1.0\text{ k}\Omega$, $C_L = 50\text{ pF}$, (Figure 7) $V_{OS(f)} = 1/2 V_{OS}(1.0\text{ kHz})$ $V_{DD} = 5.0\text{V}$ $V_{DD} = 10\text{V}$ $V_{DD} = 15\text{V}$		6.0 8.0 8.5		MHz MHz MHz
C_{IS}	Signal Input Capacitance			8.0		pF
C_{OS}	Signal Output Capacitance	$V_{DD} = 10\text{V}$		8.0		pF
C_{IOS}	Feedthrough Capacitance	$V_C = 0\text{V}$		0.5		pF
C_{IN}	Control Input Capacitance			5.0	7.5	pF

*AC Parameters are guaranteed by DC correlated testing.

Note 1: "Absolute Maximum Ratings" are those values beyond which the safety of the device cannot be guaranteed. They are not meant to imply that the devices should be operated at these limits. The tables of "Recommended Operating Conditions" and "Electrical Characteristics" provide conditions for actual device operation.

Note 2: $V_{SS} = 0\text{V}$ unless otherwise specified.

Note 3: These devices should not be connected to circuits with the power "ON".

Note 4: In all cases, there is approximately 5 pF of probe and jig capacitance in the output; however, this capacitance is included in C_L wherever it is specified.

Note 5: V_{IS} is the voltage at the in/out pin and V_{OS} is the voltage at the out/in pin. V_C is the voltage at the control input.

Note 6: Conditions for V_{IH} : a) $V_{IS} = V_{DD}$, $I_{OS} = \text{standard B series } I_{OH}$ b) $V_{IS} = 0\text{V}$, $I_{OL} = \text{standard B series } I_{OL}$.

AC Test Circuits and Switching Time Waveforms

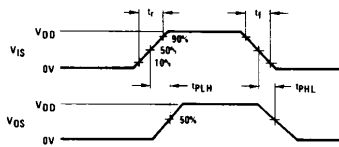
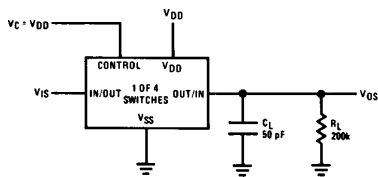

FIGURE 1. t_{PLH} , t_{PLL} Propagation Delay Time Signal Input to Signal Output

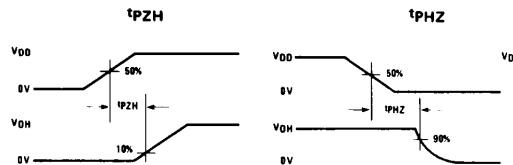
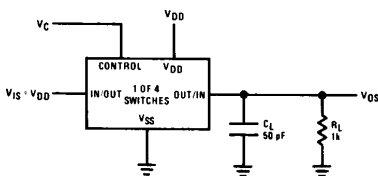

FIGURE 2. t_{PZH} , t_{PHZ} Propagation Delay Time Control to Signal Output

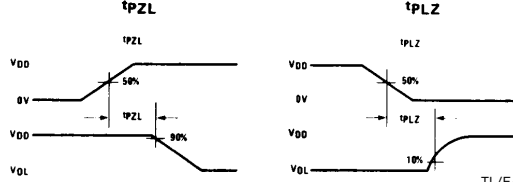
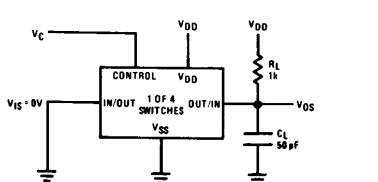

FIGURE 3. t_{PZL} , t_{PLZ} Propagation Delay Time Control to Signal Output

TL/F/5685-2

AC Test Circuits and Switching Time Waveforms (Continued)

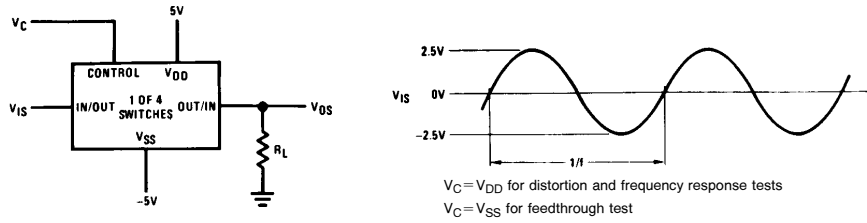

FIGURE 4. Sine Wave Distortion, Frequency Response and Feedthrough

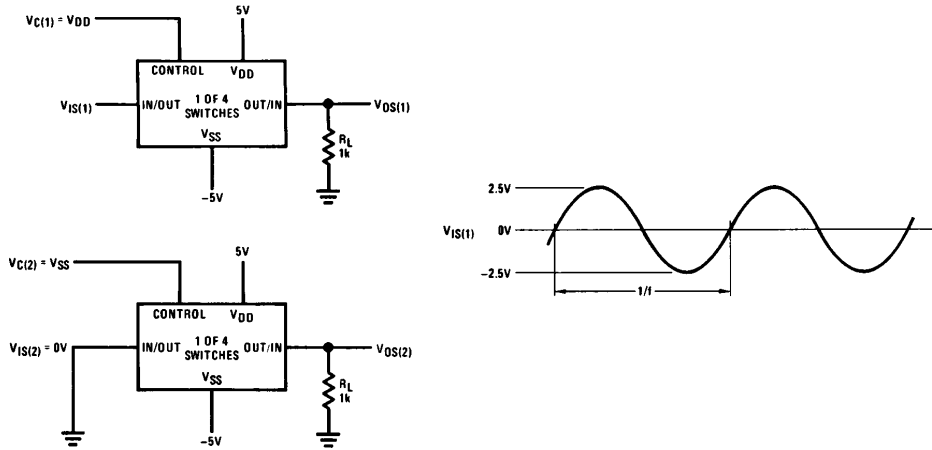

FIGURE 5. Crosstalk Between Any Two Switches

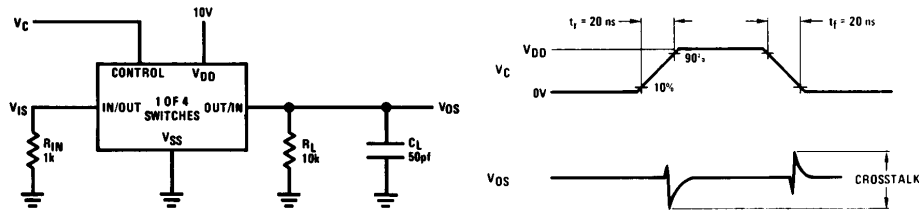

FIGURE 6. Crosstalk: Control Input to Signal Output

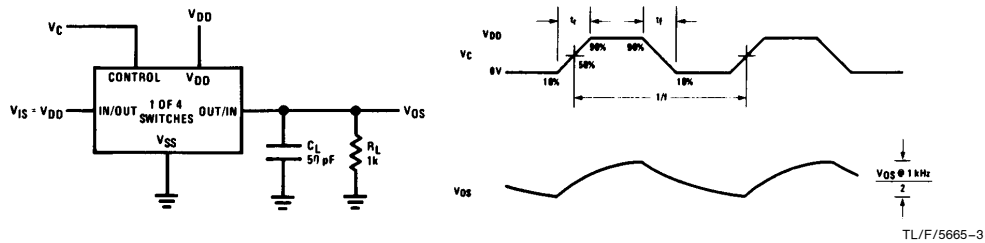
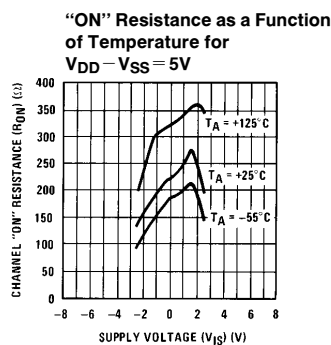
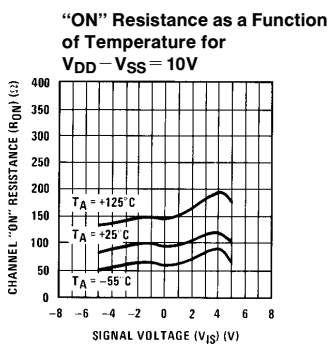
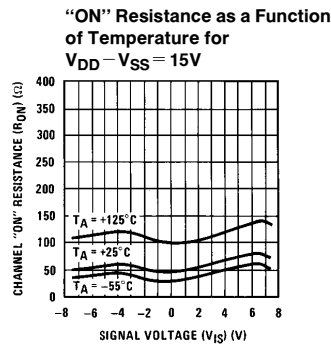
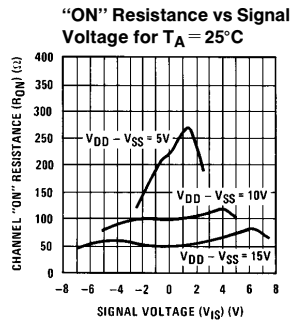

FIGURE 7. Maximum Control Input Frequency

TL/F/5665-3

Typical Performance Characteristics



TL/F/5665-4

Special Considerations

In applications where separate power sources are used to drive V_{DD} and the signal input, the V_{DD} current capability should exceed V_{DD}/R_L (R_L = effective external load of the 4 CD4066BM/CD4066BC bilateral switches). This provision avoids any permanent current flow or clamp action of the V_{DD} supply when power is applied or removed from CD4066BM/CD4066BC.

In certain applications, the external load-resistor current may include both V_{DD} and signal-line components. To avoid

drawing V_{DD} current when switch current flows into terminals 1, 4, 8 or 11, the voltage drop across the bidirectional switch must not exceed 0.6V at $T_A \leq 25^\circ\text{C}$, or 0.4V at $T_A > 25^\circ\text{C}$ (calculated from R_{ON} values shown).

No V_{DD} current will flow through R_L if the switch current flows into terminals 2, 3, 9 or 10.

Physical Dimensions inches (millimeters)

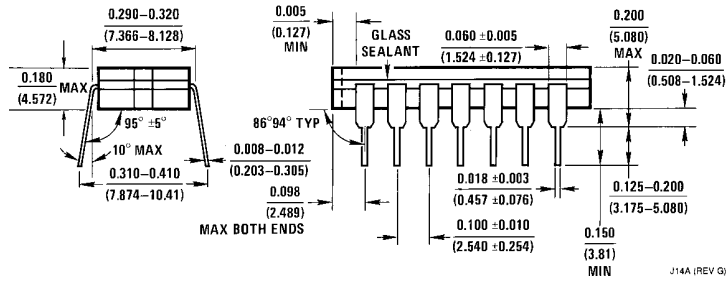
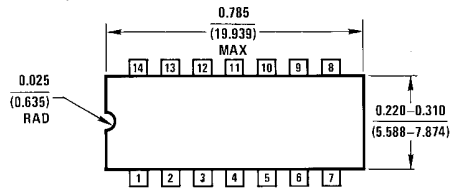

CerDip (J)
Order Number CD4066BMJ or CD4066BCJ
NS Package Number J14A

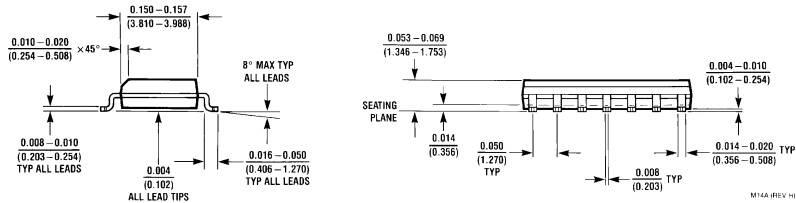
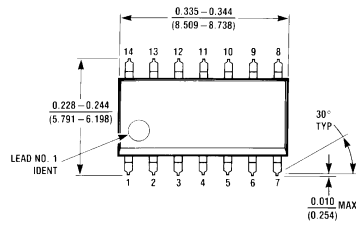

S.O. Package (M)
Order Number CD4066BCM
NS Package Number M14A

Physical Dimensions inches (millimeters) (Continued)

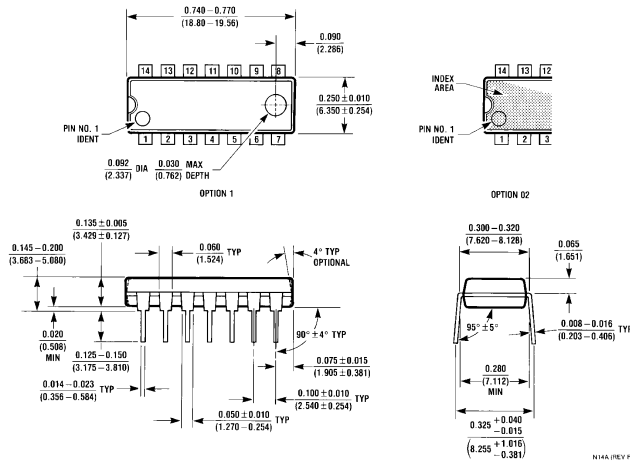

Dual-In-Line Package (N)
Order Number CD4066BMN or CD4066BCN
NS Package Number N14A

LIFE SUPPORT POLICY

NATIONAL'S PRODUCTS ARE NOT AUTHORIZED FOR USE AS CRITICAL COMPONENTS IN LIFE SUPPORT DEVICES OR SYSTEMS WITHOUT THE EXPRESS WRITTEN APPROVAL OF THE PRESIDENT OF NATIONAL SEMICONDUCTOR CORPORATION. As used herein:

1. Life support devices or systems are devices or systems which, (a) are intended for surgical implant into the body, or (b) support or sustain life, and whose failure to perform, when properly used in accordance with instructions for use provided in the labeling, can be reasonably expected to result in a significant injury to the user.
2. A critical component is any component of a life support device or system whose failure to perform can be reasonably expected to cause the failure of the life support device or system, or to affect its safety or effectiveness.



National Semiconductor Corporation
 1111 West Bardin Road
 Arlington, TX 76017
 Tel: 1(800) 272-9959
 Fax: 1(800) 737-7018

National Semiconductor Europe
 Fax: (+49) 0-180-530 85 86
 Email: cnjwge@tevm2.nsc.com
 Deutsch Tel: (+49) 0-180-530 85 85
 English Tel: (+49) 0-180-532 78 32
 Français Tel: (+49) 0-180-532 93 58
 Italiano Tel: (+49) 0-180-534 16 80

National Semiconductor Hong Kong Ltd.
 13th Floor, Straight Block,
 Ocean Centre, 5 Canton Rd.
 Tsimshatsui, Kowloon
 Hong Kong
 Tel: (852) 2737-1600
 Fax: (852) 2736-9960

National Semiconductor Japan Ltd.
 Tel: 81-043-299-2309
 Fax: 81-043-299-2408

National does not assume any responsibility for use of any circuitry described, no circuit patent licenses are implied and National reserves the right at any time without notice to change said circuitry and specifications.