

# OKI Semiconductor

This version: Apr. 1999

## MD56V62320

**4-Bank × 524,288-Word × 32-Bit SYNCHRONOUS DYNAMIC RAM**

### DESCRIPTION

The MD56V62320 is a 4-bank × 524,288-word × 32-bit synchronous dynamic RAM, fabricated in Oki's CMOS silicon-gate process technology. The device operates at 3.3 V. The inputs and outputs are LVTTL compatible.

### FEATURES

- Silicon gate, quadruple polysilicon CMOS, 1-transistor memory cell
- 4-bank × 524,288-word × 32-bit configuration
- 3.3 V power supply, ±0.3 V tolerance
- Input : LVTTL compatible
- Output : LVTTL compatible
- Refresh : 4096 cycles/64 ms
- Programmable data transfer mode
  - $\overline{\text{CAS}}$  latency (2, 3)
  - Burst length (2, 4, 8)
  - Data scramble (sequential, interleave)
- CBR auto-refresh, Self-refresh capability
- Package:
  - 86-pin 400 mil plastic TSOP (Type II) (TSOPII86-P-400-0.50-K) (Product : MD56V62320-xxTA)
  - xx indicates speed rank.

### PRODUCT FAMILY

Family	Max. Frequency	Access Time (Max.)	
		t <sub>AC2</sub>	t <sub>AC3</sub>
MD56V62320-10	100 MHz	9 ns	9 ns

**PIN CONFIGURATION (TOP VIEW)**

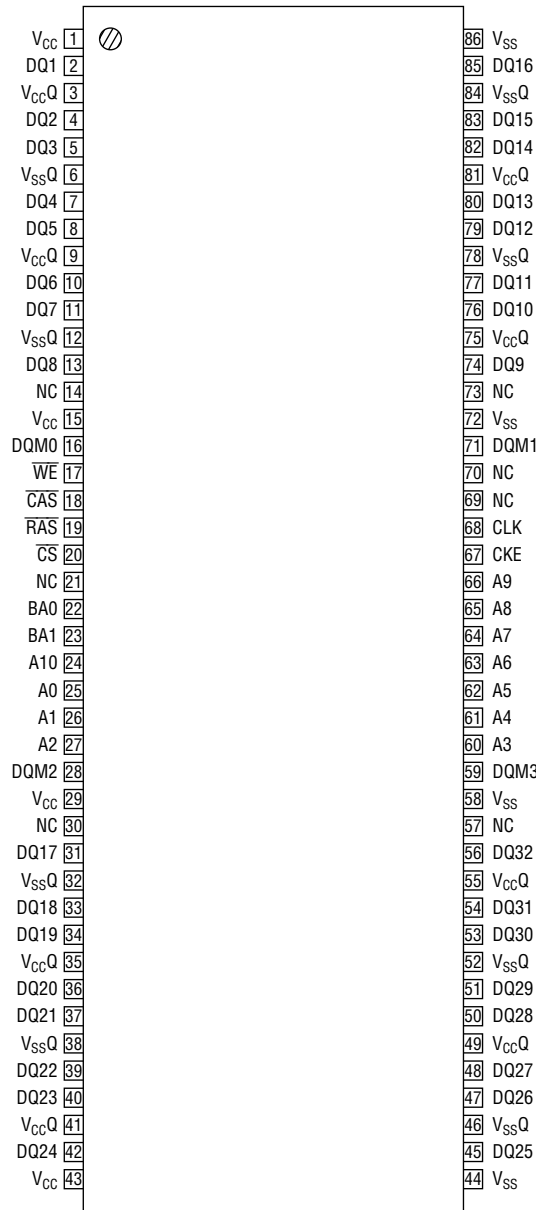

86-Pin Plastic TSOP (II)  
(K Type)

Pin Name	Function	Pin Name	Function
CLK	System Clock	DQM0 - 3	Data Input/Output Mask
$\overline{CS}$	Chip Select	DQi	Data Input/Output
CKE	Clock Enable	V <sub>CC</sub>	Power Supply (3.3 V)
A0 - A10	Address	V <sub>SS</sub>	Ground (0 V)
BA0, BA1	Bank Select Address	V <sub>CCQ</sub>	Data Output Power Supply (3.3 V)
$\overline{RAS}$	Row Address Strobe	V <sub>SSQ</sub>	Data Output Ground (0 V)
$\overline{CAS}$	Column Address Strobe	NC	No Connection
$\overline{WE}$	Write Enable		

Note: The same power supply voltage must be provided to every V<sub>CC</sub> pin and V<sub>CCQ</sub> pin. The same GND voltage level must be provided to every V<sub>SS</sub> pin and V<sub>SSQ</sub> pin.

**PIN DESCRIPTION**

CLK	Fetches all inputs at the "H" edge.
$\overline{\text{CS}}$	Disables or enables device operation by asserting or deactivating all inputs except CLK, CKE, DQM0 - 3.
CKE	Masks system clock to deactivate the subsequent CLK operation. If CKE is deactivated, system clock will be masked so that the subsequent CLK operation is deactivated. CKE should be asserted at least one cycle prior to a new command.
Address	Row & column multiplexed. Row address: RA0 - RA10 Column address: CA0 - CA7
BA0, BA1	Bank Access pins. These pins are dedicated to select one of 4 banks.
$\overline{\text{RAS}}$ $\overline{\text{CAS}}$ $\overline{\text{WE}}$	Functionality depends on the combination. For details, see the function truth table.
DQM0 - 3	DQM0 controls DQ1 - 8. DQM1 controls DQ9 - 16. DQM2 controls DQ17 - 24. DQM3 controls DQ25 - 32.
DQi	Data inputs/outputs are multiplexed on the same pin.

**BLOCK DIAGRAM**

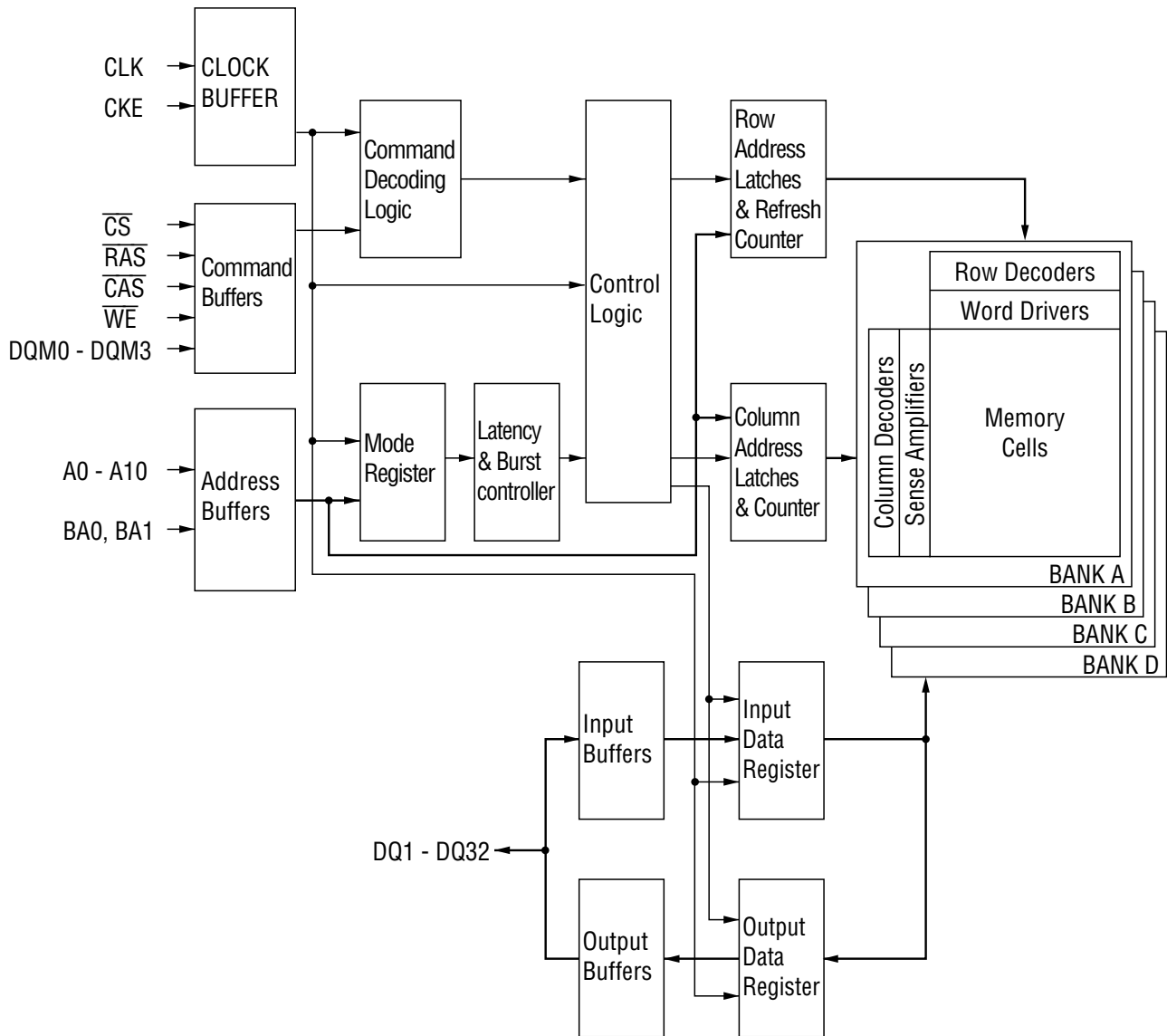

## ELECTRICAL CHARACTERISTICS

### Absolute Maximum Ratings

(Voltages referenced to  $V_{SS}$ )

Parameter	Symbol	Rating	Unit
Voltage on Any Pin Relative to $V_{SS}$	$V_{IN}, V_{OUT}$	$-0.5$ to $V_{CC} + 0.5$	V
$V_{CC}$ Supply Voltage	$V_{CC}, V_{CCQ}$	$-0.5$ to $4.6$	V
Storage Temperature	$T_{stg}$	$-55$ to $150$	$^{\circ}C$
Power Dissipation	$P_D^*$	1	W
Short Circuit Current	$I_{OS}$	50	mA
Operating Temperature	$T_{opr}$	0 to 70	$^{\circ}C$

\*:  $T_a = 25^{\circ}C$ 

### Recommended Operating Conditions

(Voltages referenced to  $V_{SS} = 0$  V)

Parameter	Symbol	Min.	Typ.	Max.	Unit
Power Supply Voltage	$V_{CC}, V_{CCQ}$	3.0	3.3	3.6	V
Input High Voltage	$V_{IH}$	2.0	—	$V_{CC} + 0.3$	V
Input Low Voltage	$V_{IL}$	$-0.3$	—	0.8	V

### Capacitance

 $(V_{CC} = 3.3$  V  $\pm 0.3$  V,  $T_a = 25^{\circ}C$ ,  $f = 1$  MHz)

Parameter	Symbol	Min.	Max.	Unit
Input Capacitance (ADDR)	$C_{IN1}$	2	5	pF
Input Capacitance (CLK, CKE, $\overline{CS}$ , $\overline{RAS}$ , $\overline{CAS}$ , $\overline{WE}$ , DQMO - 3)	$C_{IN2}$	2	5	pF
Input/Output Capacitance (DQ1 - DQ32)	$C_{OUT}$	2	7	pF

## DC Characteristics

Parameter	Symbol	Condition		Version		Unit	Note
		CKE	Others	-10			
				Min.	Max.		
Output High Voltage	$V_{OH}$	—	$I_{OH} = -2 \text{ mA}$	2.4	—	V	
Output Low Voltage	$V_{OL}$	—	$I_{OL} = 2 \text{ mA}$	—	0.4	V	
Input Leakage Current	$I_{LI}$	—	—	-10	10	$\mu\text{A}$	
Output Leakage Current	$I_{LO}$	—	—	-10	10	$\mu\text{A}$	
Average Power Supply Current (Operating)	$I_{CC1}$	$CKE \geq V_{IH}$	$t_{CC} = \text{min}$ $t_{RC} = \text{min}$ No Burst	—	170	mA	1, 2
Power Supply Current (Stand by)	$I_{CC2}$	$CKE \geq V_{IH}$	$\frac{t_{CC}}{CS} = \text{min}$ $CS \geq V_{IH}$	—	40	mA	3
Average Power Supply Current (Clock Suspension)	$I_{CC3S}$	$CKE \leq V_{IL}$	$t_{CC} = \text{min}$	—	6	mA	2
Average Power Supply Current (Active Stand by)	$I_{CC3}$	$CKE \geq V_{IH}$	$\frac{t_{CC}}{CS} = \text{min}$ $CS \geq V_{IH}$	—	100	mA	3
Power Supply Current (Burst)	$I_{CC4}$	$CKE \geq V_{IH}$	$t_{CC} = \text{min}$	—	290	mA	1, 2
Power Supply Current (Auto-Refresh)	$I_{CC5}$	$CKE \geq V_{IH}$	$t_{CC} = \text{min}$ $t_{RC} = \text{min}$	—	190	mA	2
Average Power Supply Current (Self-Refresh)	$I_{CC6}$	$CKE \leq V_{IL}$	$t_{CC} = \text{min}$	—	2	mA	
Average Power Supply Current (Power down)	$I_{CC7}$	$CKE \leq V_{IL}$	$t_{CC} = \text{min}$	—	2	mA	

- Notes:
1. Measured with outputs open.
  2. The address and data can be changed once or left unchanged during one cycle.
  3. The address and data can be changed once or left unchanged during two cycles.

### Mode Set Address Keys

CAS Latency				Burst Type		Burst Length				
A6	A5	A4	CL	A3	BT	A2	A1	A0	BT = 0	BT = 1
0	0	0	Reserved	0	Sequential	0	0	0	Reserved	Reserved
0	0	1	Reserved	1	Interleave	0	0	1	2	2
0	1	0	2			0	1	0	4	4
0	1	1	3			0	1	1	8	8
1	0	0	Reserved			1	0	0	Reserved	Reserved
1	0	1	Reserved			1	0	1	Reserved	Reserved
1	1	0	Reserved			1	1	0	Reserved	Reserved
1	1	1	Reserved			1	1	1	Reserved	Reserved

Note: A7, A8, A9, A10, BA1 and BA0 should stay "L" during mode set cycle.

#### POWER ON SEQUENCE

1. With inputs in NOP state, turn on the power supply and start the system clock.
2. After the  $V_{CC}$  voltage has reached the specified level, pause for 200  $\mu$ s or more with the input kept in NOP state.
3. Issue the precharge all bank command.
4. Apply a CBR auto-refresh eight or more times.
5. Enter the mode register setting command.

## AC Characteristics

Note 1, 2

Parameter	Symbol	MD56V62320-10		Unit	Note	
		Min.	Max.			
Clock Cycles Time	CL = 3	t <sub>CC</sub>	10	—	ns	
	CL = 2		15	—	ns	
Access Time from Clock	CL = 3	t <sub>AC</sub>	—	9	ns	3, 4
	CL = 2		—	9	ns	3, 4
Clock "H" Pulse Time	t <sub>CH</sub>	3	—	ns		
Clock "L" Pulse Time	t <sub>CL</sub>	3	—	ns		
Input Setup Time	t <sub>SI</sub>	3	—	ns		
Input Hold Time	t <sub>HI</sub>	1	—	ns		
Output Low Impedance Time from Clock	t <sub>OLZ</sub>	3	—	ns		
Output High Impedance Time from Clock	t <sub>OHZ</sub>	—	8	ns		
Output Hold from Clock	t <sub>OH</sub>	3	—	ns	3	
RAS Cycle Time	t <sub>RC</sub>	90	—	ns		
RAS Precharge Time	t <sub>RP</sub>	30	—	ns		
RAS Active Time	t <sub>RAS</sub>	60	10 <sup>5</sup>	ns		
RAS to CAS Delay Time	t <sub>RCD</sub>	30	—	ns		
Write Recovery Time	t <sub>WR</sub>	15	—	ns		
Write Command Input Time from Output	t <sub>OWD</sub>	2	—	Cycle		
RAS to RAS Bank Active Delay Time	t <sub>RRD</sub>	20	—	ns		
Refresh Time	t <sub>REF</sub>	—	64	ms		
Power-down Exit Set-up Time	t <sub>PDE</sub>	t <sub>SI</sub> + 1 CLK	—	ns		
Input Level Transition Time	t <sub>T</sub>	—	3	ns		
CAS to CAS Delay Time (Min.)	t <sub>CCD</sub>		1	Cycle		
Clock Disable Time from CKE	t <sub>CKE</sub>		1	Cycle		
Data Output High Impedance Time from DQM	t <sub>DOZ</sub>		2	Cycle		
Data Input Mask Time from DQM	t <sub>DOD</sub>		0	Cycle		
Data Input Time from Write Command	t <sub>DWD</sub>		0	Cycle		
Data Output High Impedance Time from Precharge Command	t <sub>ROH</sub>		2	Cycle		
Active Command Input Time from Mode Register Set Command Input (Min.)	t <sub>MRD</sub>		3	Cycle		



- Notes :
1. AC measurements assume that  $t_T = 1$  ns.
  2. The reference level for timing of input signals is 1.4 V.
  3. Output load.

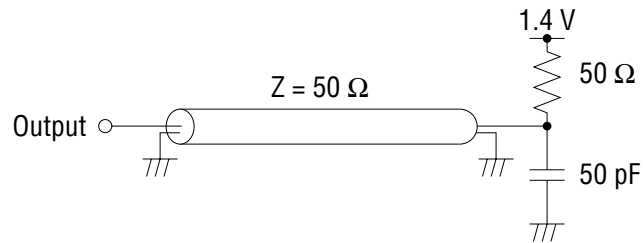

4. The access time is defined at 1.4 V.
5. If  $t_T$  is longer than 1 ns, then the reference level for timing of input signals is  $V_{IH}$  and  $V_{IL}$ .

TIMING WAVEFORM

Read & Write Cycle (Same Bank) @  $\overline{\text{CAS}}$  Latency = 2, Burst Length = 4

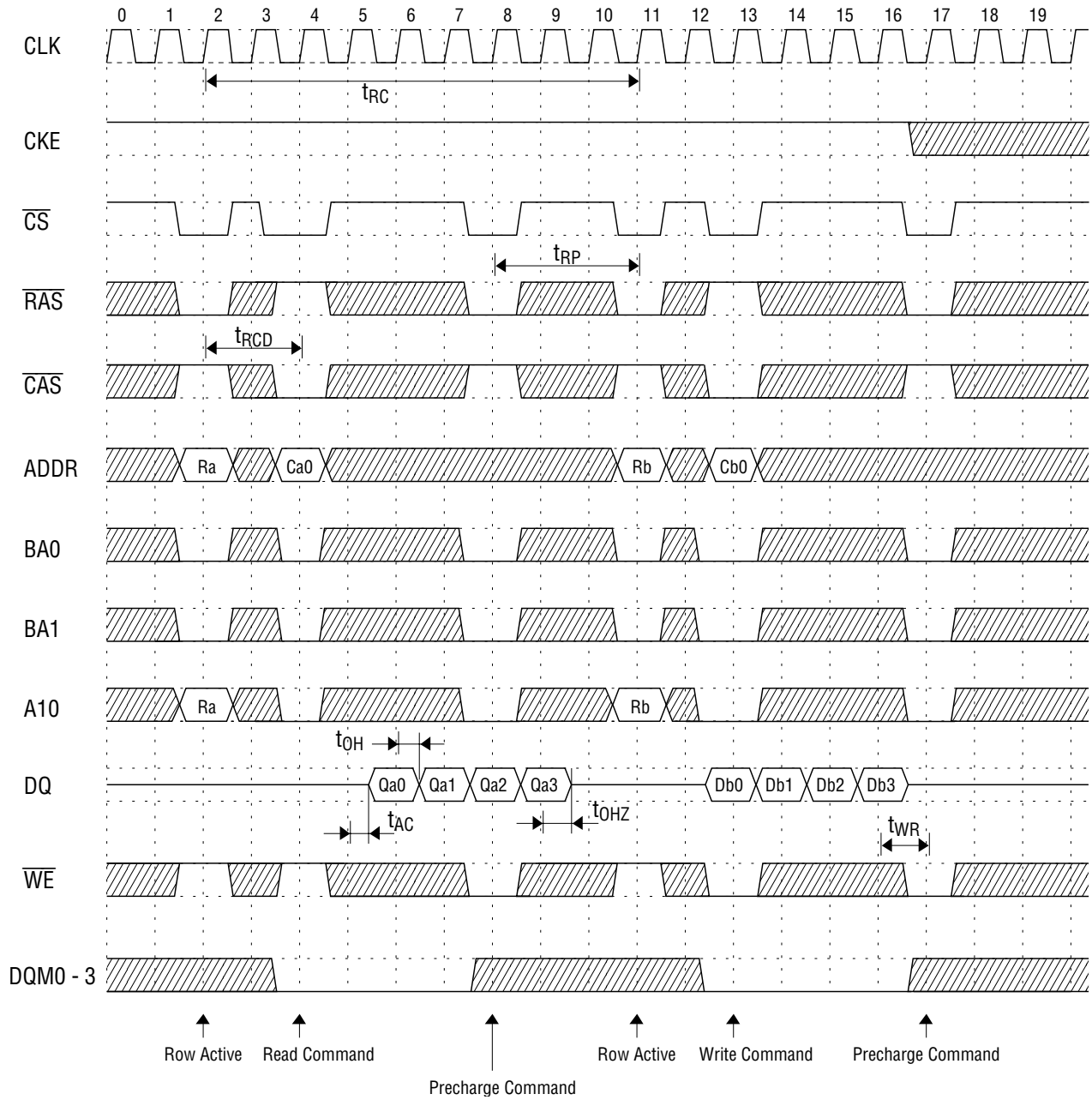

Single Bit Read-Write-Read Cycle (Same Page) @  $\overline{\text{CAS}}$  Latency = 2, Burst Length = 4

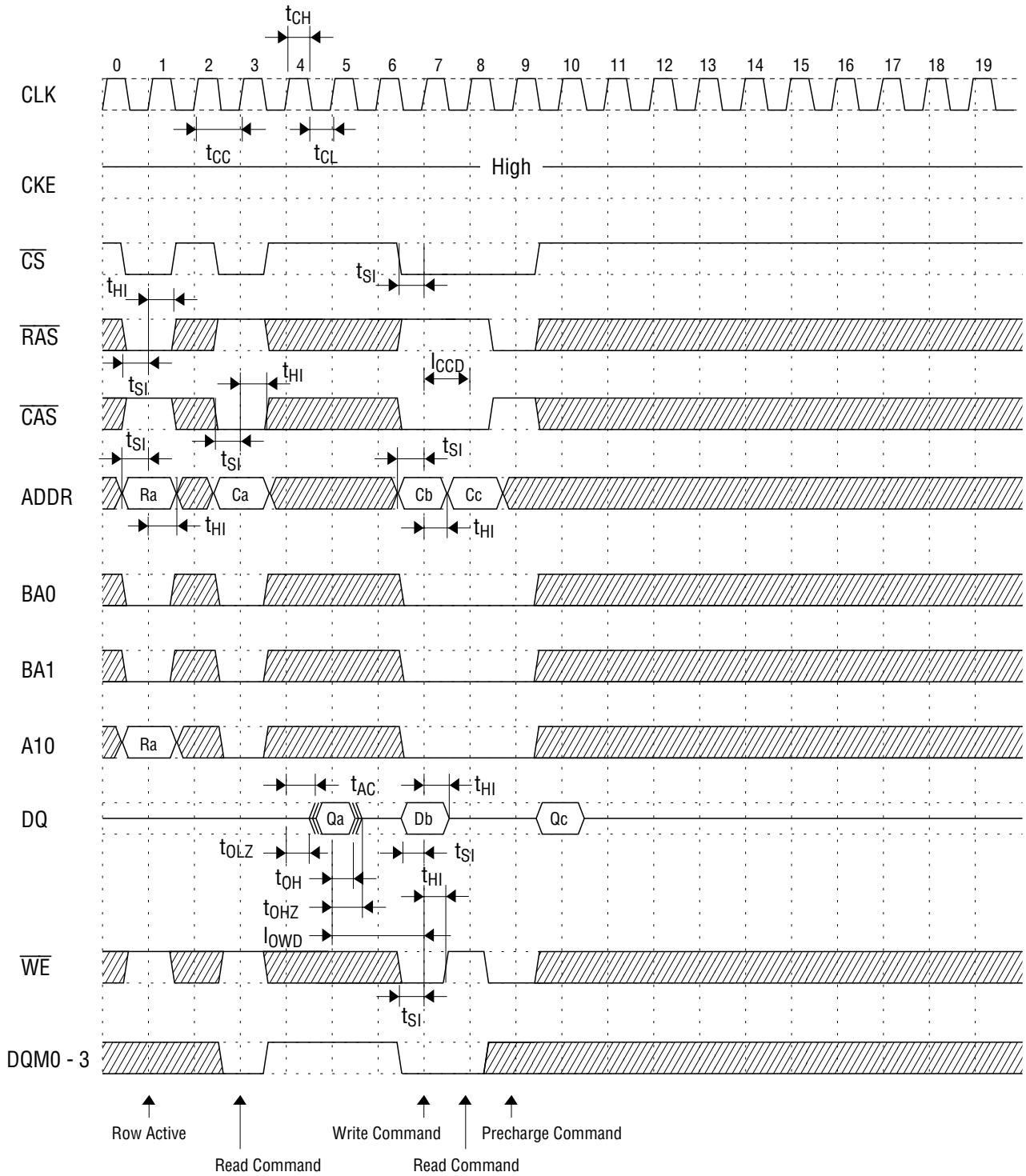

- \*Notes:**
1. When  $\overline{CS}$  is set "High" at a clock transition from "Low" to "High", all inputs except CKE, DQM0 - 3 are invalid.
  2. When issuing an active, read or write command, the bank is selected by BA0 and BA1.

BA1	BA0	Active, read or write
0	0	Bank A
0	1	Bank B
1	0	Bank C
1	1	Bank D

3. The auto precharge function is enabled or disabled by the A10 input when the read or write command is issued.

A10	BA1	BA0	Operation
0	0	0	After the end of burst, bank A holds the idle status.
1	0	0	After the end of burst, bank A is precharged automatically.
0	0	1	After the end of burst, bank B holds the idle status.
1	0	1	After the end of burst, bank B is precharged automatically.
0	1	0	After the end of burst, bank C holds the idle status.
1	1	0	After the end of burst, bank C is precharged automatically.
0	1	1	After the end of burst, bank D holds the idle status.
1	1	1	After the end of burst, bank D is precharged automatically.

4. When issuing a precharge command, the bank to be precharged is selected by the A10, BA1 and BA0 inputs.

A10	BA1	BA0	Operation
0	0	0	Bank A is precharged.
0	0	1	Bank B is precharged.
0	1	0	Bank C is precharged.
0	1	1	Bank D is precharged.
1	X	X	All banks are precharged.

5. The input data and the write command are latched by the same clock (Write latency = 0).
6. The output is forced to high impedance by  $(1 \text{ CLK} + t_{OHZ})$  after DQM0 - 3 entry.

Page Read & Write Cycle (Same Bank) @  $\overline{\text{CAS}}$  Latency = 2, Burst Length = 4

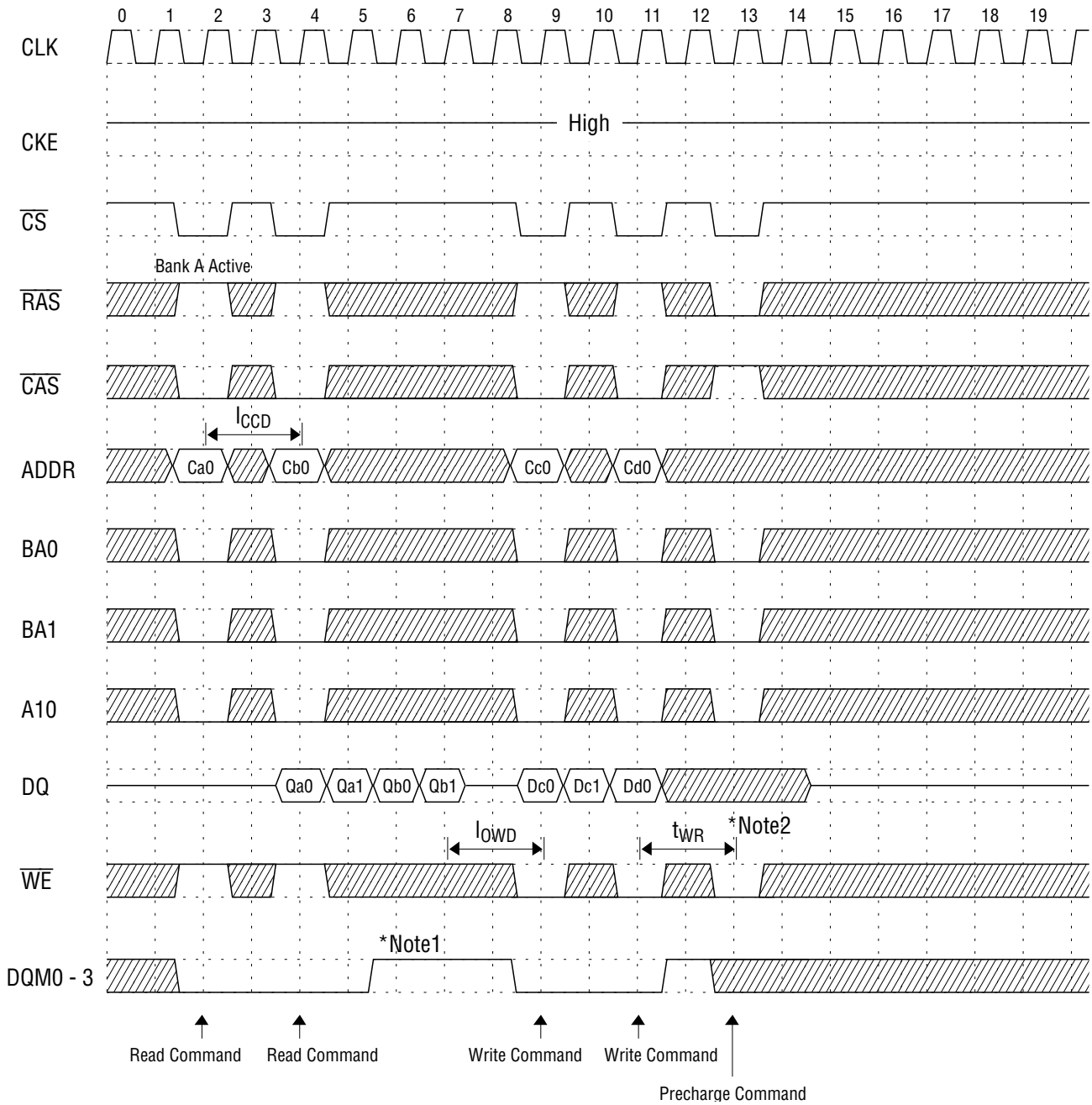

- \*Notes:**
1. To write data before a burst read ends, DQM0 - 3 should be asserted three cycles prior to the write command, to avoid bus contention.
  2. To assert row precharge before a burst write ends, wait  $t_{WR}$  after the last write data input. Input data during the precharge input cycle will be masked internally.

Read & Write Cycle with Auto Precharge @ Burst Length = 4

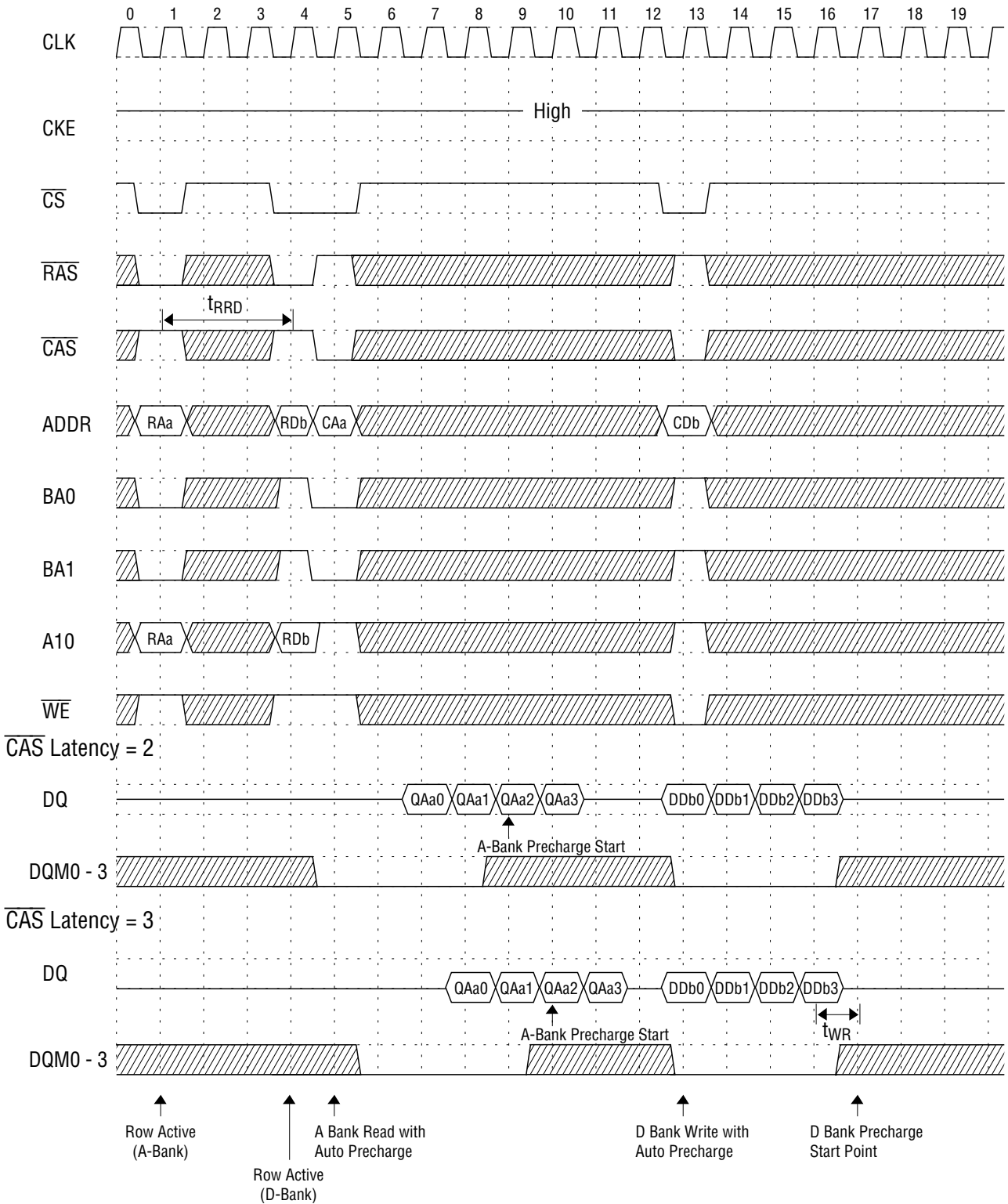

**Bank Interleave Random Row Read Cycle @  $\overline{\text{CAS}}$  Latency = 2, Burst Length = 4**

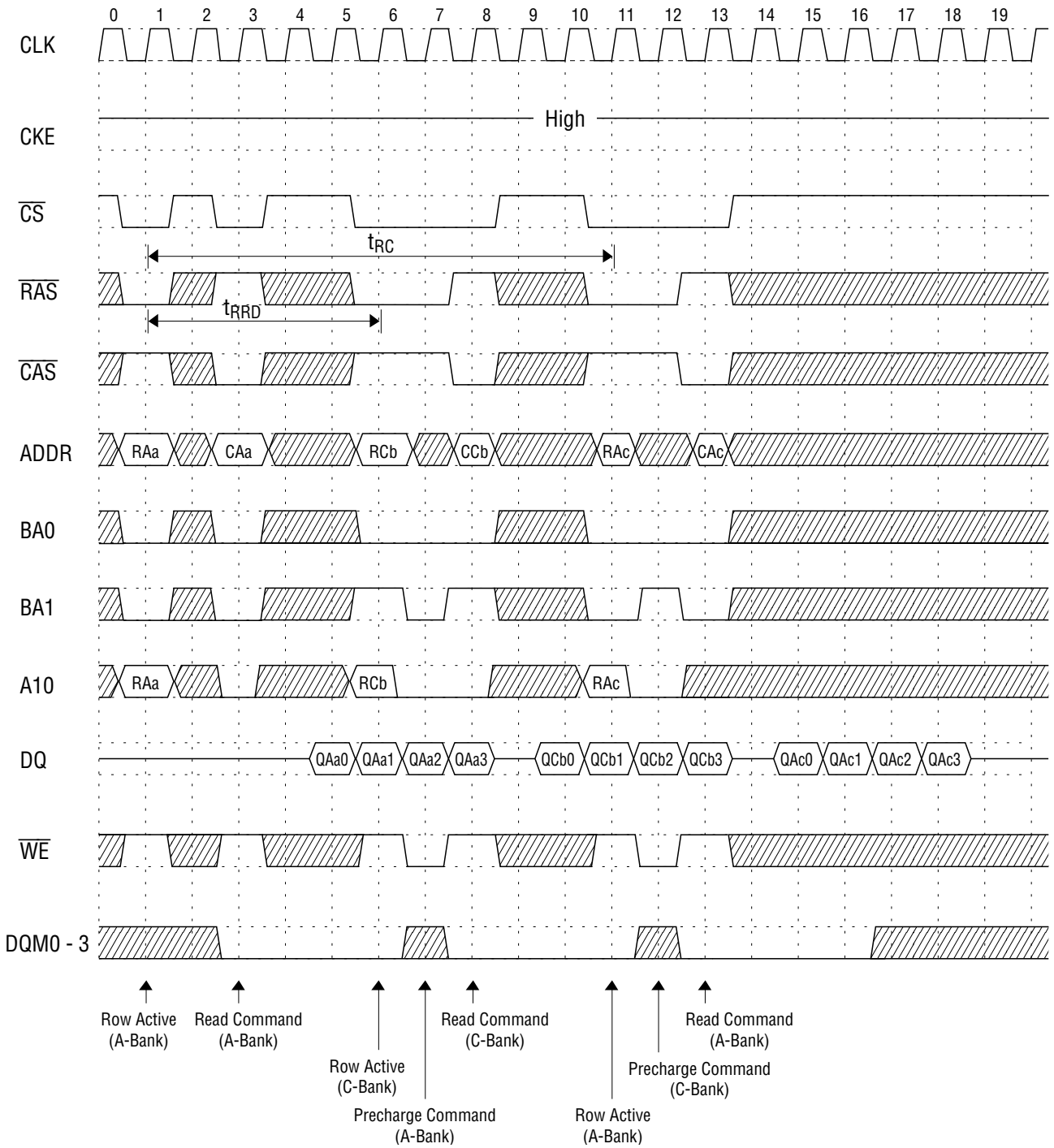

**Bank Interleave Random Row Write Cycle @  $\overline{\text{CAS}}$  Latency = 2, Burst Length = 4**

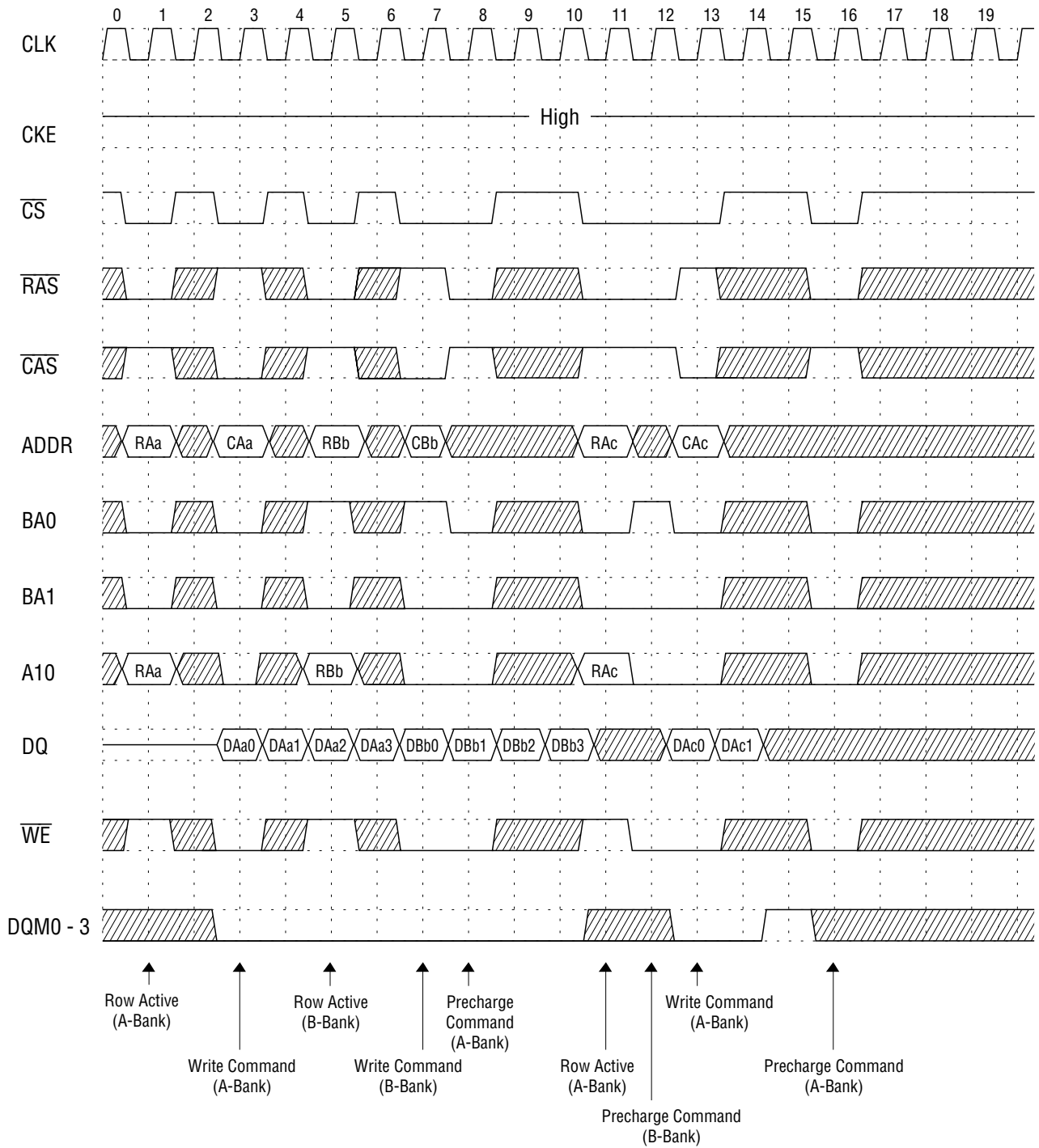



**Bank Interleave Page Read Cycle @  $\overline{\text{CAS}}$  Latency = 2, Burst Length = 4**

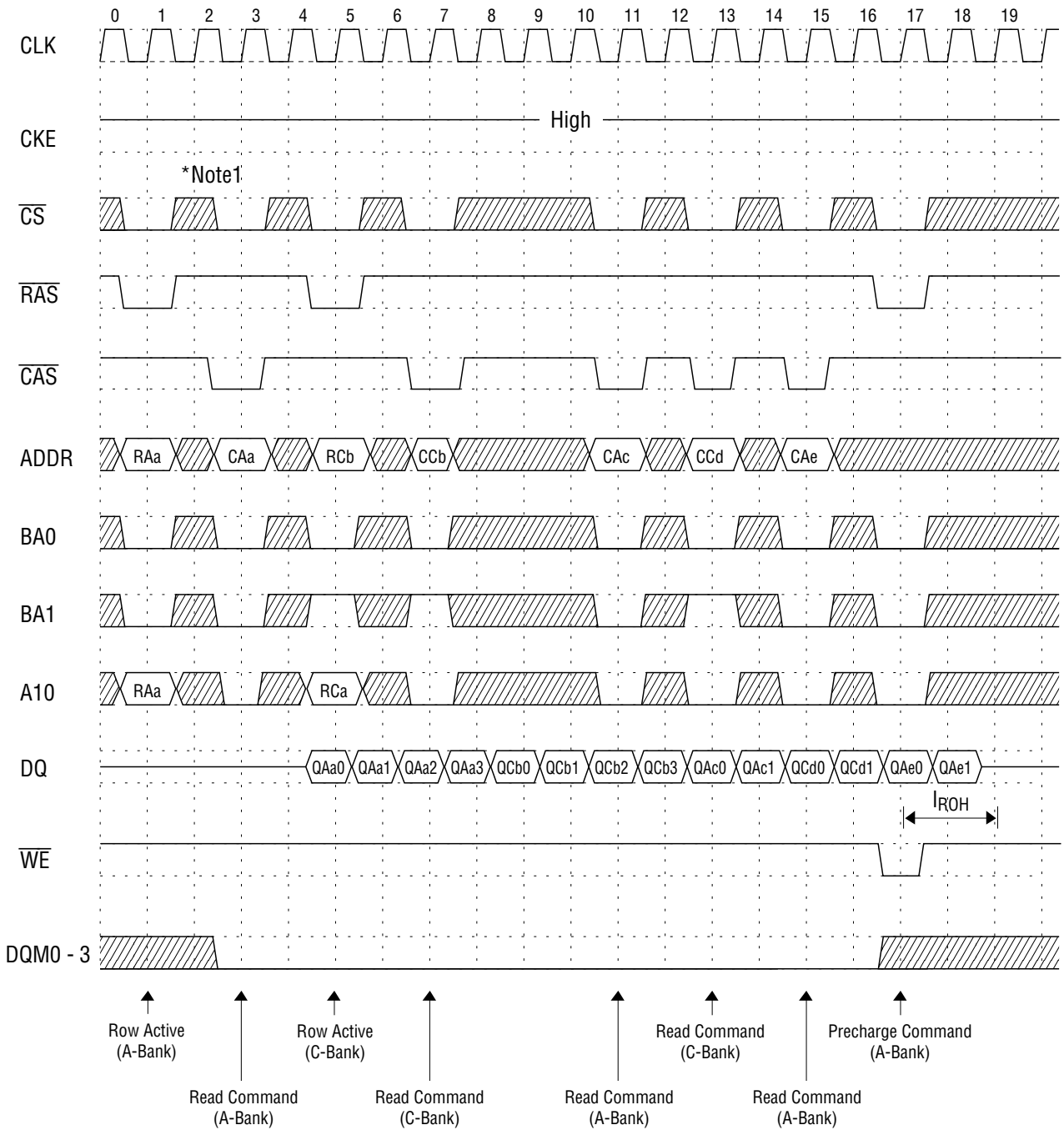

**Bank Interleave Page Write Cycle @  $\overline{\text{CAS}}$  Latency = 2, Burst Length = 4**

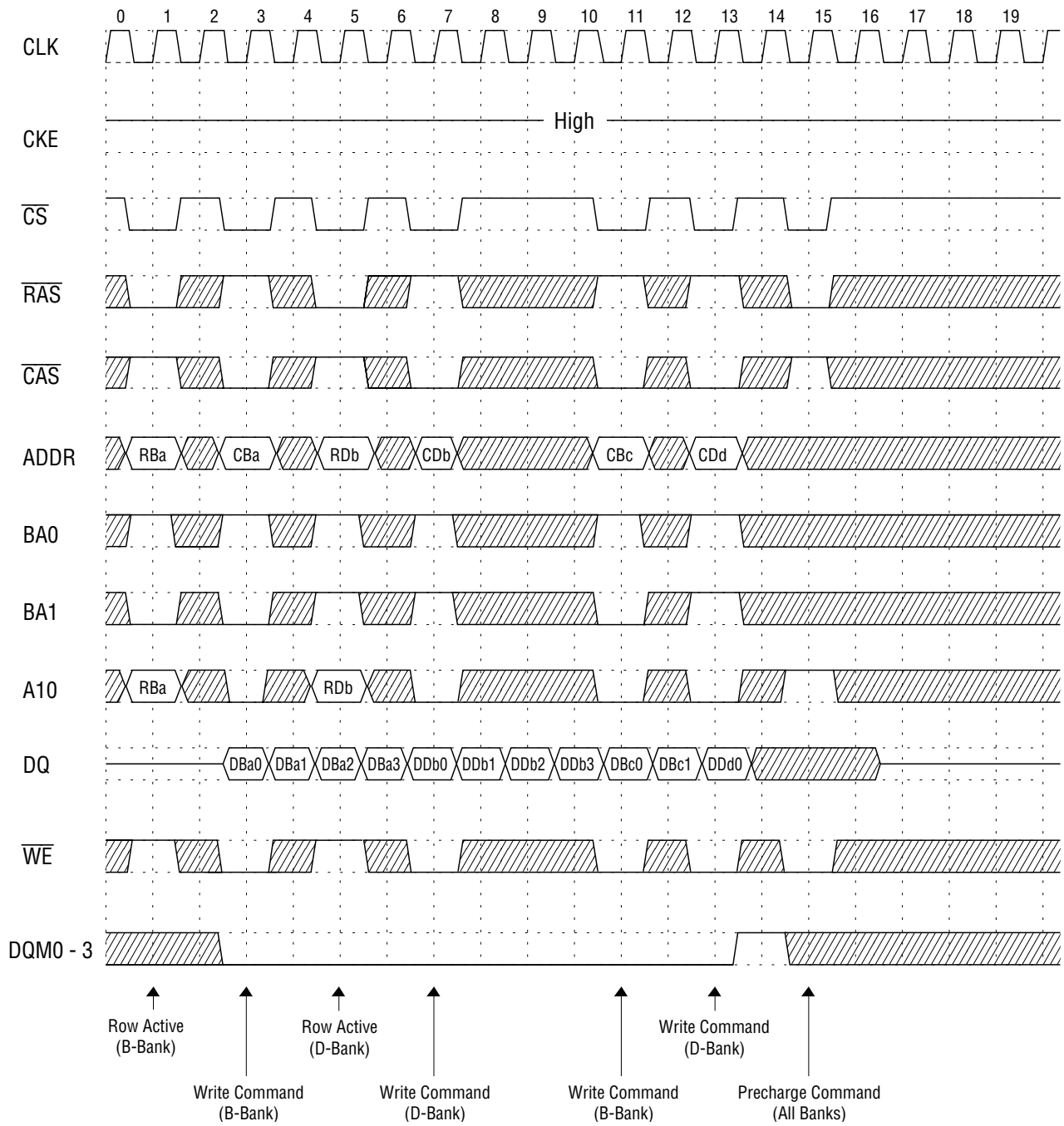

**Bank Interleave Random Row Read/Write Cycle @  $\overline{\text{CAS}}$  Latency = 2, Burst Length = 4**

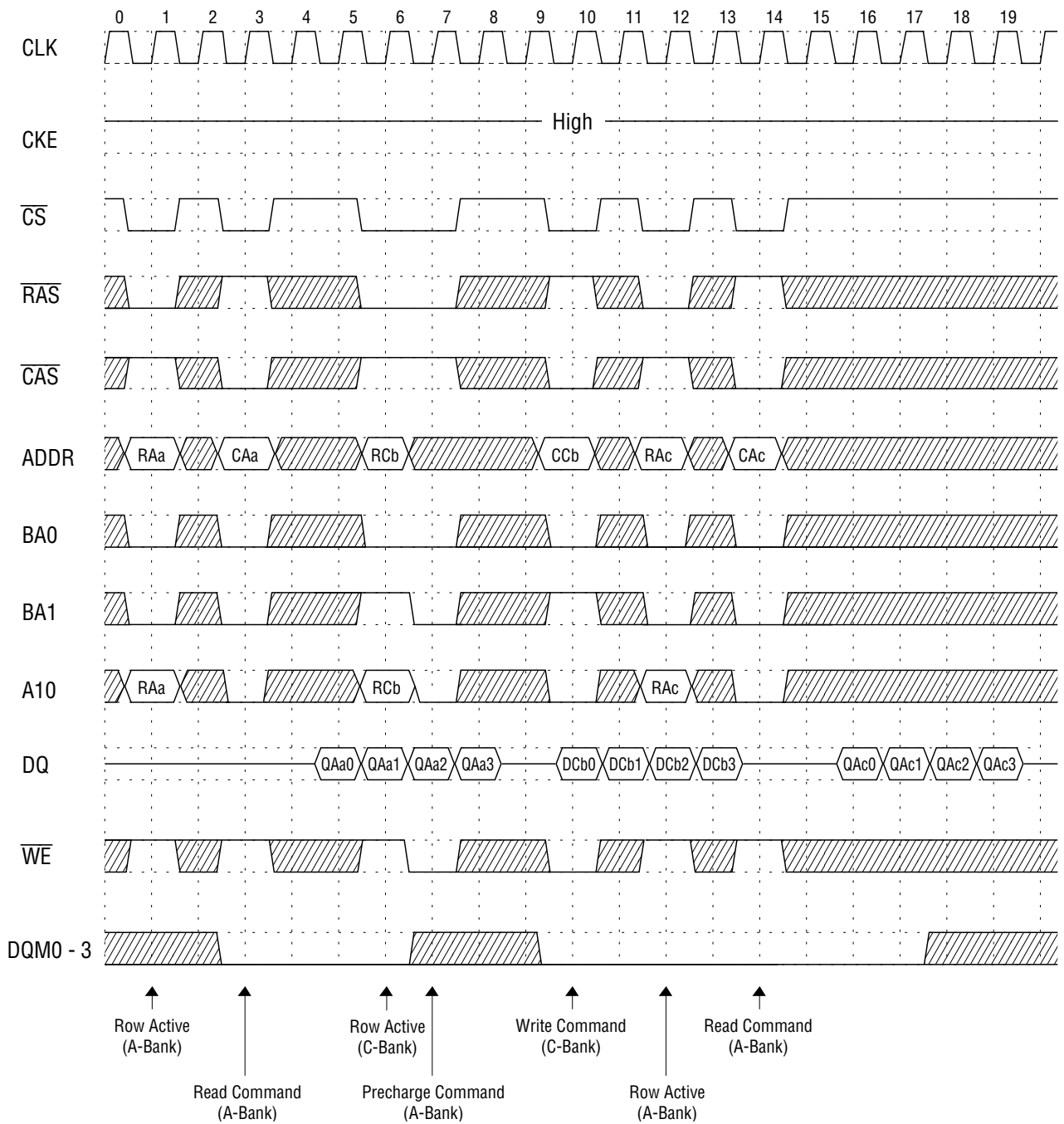

**Bank Interleave Page Read/Write Cycle @  $\overline{\text{CAS}}$  Latency = 2, Burst Length = 4**

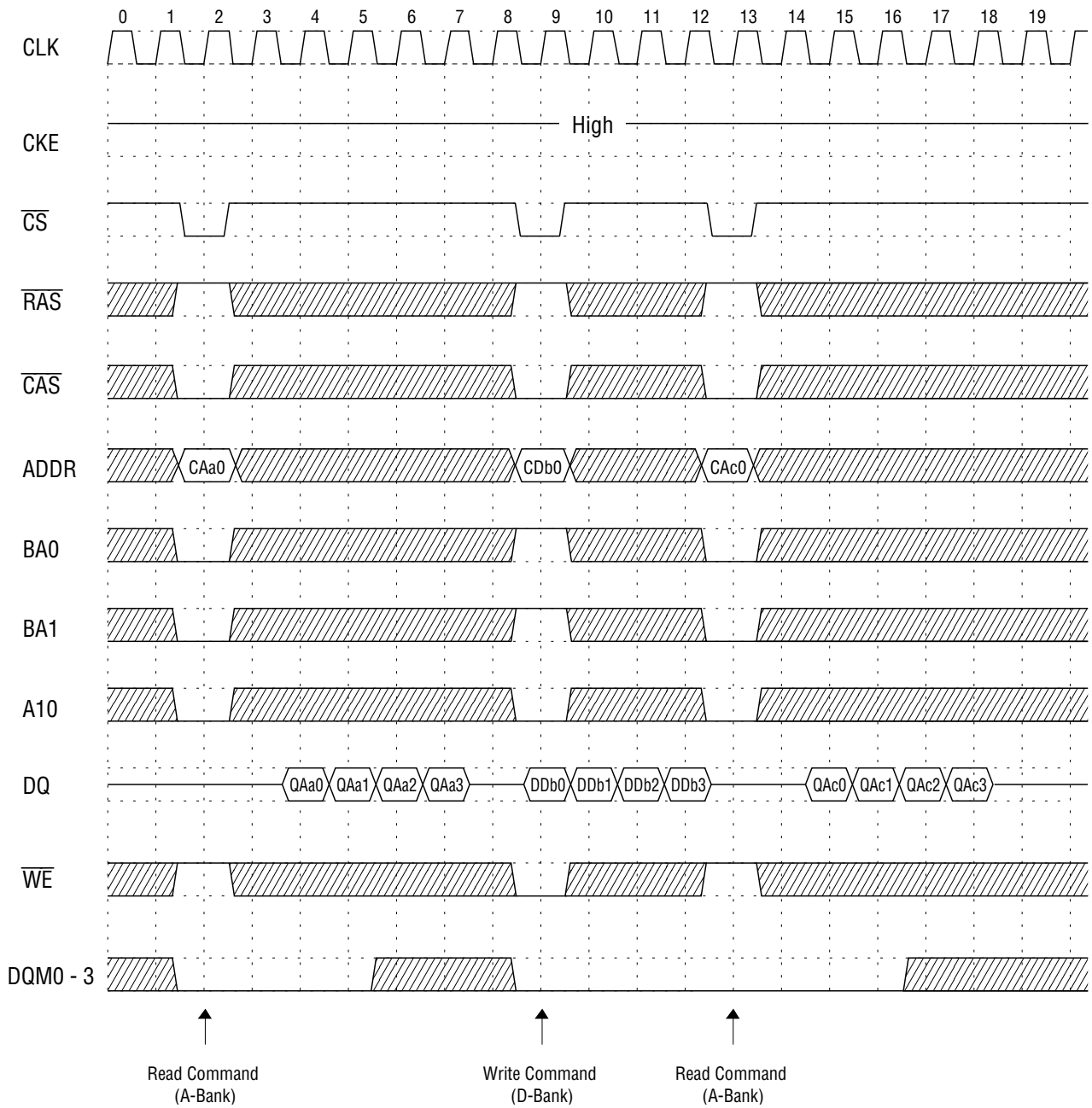

**Clock Suspension & DQM Operation Cycle @  $\overline{\text{CAS}}$  Latency = 2, Burst Length = 4**

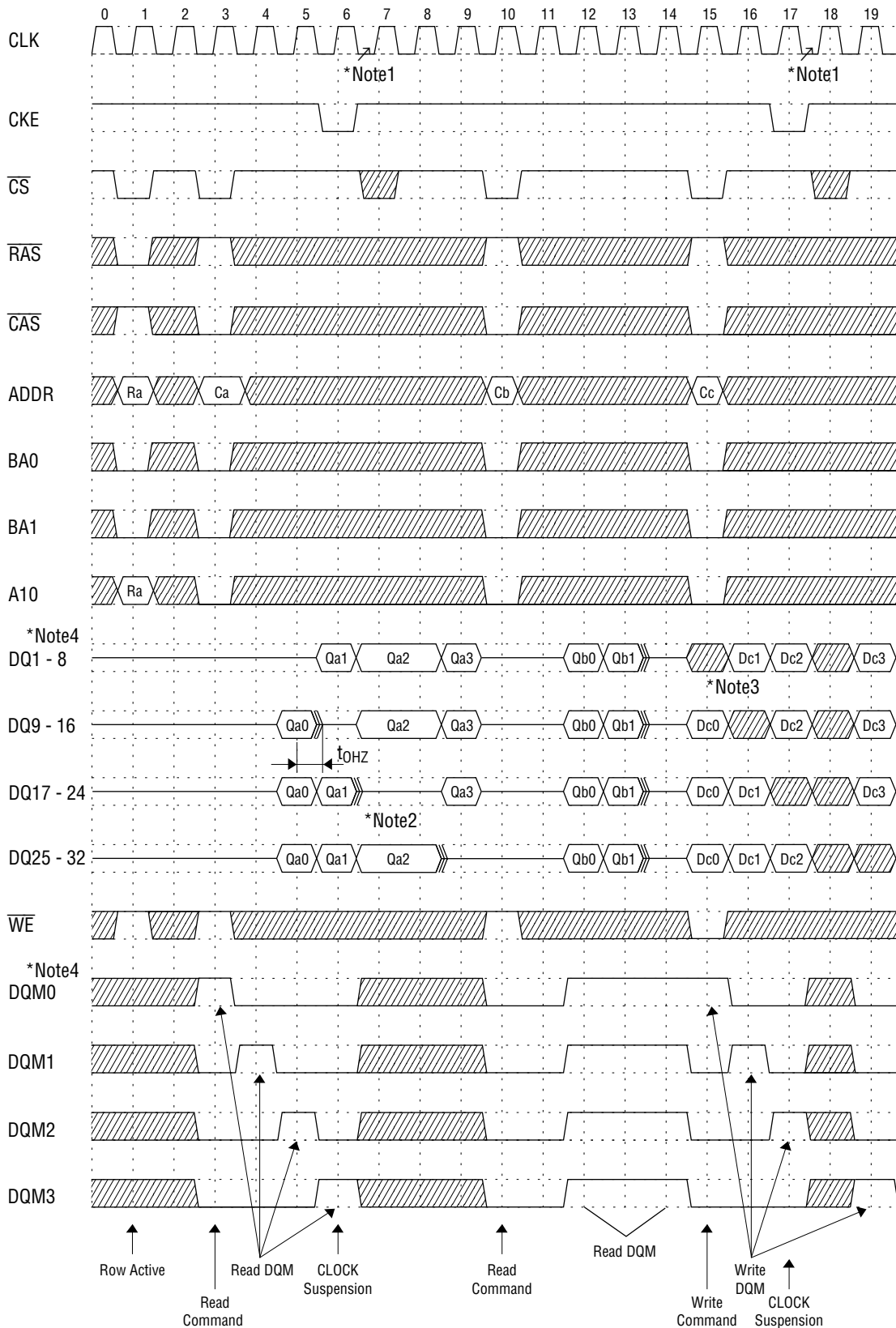

- \*Notes:**
1. When CKE is deactivated, the next clock will be ignored.
  2. When DQM0 - 3 are asserted, the read data after two clock cycles will be masked.
  3. When DQM0 - 3 are asserted, the write data in the same clock cycles will be masked.
  4. When DQM0 is set High, the input/output data of DQ1 - DQ8 will be masked.  
 When DQM1 is set High, the input/output data of DQ9 - DQ16 will be masked.  
 When DQM2 is set High, the input/output data of DQ17 - DQ24 will be masked.  
 When DQM3 is set High, the input/output data of DQ25 - DQ32 will be masked.

Read Interruption by Precharge Command @ Burst Length = 8

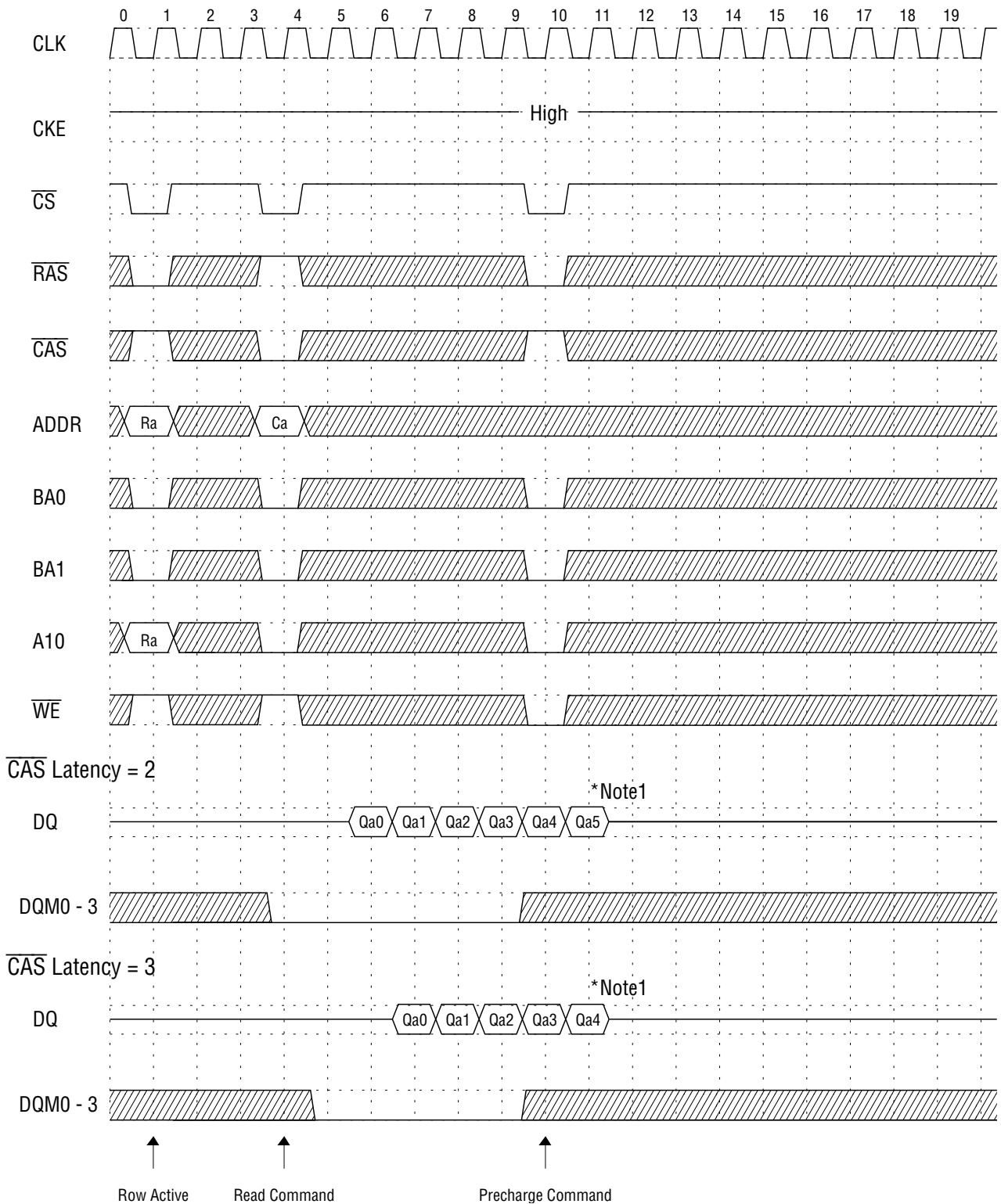

**\*Note:** 1. If row precharge is asserted before burst read ends, then the read data will not output after the second clock cycle of the precharge command.

**Power Down Mode @  $\overline{\text{CAS}}$  Latency = 2, Burst Length = 4**

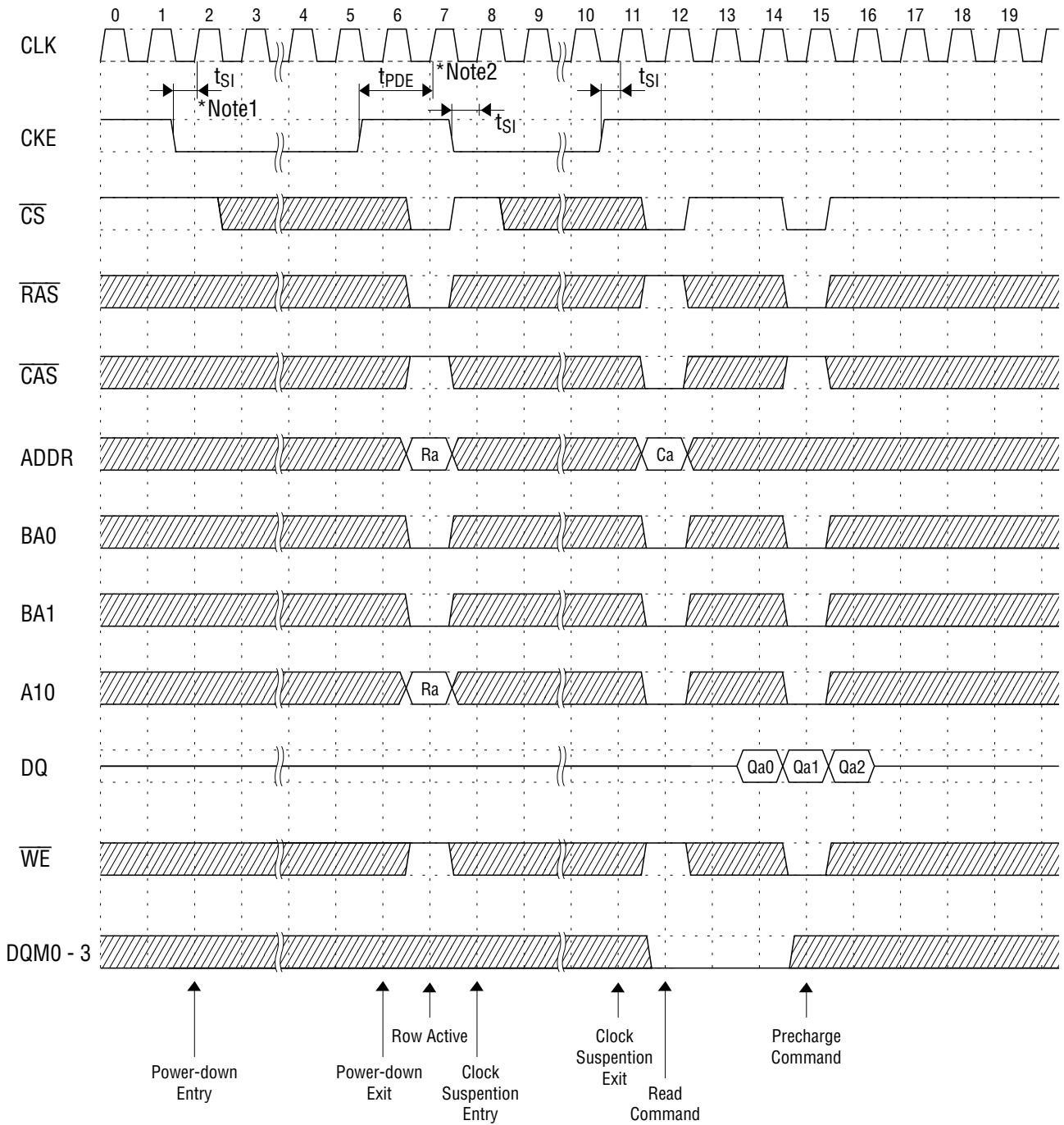

- \*Notes:**
1. When all banks are in precharge state, and if CKE is set low, then the MD56V62320 enters power-down mode and maintains the mode while CKE is low.
  2. To release the circuit from power-down mode, CKE has to be set high for longer than  $t_{PDE} (t_{SI} + 1 \text{ CLK})$ .

Self Refresh Cycle

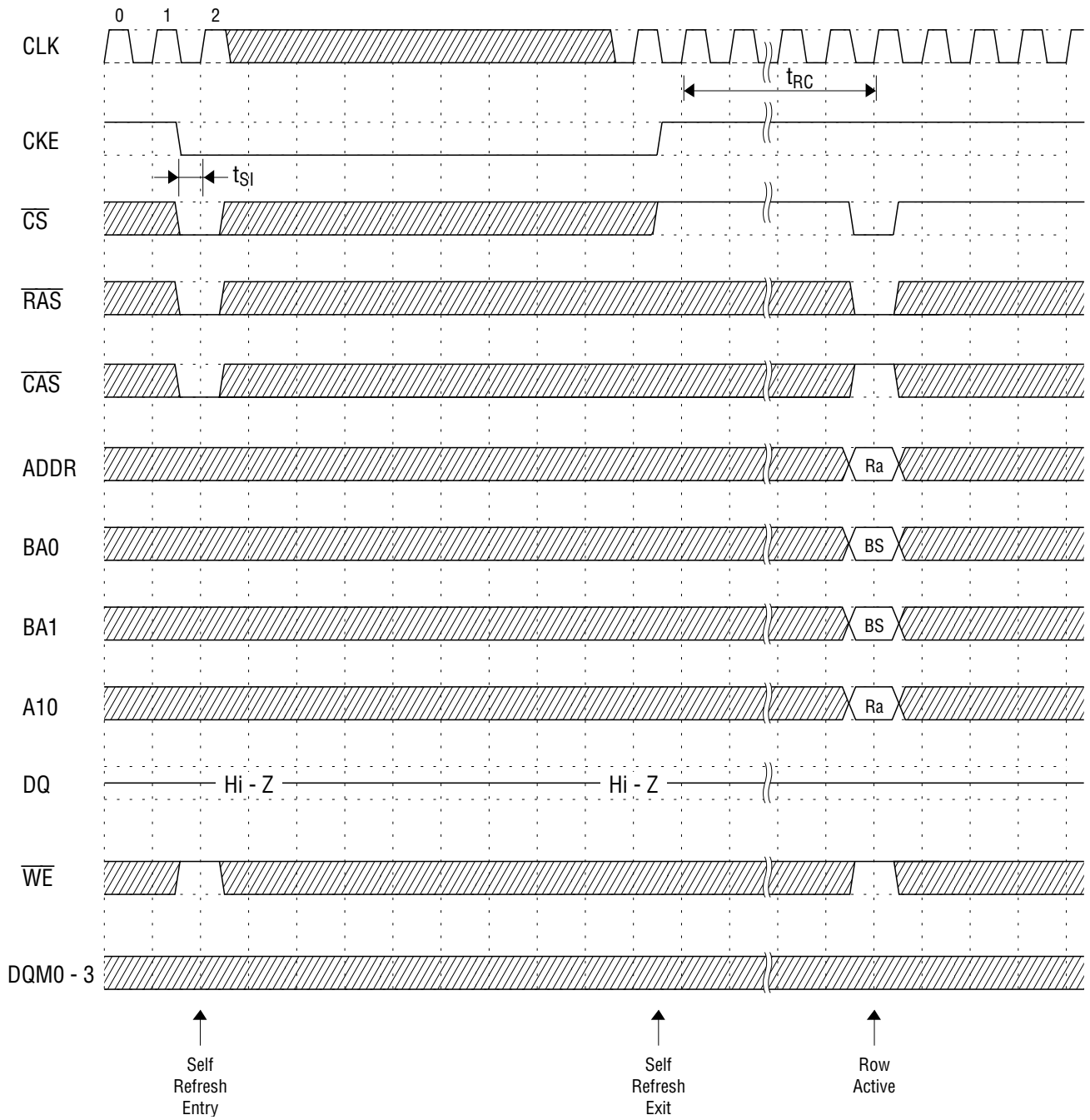



**Mode Register Set Cycle**

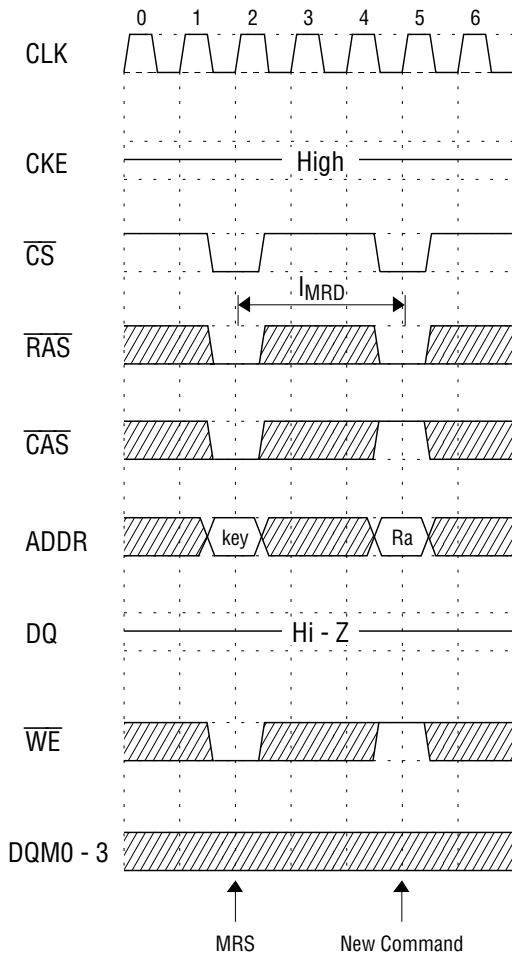

**Auto Refresh Cycle**

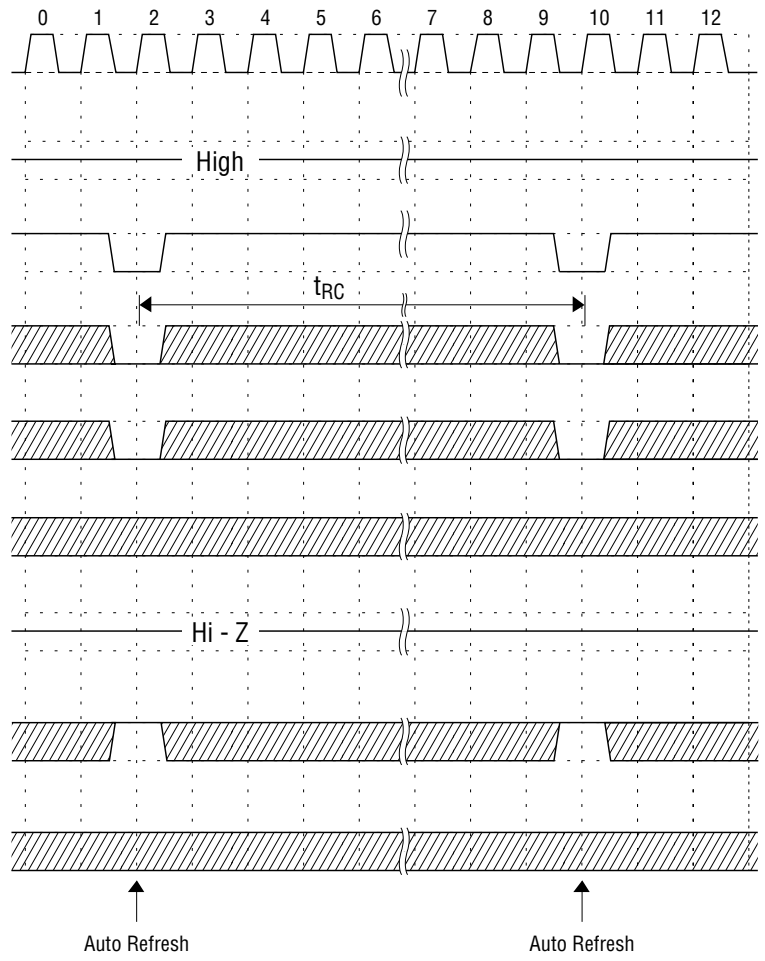

**FUNCTION TRUTH TABLE (Table 1) (1/2)**

Current State <sup>1</sup>	$\overline{CS}$	RAS	$\overline{CAS}$	WE	BA	ADDR	Action
Idle	H	X	X	X	X	X	NOP
	L	H	H	H	X	X	NOP
	L	H	H	L	BA	X	ILLEGAL <sup>2</sup>
	L	H	L	X	BA	CA	ILLEGAL <sup>2</sup>
	L	L	H	H	BA	RA	Row Active
	L	L	H	L	BA	A10	NOP <sup>4</sup>
	L	L	L	H	X	X	Auto-Refresh or Self-Refresh <sup>5</sup>
	L	L	L	L	L	OP Code	Mode Register Write
Row Active	H	X	X	X	X	X	NOP
	L	H	H	X	X	X	NOP
	L	H	L	H	BA	CA, A10	Read
	L	H	L	L	BA	CA, A10	Write
	L	L	H	H	BA	RA	ILLEGAL <sup>2</sup>
	L	L	H	L	BA	A10	Precharge
	L	L	L	X	X	X	ILLEGAL
Read	H	X	X	X	X	X	NOP (Continue Row Active after Burst ends)
	L	H	H	H	X	X	NOP (Continue Row Active after Burst ends)
	L	H	H	L	BA	X	Reserved
	L	H	L	H	BA	CA, A10	Term Burst, start new Burst Read
	L	H	L	L	BA	CA, A10	Term Burst, start new Burst Write
	L	L	H	H	BA	RA	ILLEGAL <sup>2</sup>
	L	L	H	L	BA	A10	Term Burst, execute Row Precharge
	L	L	L	X	X	X	ILLEGAL
Write	H	X	X	X	X	X	NOP (Continue Row Active after Burst ends)
	L	H	H	H	X	X	NOP (Continue Row Active after Burst ends)
	L	H	H	L	BA	X	Reserved (Term Burst) --> Row Active
	L	H	L	H	BA	CA, A10	Term Burst, start new Burst Read
	L	H	L	L	BA	CA, A10	Term Burst, start new Burst Write
	L	L	H	H	BA	RA	ILLEGAL <sup>2</sup>
	L	L	H	L	BA	A10	Term Burst, execute Row Precharge
	L	L	L	X	X	X	ILLEGAL
Read with Auto Precharge	H	X	X	X	X	X	NOP (Continue Burst to End and enter Row Precharge)
	L	H	H	H	X	X	NOP (Continue Burst to End and enter Row Precharge)
	L	H	H	L	BA	X	ILLEGAL <sup>2</sup>
	L	H	L	H	BA	CA, A10	ILLEGAL <sup>2</sup>
	L	H	L	L	X	X	ILLEGAL
	L	L	H	X	BA	RA, A10	ILLEGAL <sup>2</sup>
	L	L	L	X	X	X	ILLEGAL
Write with Auto Precharge	H	X	X	X	X	X	NOP (Continue Burst to End and enter Row Precharge)
	L	H	H	H	X	X	NOP (Continue Burst to End and enter Row Precharge)
	L	H	H	L	BA	X	ILLEGAL <sup>2</sup>
	L	H	L	H	BA	CA, A10	ILLEGAL <sup>2</sup>
	L	H	L	L	X	X	ILLEGAL
	L	L	H	X	BA	RA, A10	ILLEGAL <sup>2</sup>
	L	L	L	X	X	X	ILLEGAL

## FUNCTION TRUTH TABLE (Table 1) (2/2)

Current State <sup>1</sup>	CS	RAS	CAS	WE	BA	ADDR	Action
Precharge	H	X	X	X	X	X	NOP --> Idle after t <sub>RP</sub>
	L	H	H	H	X	X	NOP --> Idle after t <sub>RP</sub>
	L	H	H	L	BA	X	ILLEGAL <sup>2</sup>
	L	H	L	X	BA	CA	ILLEGAL <sup>2</sup>
	L	L	H	H	BA	RA	ILLEGAL <sup>2</sup>
	L	L	H	L	BA	A10	NOP <sup>4</sup>
	L	L	L	X	X	X	ILLEGAL
Write Recovery	H	X	X	X	X	X	NOP
	L	H	H	H	X	X	NOP
	L	H	H	L	BA	X	ILLEGAL <sup>2</sup>
	L	H	L	X	BA	CA	ILLEGAL <sup>2</sup>
	L	L	H	H	BA	RA	ILLEGAL <sup>2</sup>
	L	L	H	L	BA	A10	ILLEGAL <sup>2</sup>
	L	L	L	X	X	X	ILLEGAL
Row Active	H	X	X	X	X	X	NOP --> Row Active after t <sub>RCD</sub>
	L	H	H	H	X	X	NOP --> Row Active after t <sub>RCD</sub>
	L	H	H	L	BA	X	ILLEGAL <sup>2</sup>
	L	H	L	X	BA	CA	ILLEGAL <sup>2</sup>
	L	L	H	H	BA	RA	ILLEGAL <sup>2</sup>
	L	L	H	L	BA	A10	ILLEGAL <sup>2</sup>
	L	L	L	X	X	X	ILLEGAL
Refresh	H	X	X	X	X	X	NOP --> Idle after t <sub>RC</sub>
	L	H	H	X	X	X	NOP --> Idle after t <sub>RC</sub>
	L	H	L	X	X	X	ILLEGAL
	L	L	H	X	X	X	ILLEGAL
	L	L	L	X	X	X	ILLEGAL
Mode Register Access	H	X	X	X	X	X	NOP
	L	H	H	H	X	X	NOP
	L	H	H	L	X	X	ILLEGAL
	L	H	L	X	X	X	ILLEGAL
	L	L	X	X	X	X	ILLEGAL

## ABBREVIATIONS

RA = Row Address

BA = Bank Address

NOP = No Operation command

CA = Column Address

AP = Auto Precharge

- Notes:
1. All inputs are enabled when CKE is set high for at least 1 cycle prior to the inputs.
  2. Illegal to bank in specified state, but may be legal in some cases depending on the state of bank selection.
  3. Satisfy the timing of t<sub>CCD</sub> and t<sub>WR</sub> to prevent bus contention.
  4. NOP to bank precharging or in idle state. Precharges activated bank by BA or A10.
  5. Illegal if any bank is not idle.

## FUNCTION TRUTH TABLE for CKE (Table 2)

Current State (n)	CKEn-1	CKEn	$\overline{CS}$	RAS	CAS	WE	ADDR	Action
Self Refresh	H	X	X	X	X	X	X	INVALID
	L	H	H	X	X	X	X	Exit Self Refresh --> ABI
	L	H	L	H	H	H	X	Exit Self Refresh --> ABI
	L	H	L	H	H	L	X	ILLEGAL
	L	H	L	H	L	X	X	ILLEGAL
	L	H	L	L	X	X	X	ILLEGAL
	L	L	X	X	X	X	X	NOP (Maintain Self Refresh)
Power Down	H	X	X	X	X	X	X	INVALID
	L	H	H	X	X	X	X	Exit Power Down --> ABI
	L	H	L	H	H	H	X	Exit Power Down --> ABI
	L	H	L	H	H	L	X	ILLEGAL
	L	H	L	H	L	X	X	ILLEGAL
	L	H	L	L	X	X	X	ILLEGAL <sup>6</sup>
	L	L	X	X	X	X	X	NOP (Continue power down mode)
All Banks Idle <sup>6</sup> (ABI)	H	H	X	X	X	X	X	Refer to Table 1
	H	L	H	X	X	X	X	Enter Power Down
	H	L	L	H	H	H	X	Enter Power Down
	H	L	L	H	H	L	X	ILLEGAL
	H	L	L	H	L	X	X	ILLEGAL
	H	L	L	L	H	L	X	ILLEGAL
	H	L	L	L	L	H	X	Enter Self Refresh
	H	L	L	L	L	L	X	ILLEGAL
	L	L	X	X	X	X	X	NOP
Any State Other than Listed Above	H	H	X	X	X	X	X	Refer to Operations in Table 1
	H	L	X	X	X	X	X	Begin Clock Suspend Next Cycle
	L	H	X	X	X	X	X	Enable Clock of Next Cycle
	L	L	X	X	X	X	X	Continue Clock Suspension

Note: 6. Power-down and self refresh can be entered only when all the banks are in an idle state.

PACKAGE DIMENSIONS

(Unit : mm)

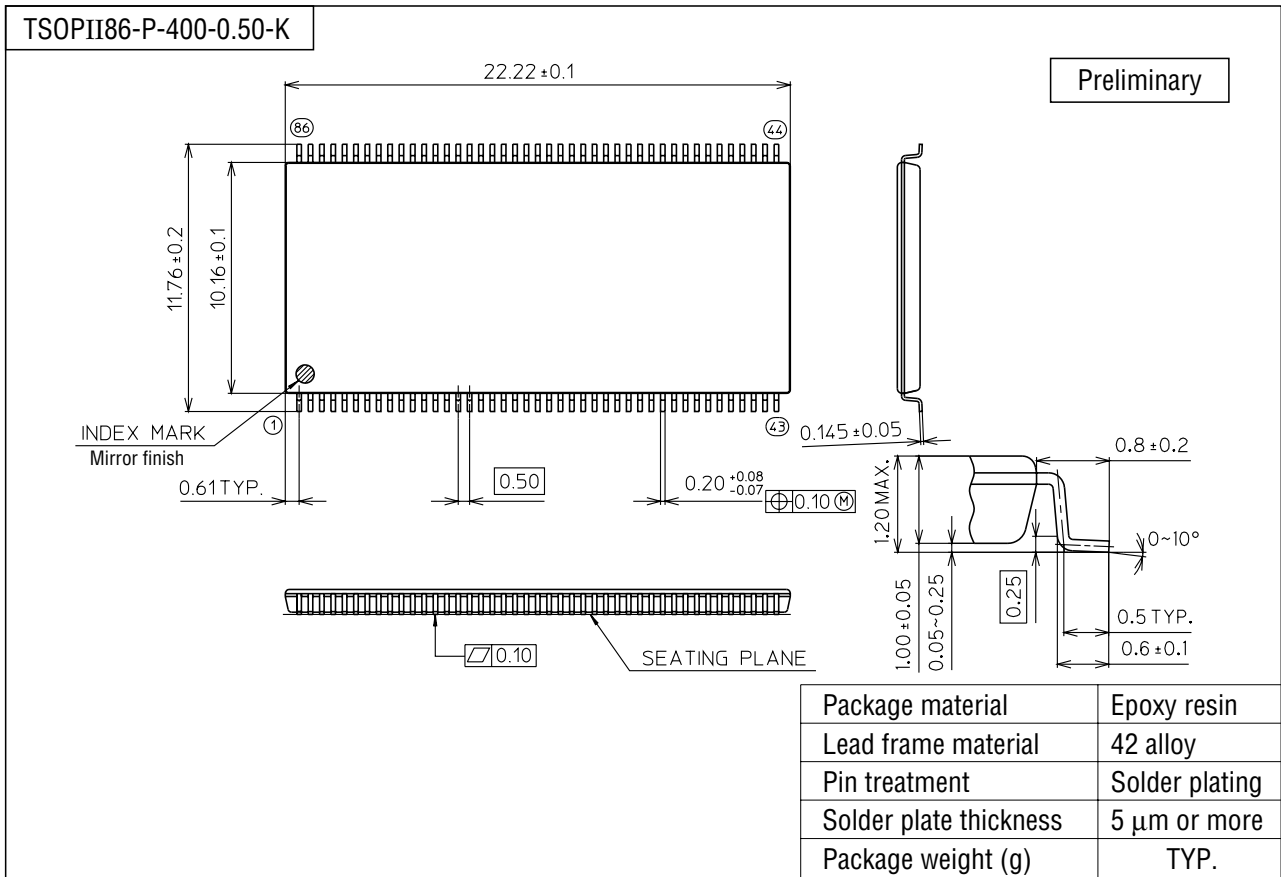

Notes for Mounting the Surface Mount Type Package

The SOP, QFP, TSOP, TQFP, LQFP, SOJ, QFJ (PLCC), SHP, and BGA are surface mount type packages, which are very susceptible to heat in reflow mounting and humidity absorbed in storage. Therefore, before you perform reflow mounting, contact Oki's responsible sales person on the product name, package name, pin number, package code and desired mounting conditions (reflow method, temperature and times).

## NOTICE

1. The information contained herein can change without notice owing to product and/or technical improvements. Before using the product, please make sure that the information being referred to is up-to-date.
2. The outline of action and examples for application circuits described herein have been chosen as an explanation for the standard action and performance of the product. When planning to use the product, please ensure that the external conditions are reflected in the actual circuit, assembly, and program designs.
3. When designing your product, please use our product below the specified maximum ratings and within the specified operating ranges including, but not limited to, operating voltage, power dissipation, and operating temperature.
4. Oki assumes no responsibility or liability whatsoever for any failure or unusual or unexpected operation resulting from misuse, neglect, improper installation, repair, alteration or accident, improper handling, or unusual physical or electrical stress including, but not limited to, exposure to parameters beyond the specified maximum ratings or operation outside the specified operating range.
5. Neither indemnity against nor license of a third party's industrial and intellectual property right, etc. is granted by us in connection with the use of the product and/or the information and drawings contained herein. No responsibility is assumed by us for any infringement of a third party's right which may result from the use thereof.
6. The products listed in this document are intended for use in general electronics equipment for commercial applications (e.g., office automation, communication equipment, measurement equipment, consumer electronics, etc.). These products are not authorized for use in any system or application that requires special or enhanced quality and reliability characteristics nor in any system or application where the failure of such system or application may result in the loss or damage of property, or death or injury to humans. Such applications include, but are not limited to, traffic and automotive equipment, safety devices, aerospace equipment, nuclear power control, medical equipment, and life-support systems.
7. Certain products in this document may need government approval before they can be exported to particular countries. The purchaser assumes the responsibility of determining the legality of export of these products and will take appropriate and necessary steps at their own expense for these.
8. No part of the contents contained herein may be reprinted or reproduced without our prior permission.
9. MS-DOS is a registered trademark of Microsoft Corporation.

Copyright 1999 Oki Electric Industry Co., Ltd.