

**OKI Semiconductor****MSM56V16800D/DH****2-Bank × 1,048,576-Word × 8-Bit SYNCHRONOUS DYNAMIC RAM****DESCRIPTION**

The MSM56V16800D/DH is a 2-bank × 1,048,576-word × 8-bit synchronous dynamic RAM, fabricated in Oki's CMOS silicon-gate process technology. The device operates at 3.3 V. The inputs and outputs are LVTTL compatible.

**FEATURES**

- Silicon gate, quadruple polysilicon CMOS, 1-transistor memory cell
- 2-bank × 1,048,576-word × 8-bit configuration
- 3.3 V power supply, ±0.3 V tolerance
- Input : LVTTL compatible
- Output : LVTTL compatible
- Refresh : 4096 cycles/64 ms
- Programmable data transfer mode
  - $\overline{\text{CAS}}$  latency (1, 2, 3)
  - $\overline{\text{CAS}}$  latency (2, 3)\*<sup>1</sup>
  - Burst length (1, 2, 4, 8, full page)
  - Burst length (1, 2, 4, 8)\*<sup>1</sup>
  - Data scramble (sequential, interleave)
- \*<sup>1</sup> : H version only.
- CBR auto-refresh, Self-refresh capability
- Package:
  - 44-pin 400 mil plastic TSOP (Type II) (TSOPII44-P-400-0.80-K) (Product : MSM56V16800D/DH-xxTS-K)
  - xx indicates speed rank.

**PRODUCT FAMILY**

Family	Max. Frequency	Access Time (Max.)	
		t <sub>AC2</sub>	t <sub>AC3</sub>
MSM56V16800D-10	100 MHz	9 ns	9 ns
MSM56V16800D-12	83 MHz	14 ns	10 ns
MSM56V16800DH-15	66 MHz	9 ns	9 ns

**PIN CONFIGURATION (TOP VIEW)**

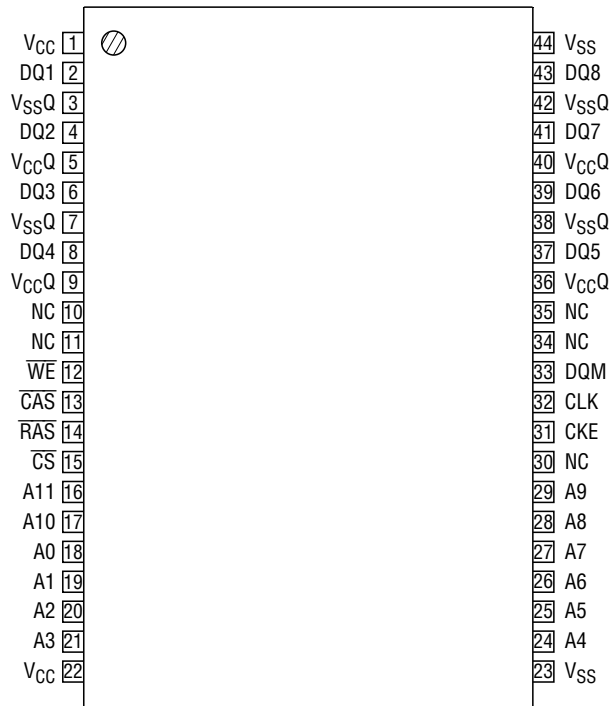

44-Pin Plastic TSOP (II)  
(K Type)

Pin Name	Function	Pin Name	Function
CLK	System Clock	DQM	Data Input/Output Mask
$\overline{CS}$	Chip Select	DQi	Data Input/Output
CKE	Clock Enable	VCC	Power Supply (3.3 V)
A0 - A10	Address	VSS	Ground (0 V)
A11	Bank Select Address	VCCQ	Data Output Power Supply (3.3 V)
$\overline{RAS}$	Row Address Strobe	VSSQ	Data Output Ground (0 V)
$\overline{CAS}$	Column Address Strobe	NC	No Connection
$\overline{WE}$	Write Enable		

Note: The same power supply voltage must be provided to every VCC pin and VCCQ pin. The same GND voltage level must be provided to every VSS pin and VSSQ pin.

**PIN DESCRIPTION**

CLK	Fetches all inputs at the "H" edge.
$\overline{CS}$	Disables or enables device operation by asserting or deactivating all inputs except CLK, CKE and DQM.
CKE	Masks system clock to deactivate the subsequent CLK operation. If CKE is deactivated, system clock will be masked so that the subsequent CLK operation is deactivated. CKE should be asserted at least one cycle prior to a new command.
Address	Row & column multiplexed. Row address: RA0 – RA10 Column address: CA0 – CA8
A11	Selects bank to be activated during row address latch time and selects bank for precharge and read/write during column address latch time. A11 = "L" : Bank A, A11 = "H" : Bank B
$\overline{RAS}$ $\overline{CAS}$ $\overline{WE}$	Functionality depends on the combination. For details, see the function truth table.
DQM	Masks the read data of two clocks later when DQM is set "H" at the "H" edge of the clock signal. Masks the write data of the same clock when DQM is set "H" at the "H" edge of the clock signal.
DQi	Data inputs/outputs are multiplexed on the same pin.

**BLOCK DIAGRAM**

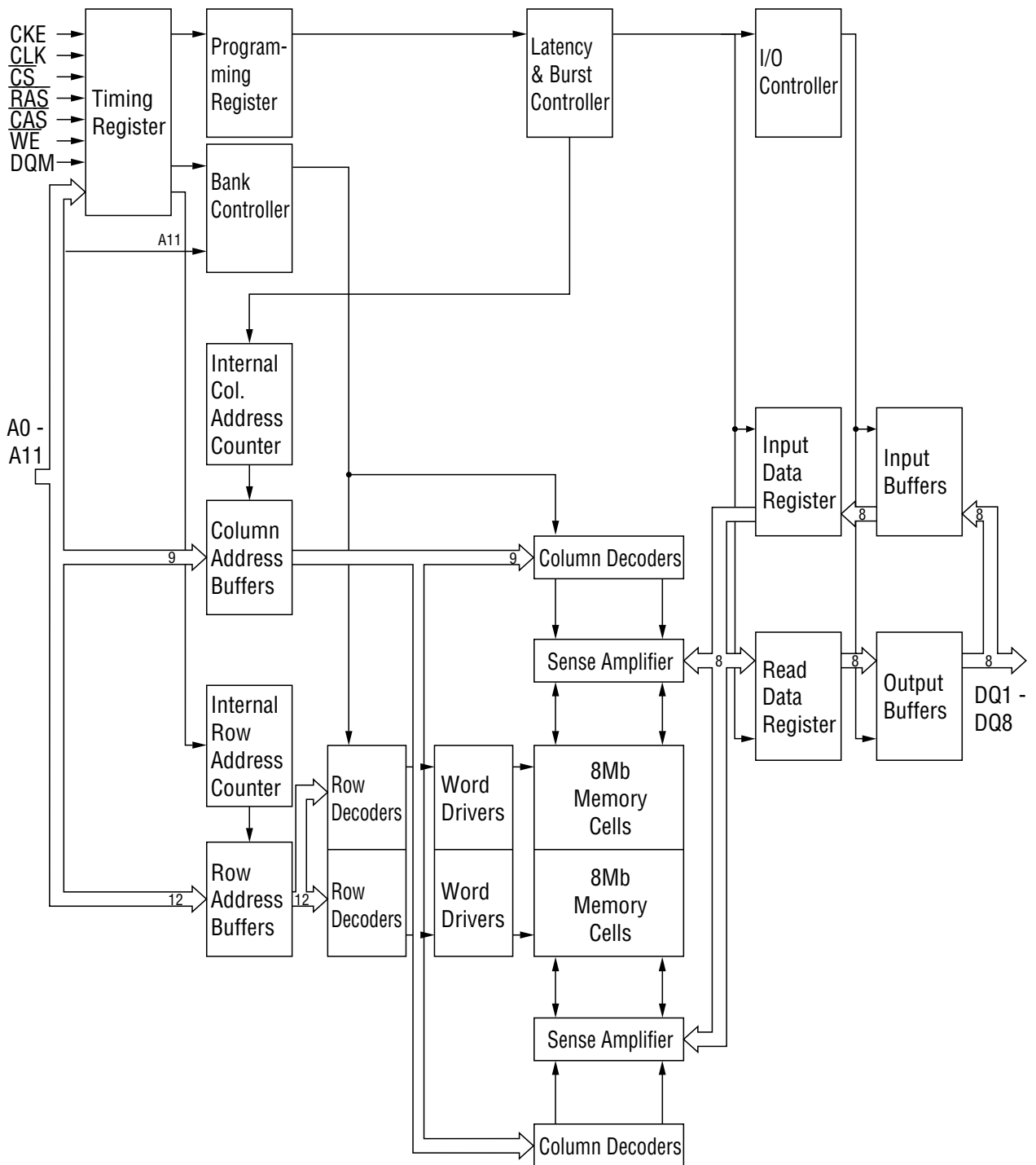

## ELECTRICAL CHARACTERISTICS

### Absolute Maximum Ratings

(Voltages referenced to  $V_{SS}$ )

Parameter	Symbol	Rating	Unit
Voltage on Any Pin Relative to $V_{SS}$	$V_{IN}, V_{OUT}$	-0.5 to $V_{CC} + 0.5$	V
$V_{CC}$ Supply Voltage	$V_{CC}, V_{CCQ}$	-0.5 to 4.6	V
Storage Temperature	$T_{stg}$	-55 to 150	°C
Power Dissipation	$P_D^*$	600	mW
Short Circuit Current	$I_{OS}$	50	mA
Operating Temperature	$T_{opr}$	0 to 70	°C

\*:  $T_a = 25^\circ\text{C}$ 

### Recommended Operating Conditions

(Voltages referenced to  $V_{SS} = 0\text{ V}$ )

Parameter	Symbol	Min.	Typ.	Max.	Unit
Power Supply Voltage	$V_{CC}, V_{CCQ}$	3.0	3.3	3.6	V
Input High Voltage	$V_{IH}$	2.0	—	$V_{CC} + 0.2$	V
Input Low Voltage	$V_{IL}$	-0.3	—	0.8	V

### Capacitance

( $V_{CC} = 3.3\text{ V} \pm 0.3\text{ V}$ ,  $T_a = 25^\circ\text{C}$ ,  $f = 1\text{ MHz}$ )

Parameter	Symbol	Min.	Max.	Unit
Input Capacitance (A0 - A11)	$C_{IN1}$	2	5	pF
Input Capacitance (CLK, CKE, $\overline{CS}$ , $\overline{RAS}$ , $\overline{CAS}$ , $\overline{WE}$ , DQM)	$C_{IN2}$	2	5	pF
Input/Output Capacitance (DQ1 - DQ8)	$C_{OUT}$	2	7	pF

DC Characteristics

Parameter	Symbol	Condition			Version						Unit	Note
		Bank	CKE	Others	D-10		D-12		DH-15			
					Min.	Max.	Min.	Max.	Min.	Max.		
Output High Voltage	V <sub>OH</sub>	—	—	I <sub>OH</sub> = -2 mA	2.4	—	2.4	—	2.4	—	V	
Output Low Voltage	V <sub>OL</sub>	—	—	I <sub>OL</sub> = 2 mA	—	0.4	—	0.4	—	0.4	V	
Input Leakage Current	I <sub>LI</sub>	—	—	—	-10	10	-10	10	-10	10	μA	
Output Leakage Current	I <sub>LO</sub>	—	—	—	-10	10	-10	10	-10	10	μA	
Average Power Supply Current (Operating)	I <sub>CC1</sub>	One Bank Active	CKE ≥ V <sub>IH</sub>	t <sub>CC</sub> = min t <sub>RC</sub> = min No Burst	—	70	—	60	—	55	mA	1, 2
	I <sub>CC1D</sub>	Both Banks Active	CKE ≥ V <sub>IH</sub>	t <sub>CC</sub> = min t <sub>RC</sub> = min t <sub>RDD</sub> = min No Burst	—	100	—	85	—	80	mA	1, 2
Power Supply Current (Stand by)	I <sub>CC2</sub>	Both Banks Precharge	CKE ≥ V <sub>IH</sub>	t <sub>CC</sub> = min	—	30	—	25	—	20	mA	3
Average Power Supply Current (Clock Suspension)	I <sub>CC3S</sub>	Both Banks Active	CKE ≤ V <sub>IL</sub>	t <sub>CC</sub> = min	—	3	—	3	—	3	mA	2
Average Power Supply Current (Active Stand by)	I <sub>CC3</sub>	One Bank Active	CKE ≥ V <sub>IH</sub>	t <sub>CC</sub> = min	—	35	—	30	—	25	mA	3
Power Supply Current (Burst)	I <sub>CC4</sub>	Both Banks Active	CKE ≥ V <sub>IH</sub>	t <sub>CC</sub> = min	—	90	—	75	—	60	mA	1, 2
Power Supply Current (Auto-Refresh)	I <sub>CC5</sub>	One Bank Active	CKE ≥ V <sub>IH</sub>	t <sub>CC</sub> = min t <sub>RC</sub> = min	—	70	—	60	—	50	mA	2
Average Power Supply Current (Self-Refresh)	I <sub>CC6</sub>	Both Banks Precharge	CKE ≤ V <sub>IL</sub>	t <sub>CC</sub> = min	—	2	—	2	—	2	mA	
Average Power Supply Current (Power down)	I <sub>CC7</sub>	Both Banks Precharge	CKE ≤ V <sub>IL</sub>	t <sub>CC</sub> = min	—	2	—	2	—	2	mA	

- Notes:
1. Measured with outputs open.
  2. The address and data can be changed once or left unchanged during one cycle.
  3. The address and data can be changed once or left unchanged during two cycles.

**Mode Set Address Keys**

CAS Latency				Burst Type		Burst Length				
A6	A5	A4	CL	A3	BT	A2	A1	A0	BT = 0	BT = 1
0	0	0	Reserved	0	Sequential	0	0	0	1	1
0	0	1	1*2	1	Interleave	0	0	1	2	2
0	1	0	2			0	1	0	4	4
0	1	1	3			0	1	1	8	8
1	0	0	Reserved			1	0	0	Reserved	Reserved
1	0	1	Reserved			1	0	1	Reserved	Reserved
1	1	0	Reserved			1	1	0	Reserved	Reserved
1	1	1	Reserved			1	1	1	Full Page*2	Reserved

\*2: Not applicable to H version.

Note: A7, A8, A9, A10 and A11 should stay "L" during mode set cycle.

**POWER ON SEQUENCE**

1. With inputs in NOP state, turn on the power supply and start the system clock.
2. After the V<sub>CC</sub> voltage has reached the specified level, pause for 200 μs or more with the input kept in NOP state.
3. Issue the precharge all bank command.
4. Apply a CBR auto-refresh eight or more times.
5. Enter the mode register setting command.

AC Characteristics

Note 1, 2

Parameter		Symbol	MSM56V16800D-10		MSM56V16800D-12		MSM56V16800DH-15		Unit	Note
			Min.	Max.	Min.	Max.	Min.	Max.		
Clock Cycles Time	CL = 3	t <sub>CC</sub>	10	—	12	—	15	—	ns	
	CL = 2		15	—	17.5	—	15	—	ns	
	CL = 1		30	—	35	—	—	—	ns	
Access Time from Clock	CL = 3	t <sub>AC</sub>	—	9	—	10	—	9	ns	3, 4
	CL = 2		—	9	—	14	—	9	ns	3, 4
	CL = 1		—	27	—	30	—	—	ns	3, 4
Clock "H" Pulse Time		t <sub>CH</sub>	3	—	3	—	3	—	ns	
Clock "L" Pulse Time		t <sub>CL</sub>	3	—	3	—	3	—	ns	
Input Setup Time		t <sub>SI</sub>	3	—	3	—	3	—	ns	
Input Hold Time		t <sub>HI</sub>	1	—	1	—	1	—	ns	
Output Low Impedance Time from Clock		t <sub>OLZ</sub>	3	—	3	—	3	—	ns	
Output High Impedance Time from Clock		t <sub>OHZ</sub>	—	8	—	10	—	8	ns	
Output Hold from Clock		t <sub>OH</sub>	3	—	3	—	3	—	ns	3
RAS Cycle Time		t <sub>RC</sub>	100	—	115	—	105	—	ns	
RAS Precharge Time		t <sub>RP</sub>	30	—	35	—	30	—	ns	
RAS Active Time		t <sub>RAS</sub>	60	10 <sup>5</sup>	70	10 <sup>5</sup>	70	10 <sup>5</sup>	ns	
RAS to CAS Delay Time		t <sub>RCD</sub>	30	—	35	—	30	—	ns	
Write Recovery Time		t <sub>WR</sub>	15	—	24	—	15	—	ns	
RAS to RAS Bank Active Delay Time		t <sub>RRD</sub>	20	—	24	—	24	—	ns	
Refresh Time		t <sub>REF</sub>	—	64	—	64	—	64	ms	
Power-down Exit Set-up Time		t <sub>PDE</sub>	t <sub>SI</sub> + 1 CLK	—	t <sub>SI</sub> + 1 CLK	—	t <sub>SI</sub> + 1 CLK	—	ns	
Input Level Transition Time		t <sub>T</sub>	—	3	—	3	—	3	ns	
CAS to CAS Delay Time (Min.)		t <sub>CCD</sub>	1		1		1		Cycle	
Clock Disable Time from CKE		t <sub>CKE</sub>	1		1		1		Cycle	
Data Output High Impedance Time from DQM		t <sub>DOZ</sub>	2		2		2		Cycle	
Data Input Mask Time from DQM		t <sub>DOD</sub>	0		0		0		Cycle	
Data Input Time from Write Command		t <sub>DWD</sub>	0		0		0		Cycle	
Data Output High Impedance Time from Precharge Command	CL = 1	t <sub>ROH</sub>	1		1		—		Cycle	
	CL > 1		2		2		2		Cycle	
Active Command Input Time from Mode Register Set Command Input (Min.)		t <sub>MRD</sub>	3		3		3		Cycle	
Write Command Input Time from Output		t <sub>OWD</sub>	2		2		2		Cycle	



- Notes :
1. AC measurements assume that  $t_T = 1$  ns.
  2. The reference level for timing of input signals is 1.4 V.
  3. Output load.

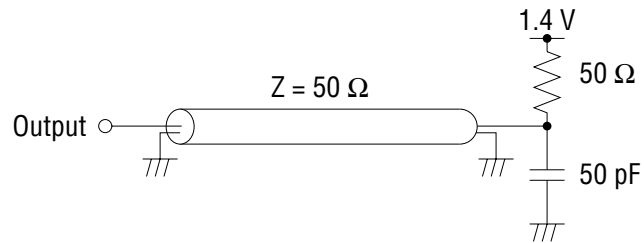

4. The access time is defined at 1.4 V.
5. If  $t_T$  is longer than 1 ns, then the reference level for timing of input signals is  $V_{IH}$  and  $V_{IL}$ .

**TIMING WAVEFORM**

**Read & Write Cycle (Same Bank) @  $\overline{\text{CAS}}$  Latency = 2, Burst Length = 4**

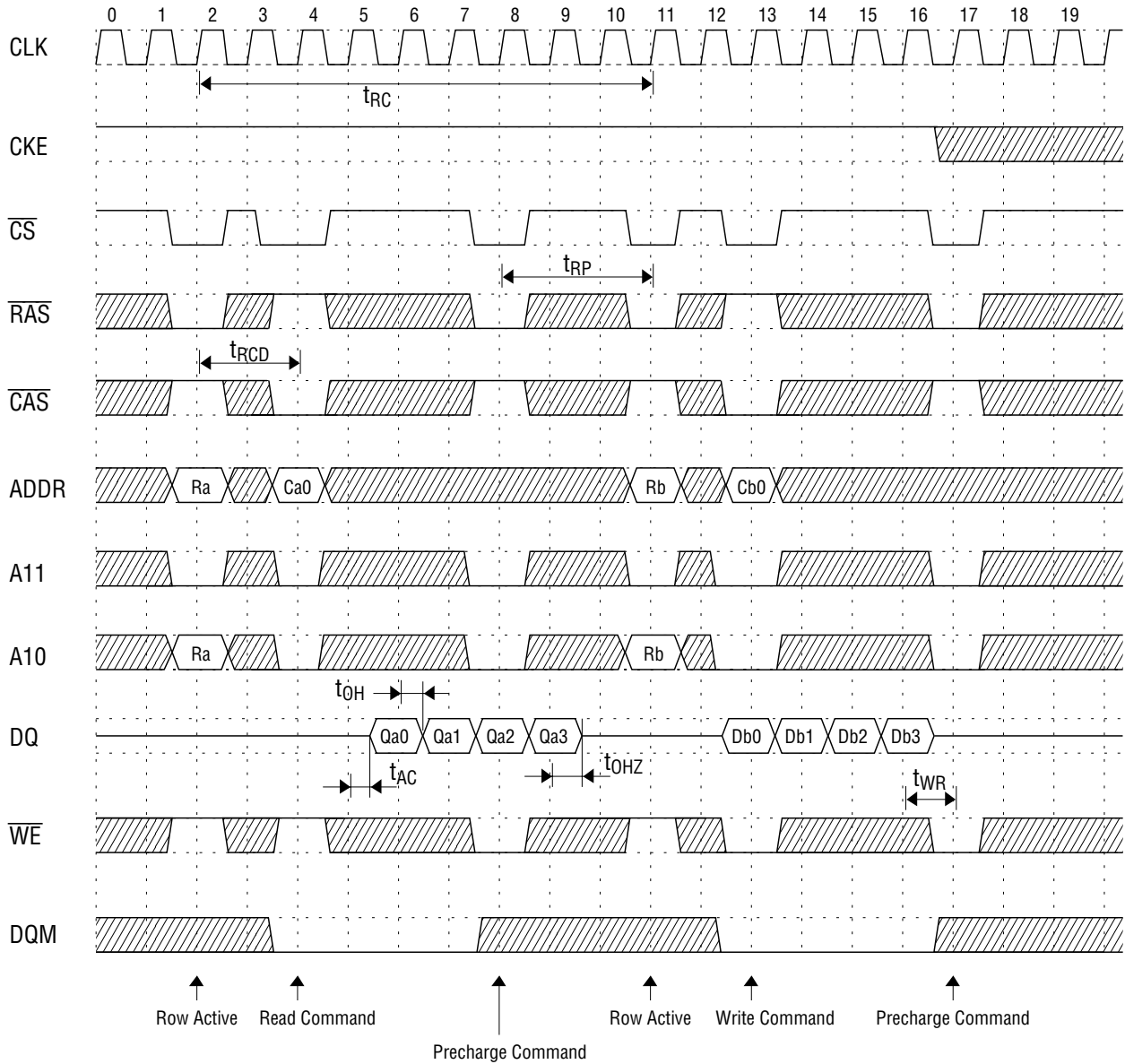

Single Bit Read-Write-Read Cycle (Same Page) @  $\overline{\text{CAS}}$  Latency = 2, Burst Length = 4

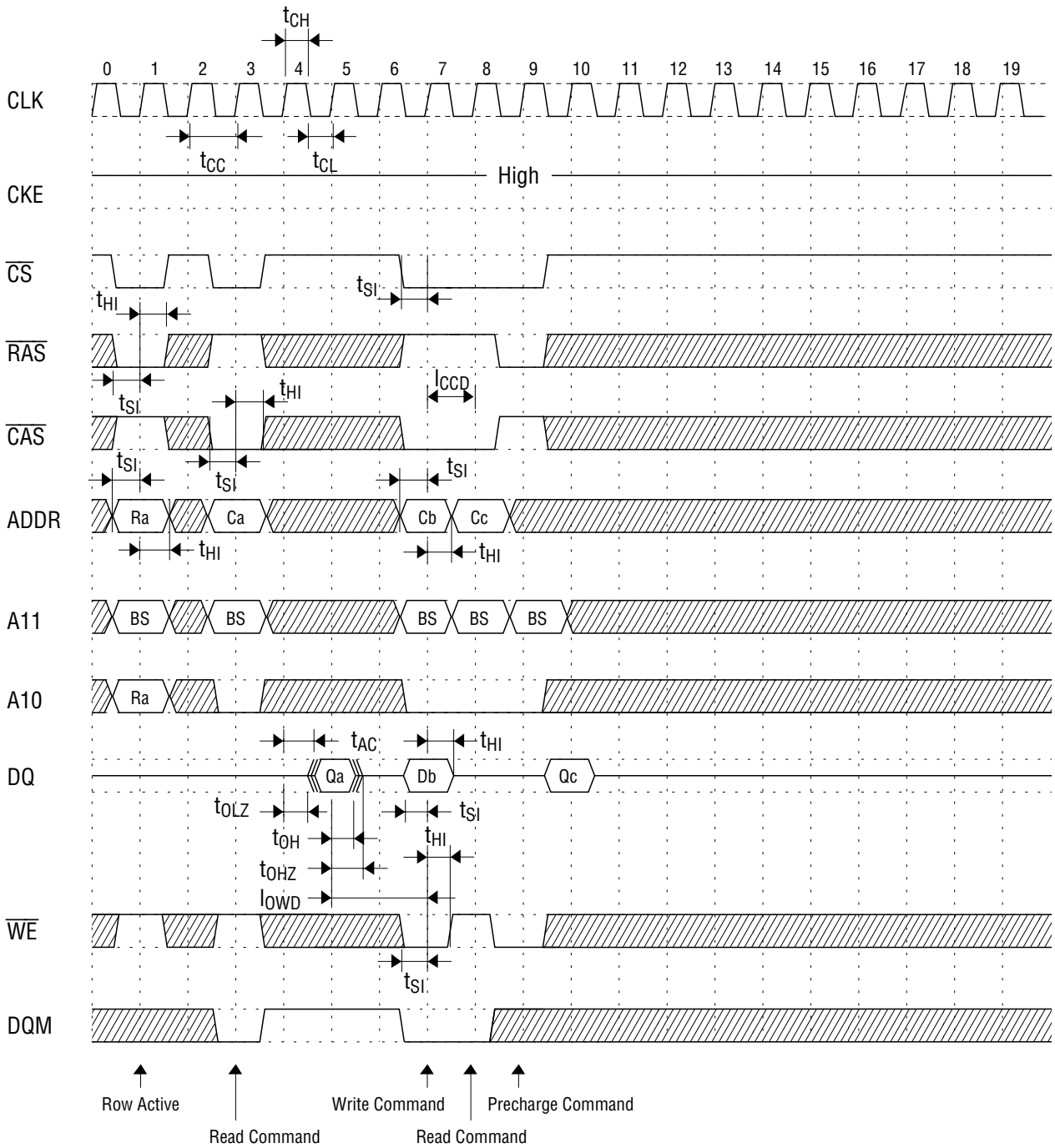

- \*Notes:**
1. When  $\overline{CS}$  is set "High" at a clock transition from "Low" to "High", all inputs except CKE and DQM are invalid.
  2. When issuing an active, read or write command, the bank is selected by A11.

A11	Active, read or write
0	Bank A
1	Bank B

3. The auto precharge function is enabled or disabled by the A10 input when the read or write command is issued.

A10	A11	Operation
0	0	After the end of burst, bank A holds the idle status.
1	0	After the end of burst, bank A is precharged automatically.
0	1	After the end of burst, bank B holds the idle status.
1	1	After the end of burst, bank B is precharged automatically.

4. When issuing a precharge command, the bank to be precharged is selected by the A10 and A11 inputs.

A10	A11	Operation
0	0	Bank A is precharged.
0	1	Bank B is precharged.
1	X	Both banks A and B are precharged.

5. The input data and the write command are latched by the same clock (Write latency = 0).
6. The output is forced to high impedance by  $(1 \text{ CLK} + t_{0HZ})$  after DQM entry.

**Page Read & Write Cycle (Same Bank) @  $\overline{\text{CAS}}$  Latency = 2, Burst Length = 4**

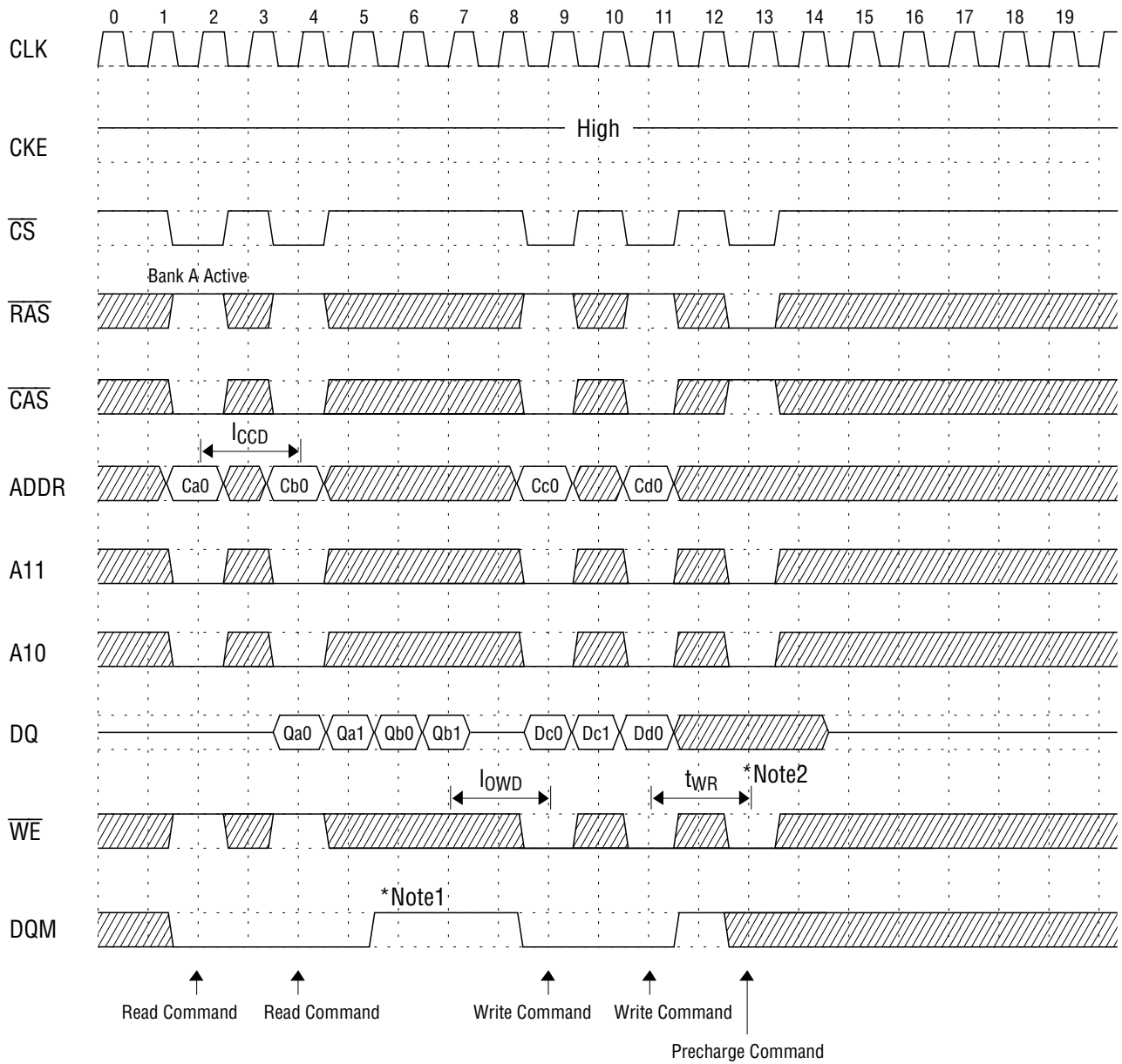

- \*Notes:**
1. To write data before a burst read ends, DQM should be asserted three cycles prior to the write command to avoid bus contention.
  2. To assert row precharge before a burst write ends, wait  $t_{WR}$  after the last write data input. Input data during the precharge input cycle will be masked internally.

Read & Write Cycle with Auto Precharge @ Burst Length = 4

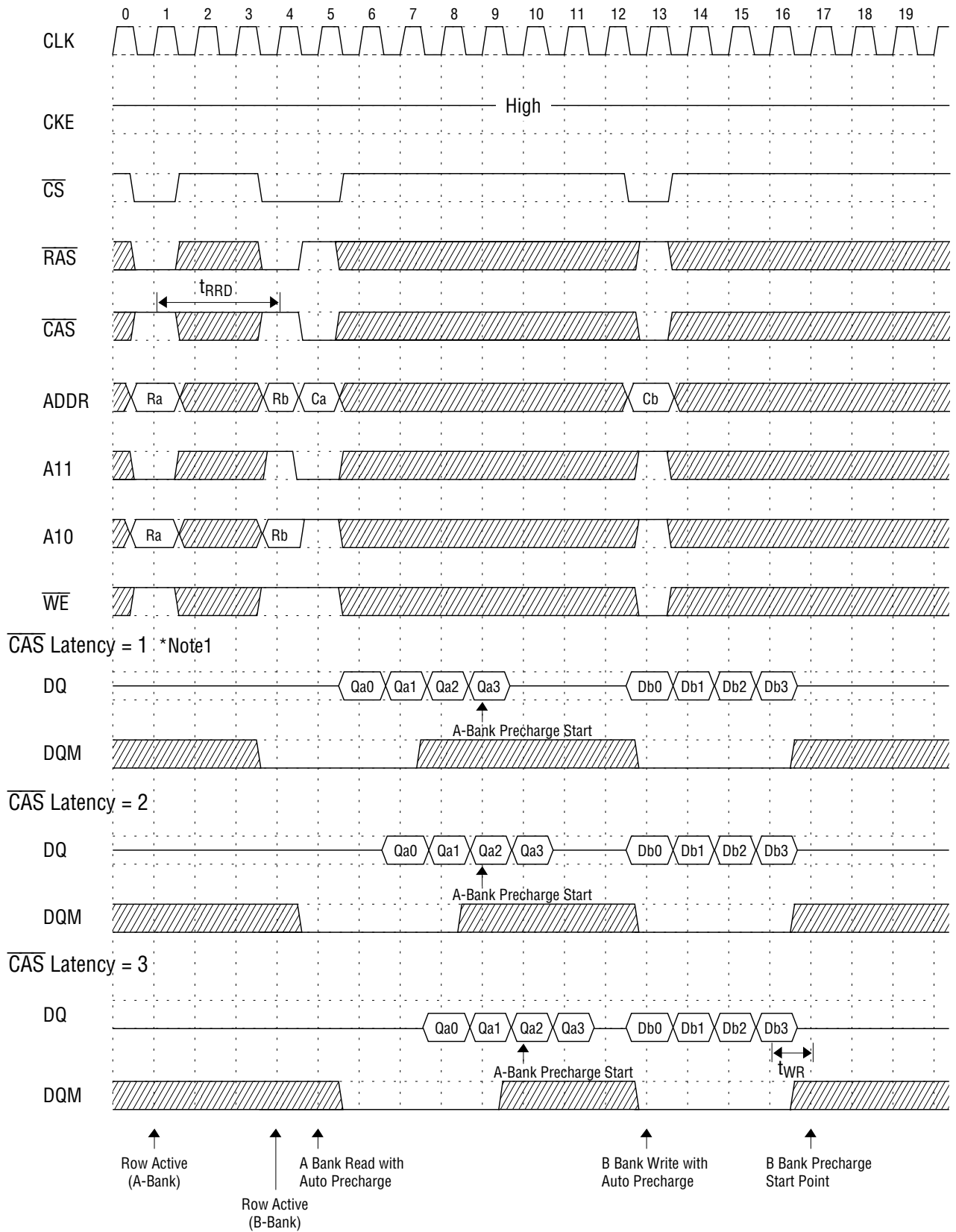

\*Note: 1. Not applicable to H version.

**Bank Interleave Random Row Read Cycle @  $\overline{\text{CAS}}$  Latency = 2, Burst Length = 4**

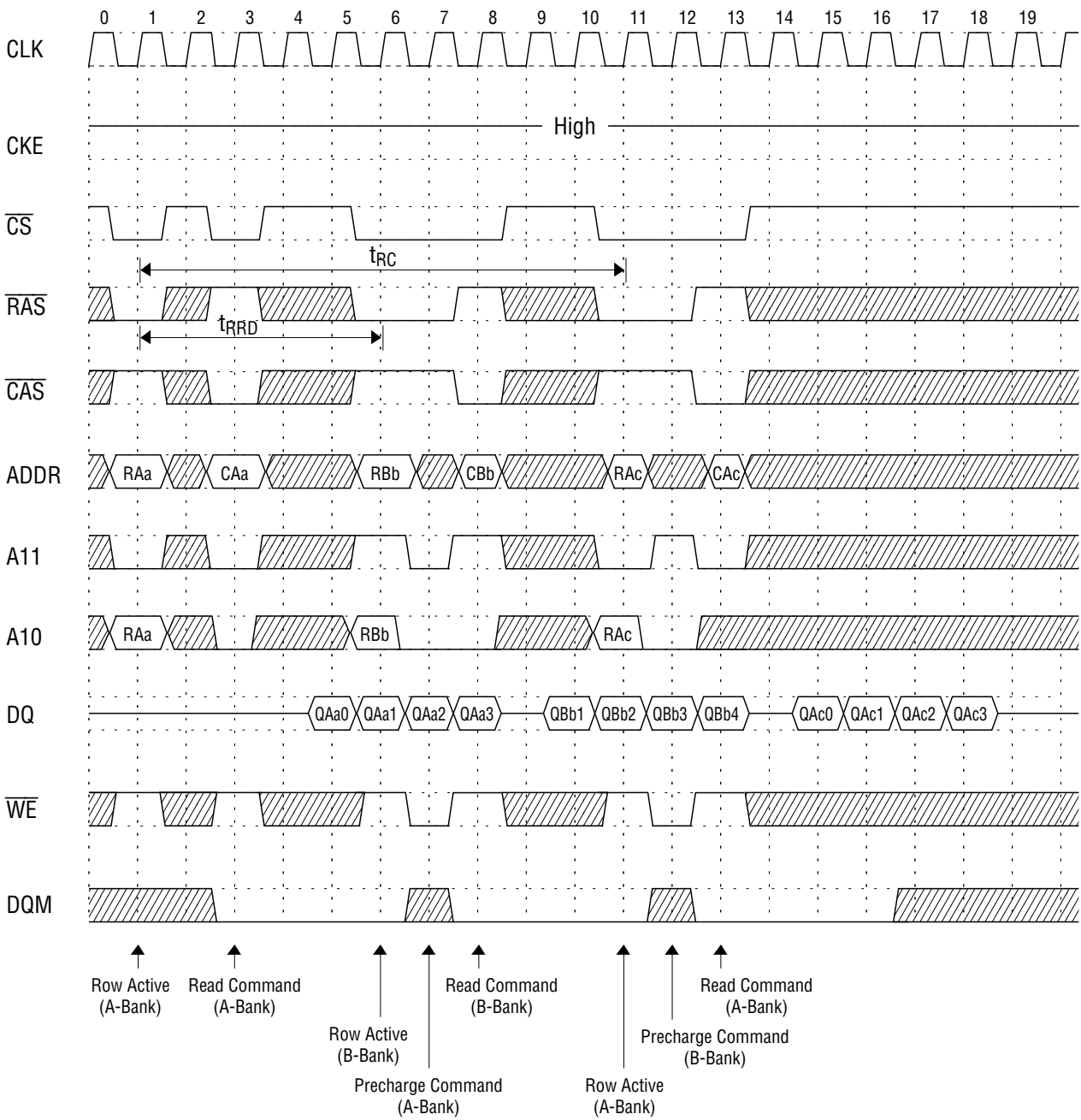

**Bank Interleave Random Row Write Cycle @  $\overline{\text{CAS}}$  Latency = 2, Burst Length = 4**

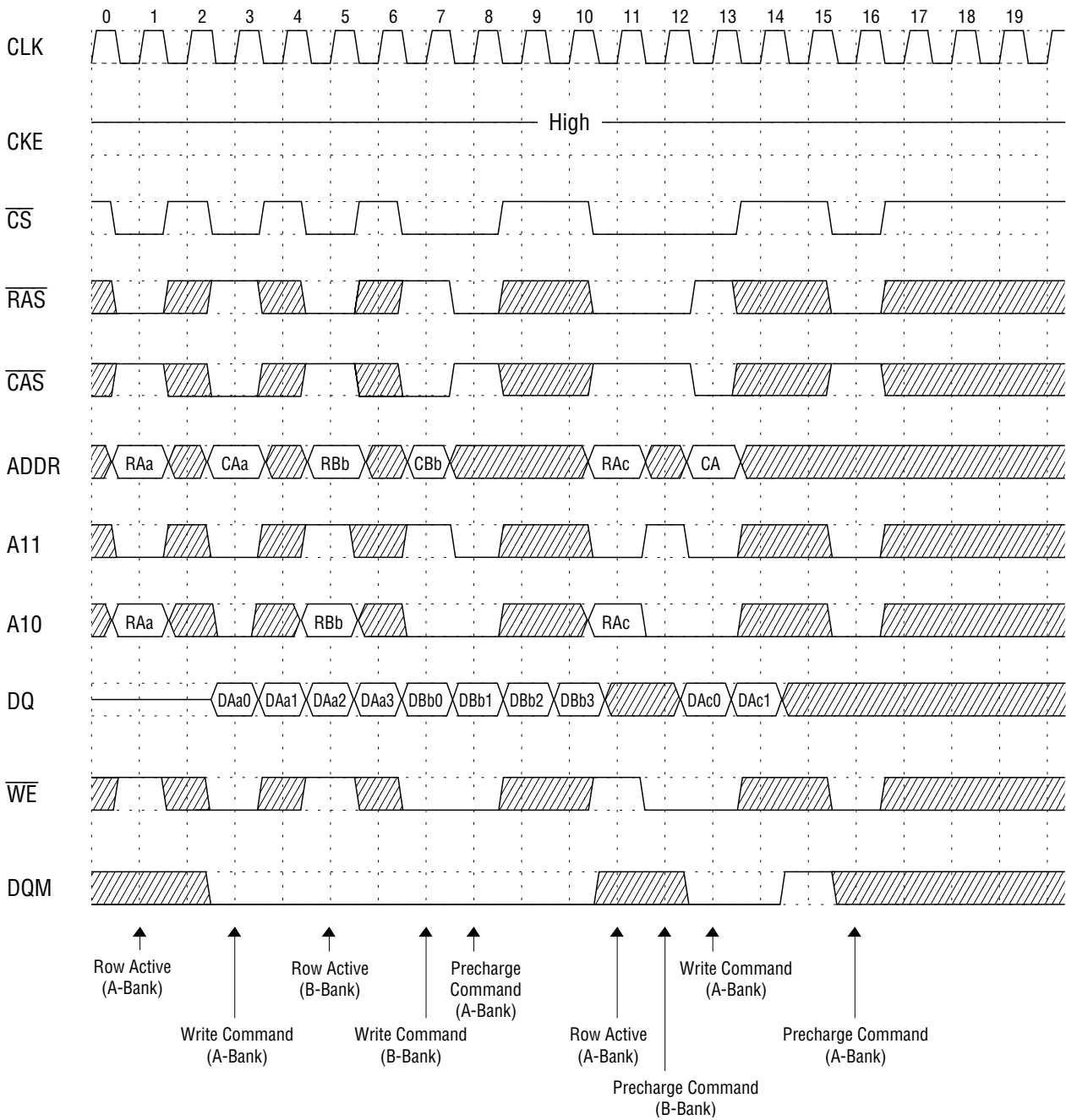



**Bank Interleave Page Read Cycle @  $\overline{\text{CAS}}$  Latency = 2, Burst Length = 4**

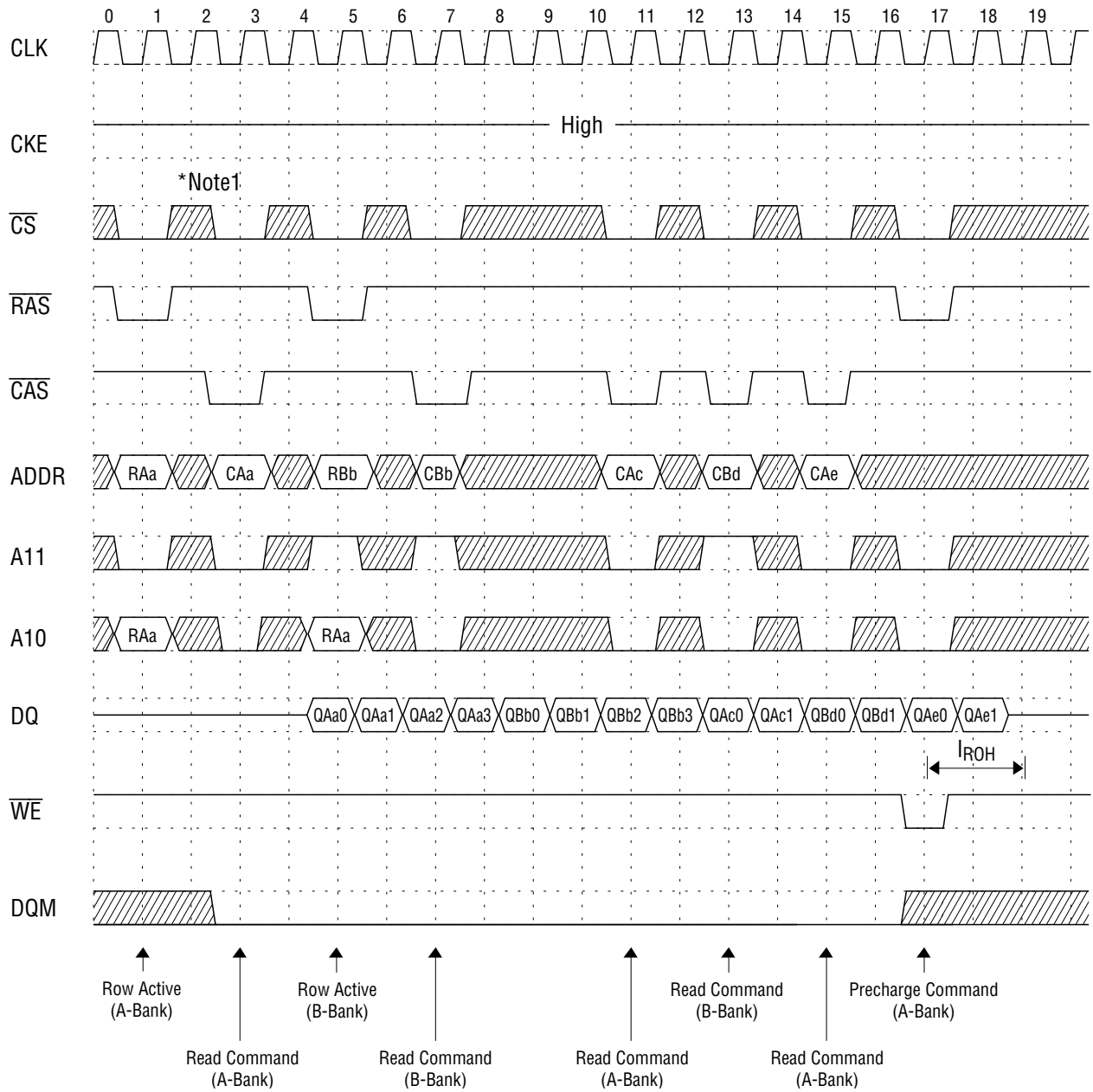

**\*Note:** 1.  $\overline{\text{CS}}$  is ignored when  $\overline{\text{RAS}}$ ,  $\overline{\text{CAS}}$  and  $\overline{\text{WE}}$  are high at the same cycle.

**Bank Interleave Page Write Cycle @  $\overline{\text{CAS}}$  Latency = 2, Burst Length = 4**

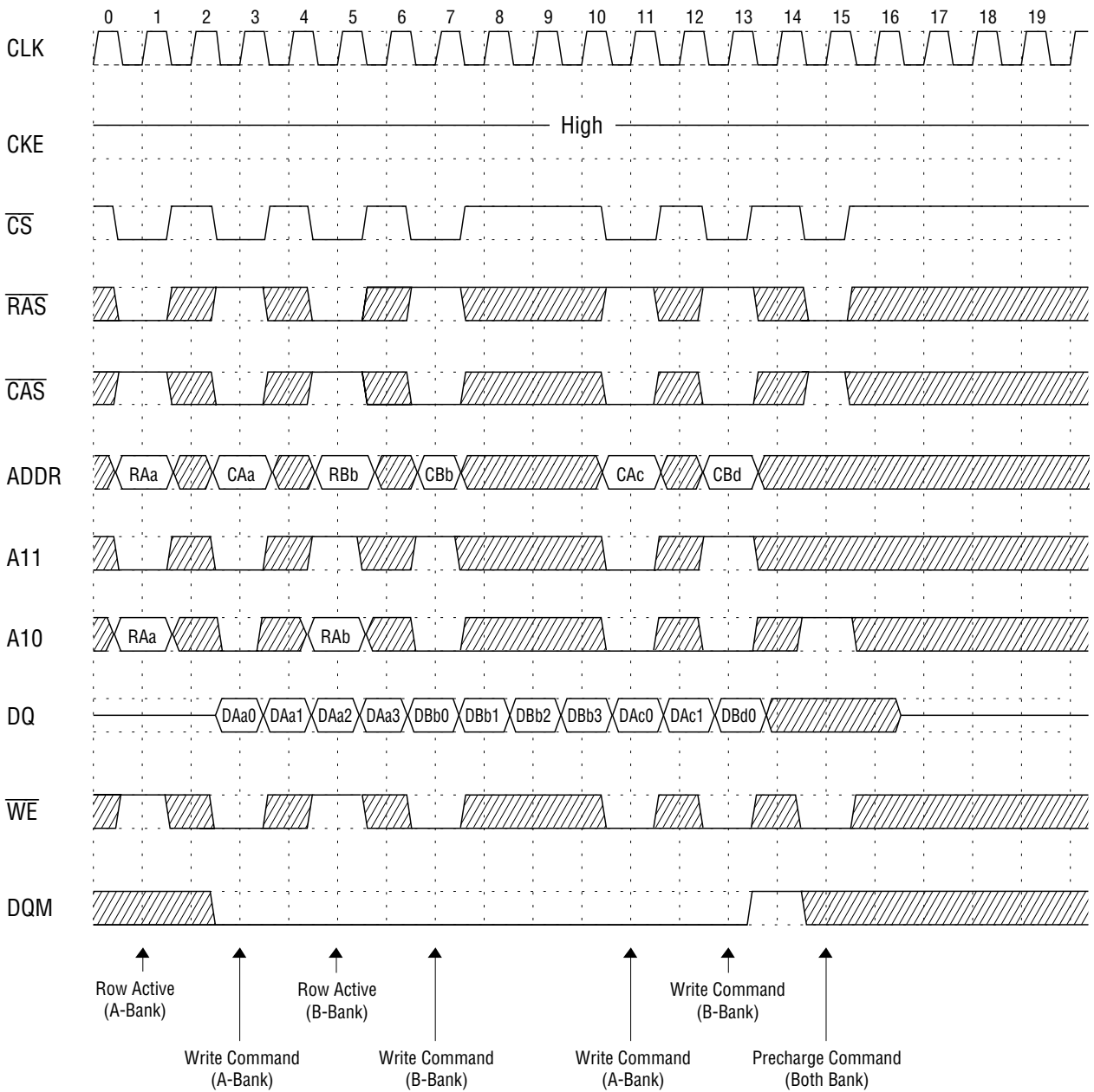

**Bank Interleave Random Row Read/Write Cycle @  $\overline{\text{CAS}}$  Latency = 2, Burst Length = 4**

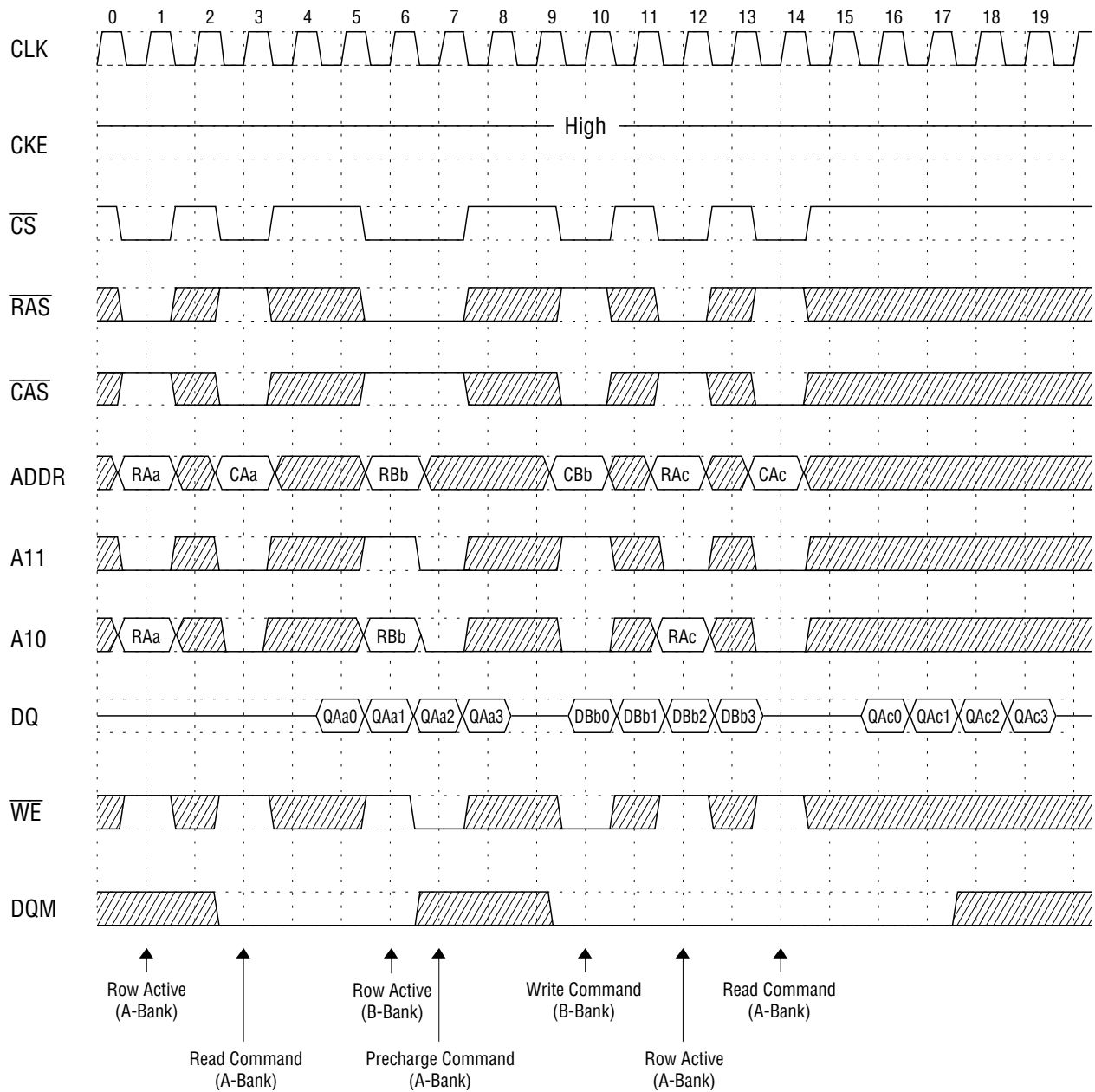

**Bank Interleave Page Read/Write Cycle @  $\overline{\text{CAS}}$  Latency = 2, Burst Length = 4**

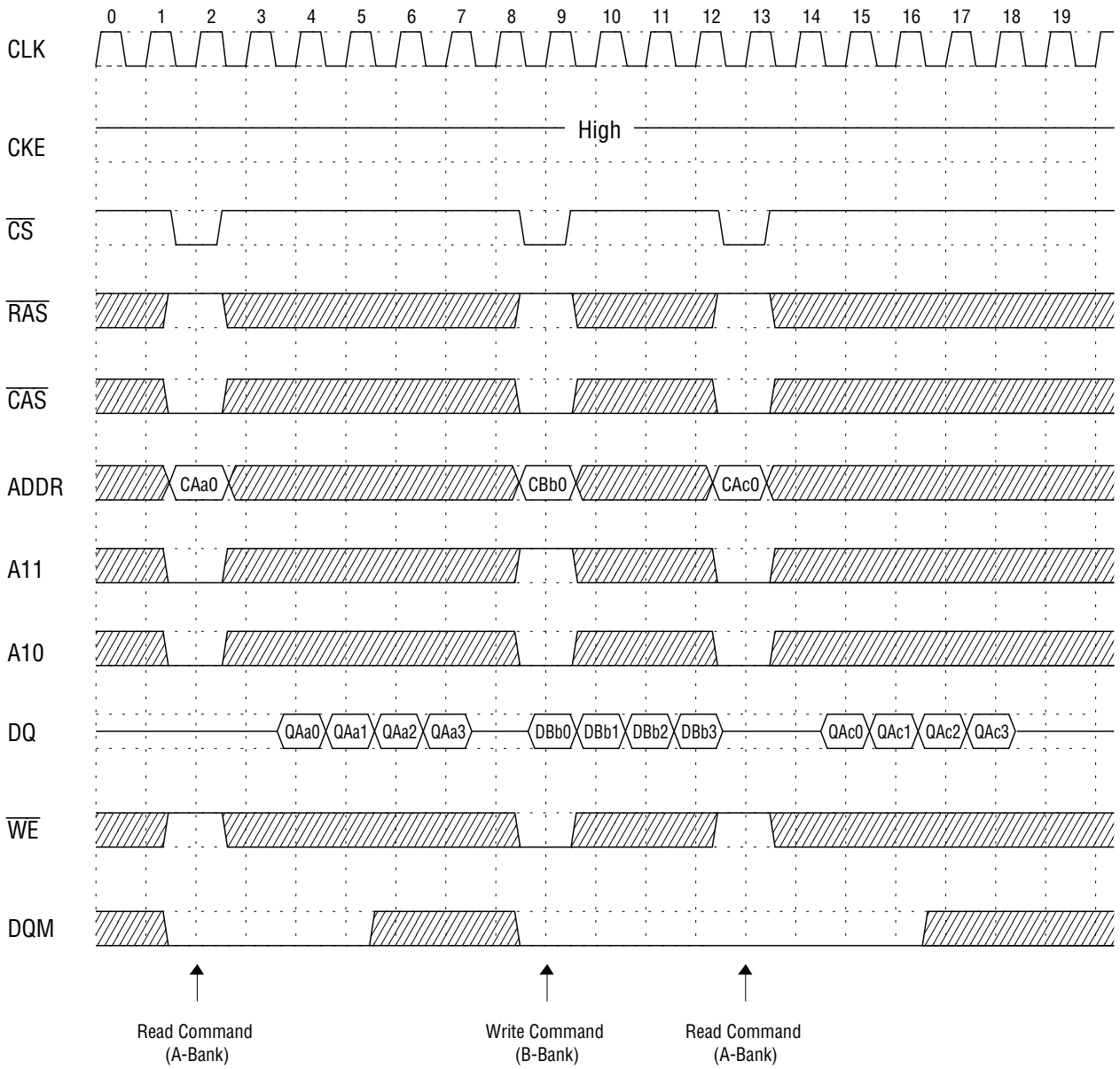

**Clock Suspension & DQM Operation Cycle @  $\overline{\text{CAS}}$  Latency = 2, Burst Length = 4**

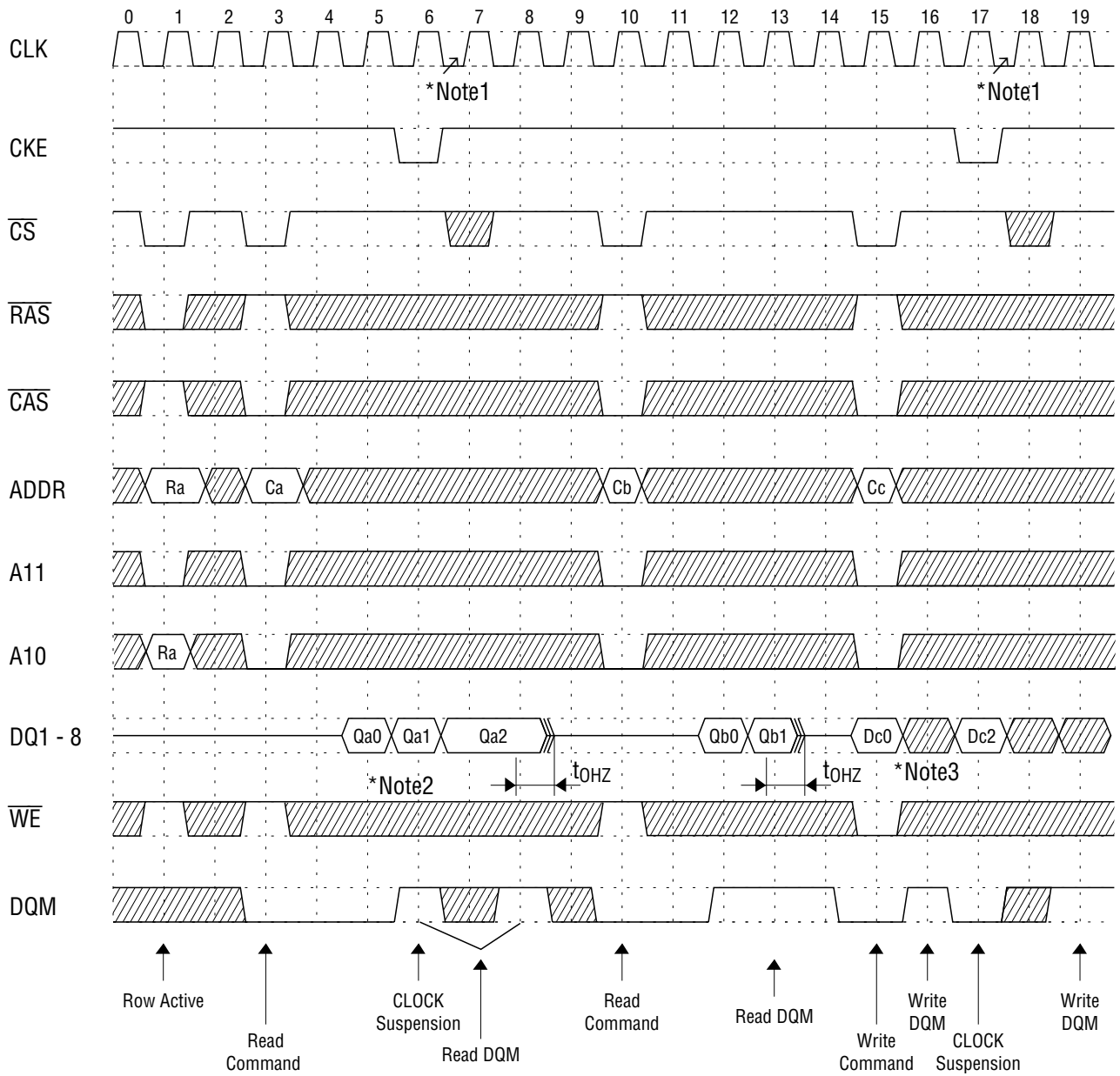

- \*Notes:**
1. When Clock Suspension is asserted, the next clock cycle is ignored.
  2. When DQM is asserted, the read data after two clock cycles is masked.
  3. When DQM is asserted, the write data in the same clock cycle is masked.

**Read to Write Cycle (Same Bank) @  $\overline{\text{CAS}}$  Latency = 2, Burst Length = 4**

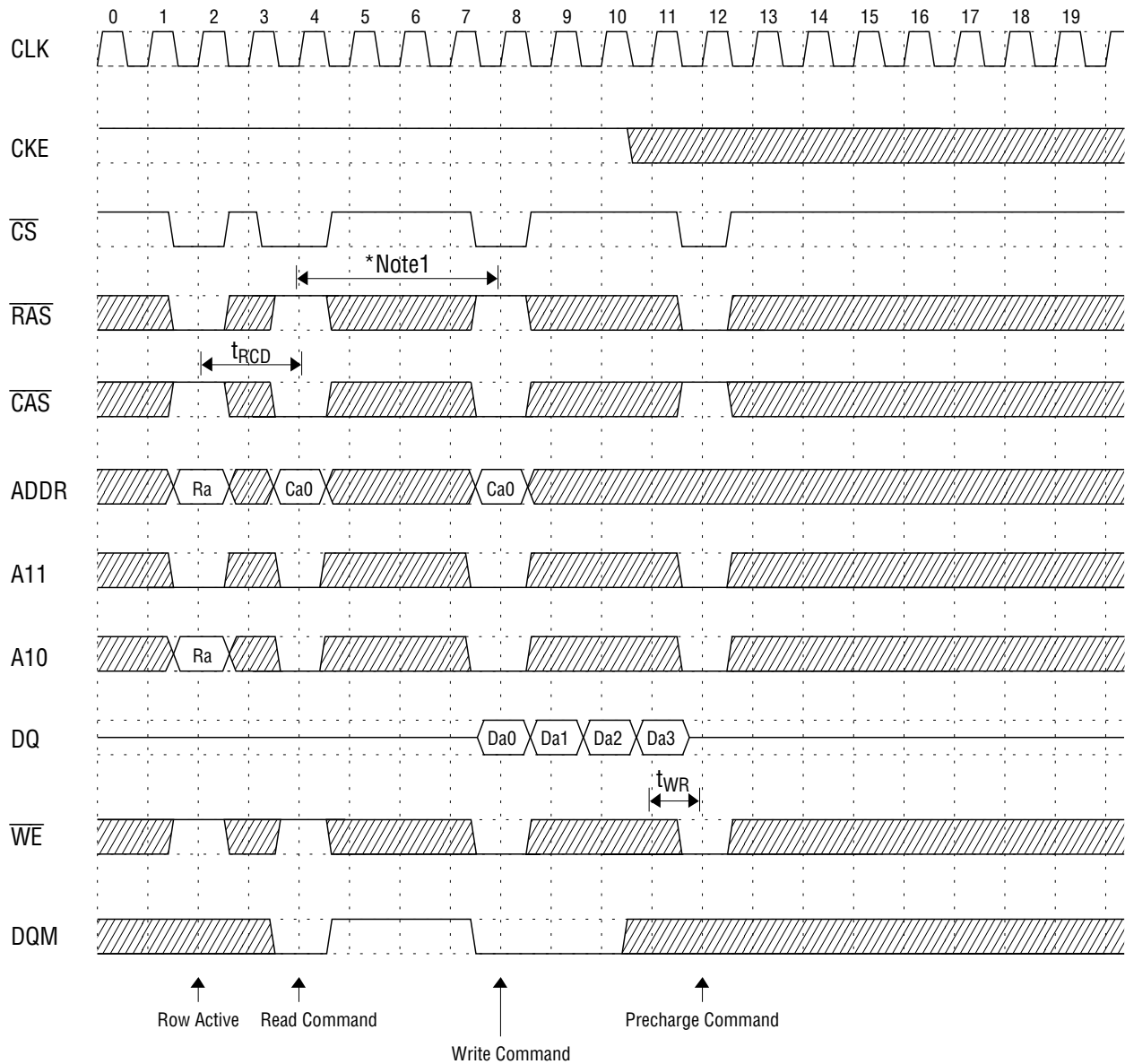

**\*Note:** 1. In case  $\overline{\text{CAS}}$  latency is 3, READ can be interrupted by WRITE. The minimum command interval is [burst length + 1] cycles. DQM must be high at least 3 clocks prior to the write command.

**Read Interruption by Precharge Command @ Burst Length = 8**

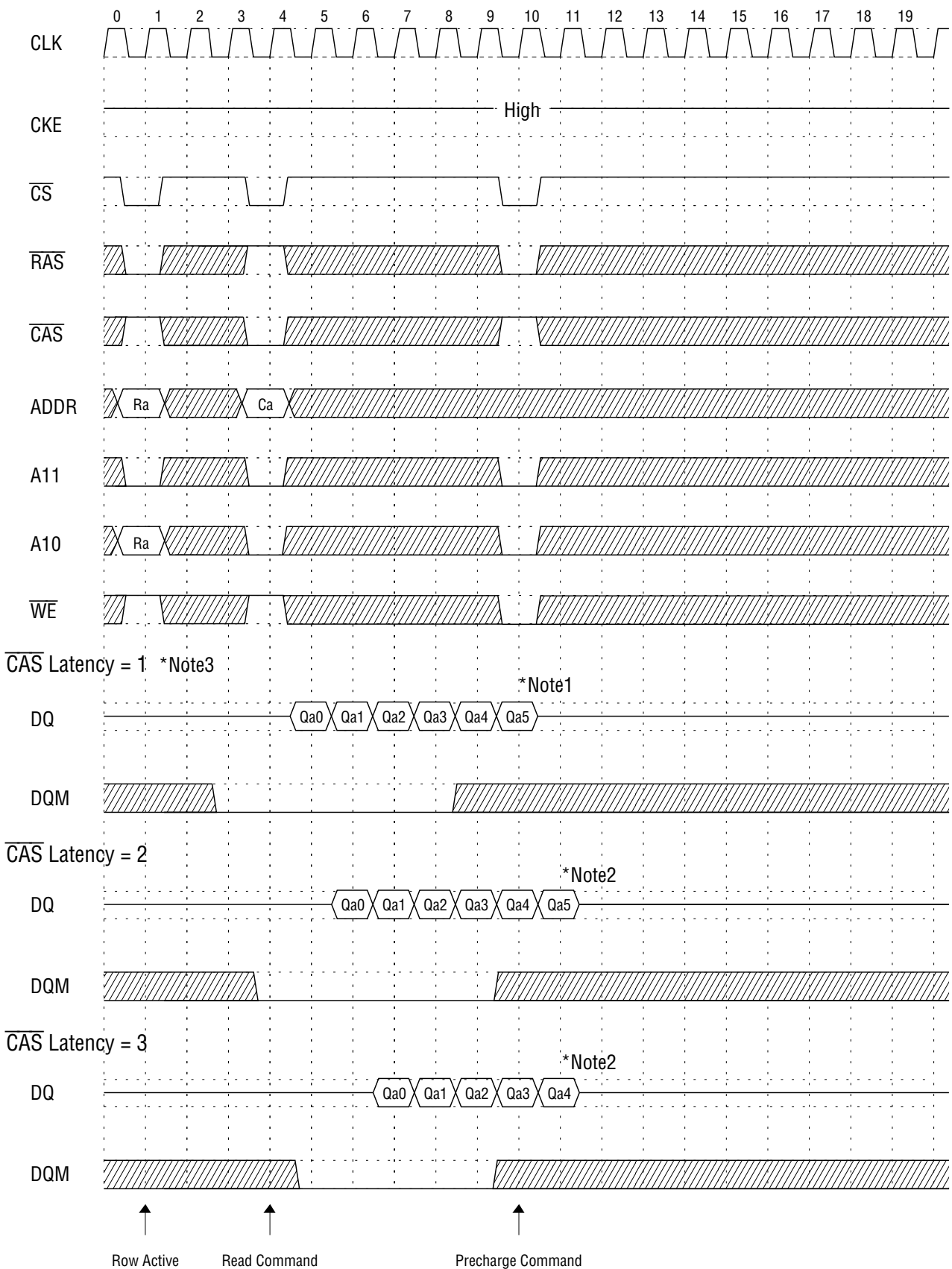

- \*Notes:**
1. When the  $\overline{\text{CAS}}$  latency = 1, and if row precharge is asserted before a burst read ends, then the read data will not output after the next clock cycle of the precharge command.
  2. When the CAS latency = 2 or 3, and if row precharge is asserted before burst read ends, then the read data will not output after the second clock cycle of the precharge command.
  3. Not applicable to H version.

**Power Down Mode @  $\overline{\text{CAS}}$  Latency = 2, Burst Length = 4**

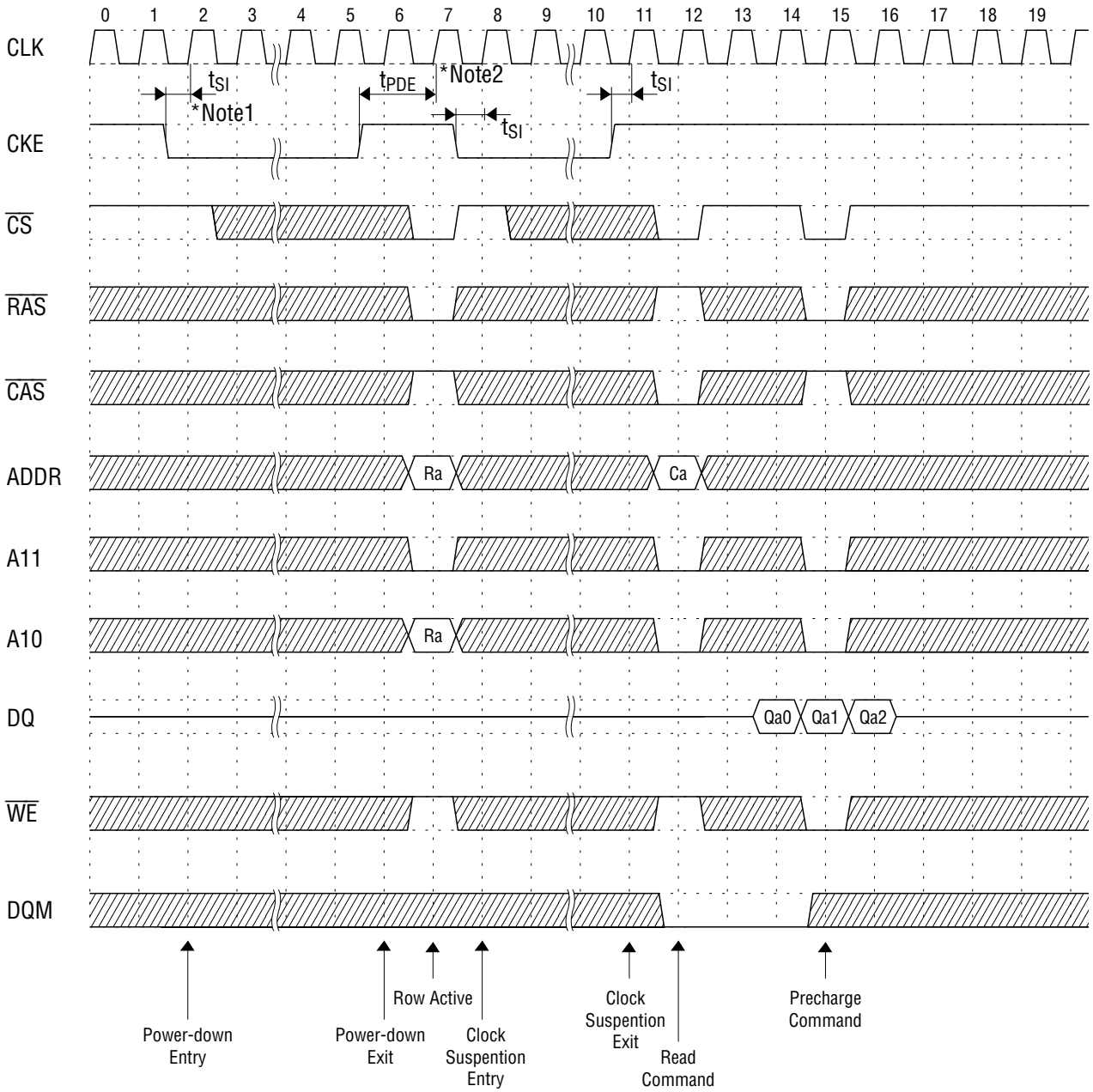

- \*Notes:**
1. When both banks are in precharge state, and if CKE is set low, then the MSM56V16800D/DH enters power-down mode and maintains the mode while CKE is low.
  2. To release the circuit from power-down mode, CKE has to be set high for longer than  $t_{PDE}$  ( $t_{SI} + 1 \text{ CLK}$ ).



Self Refresh Cycle

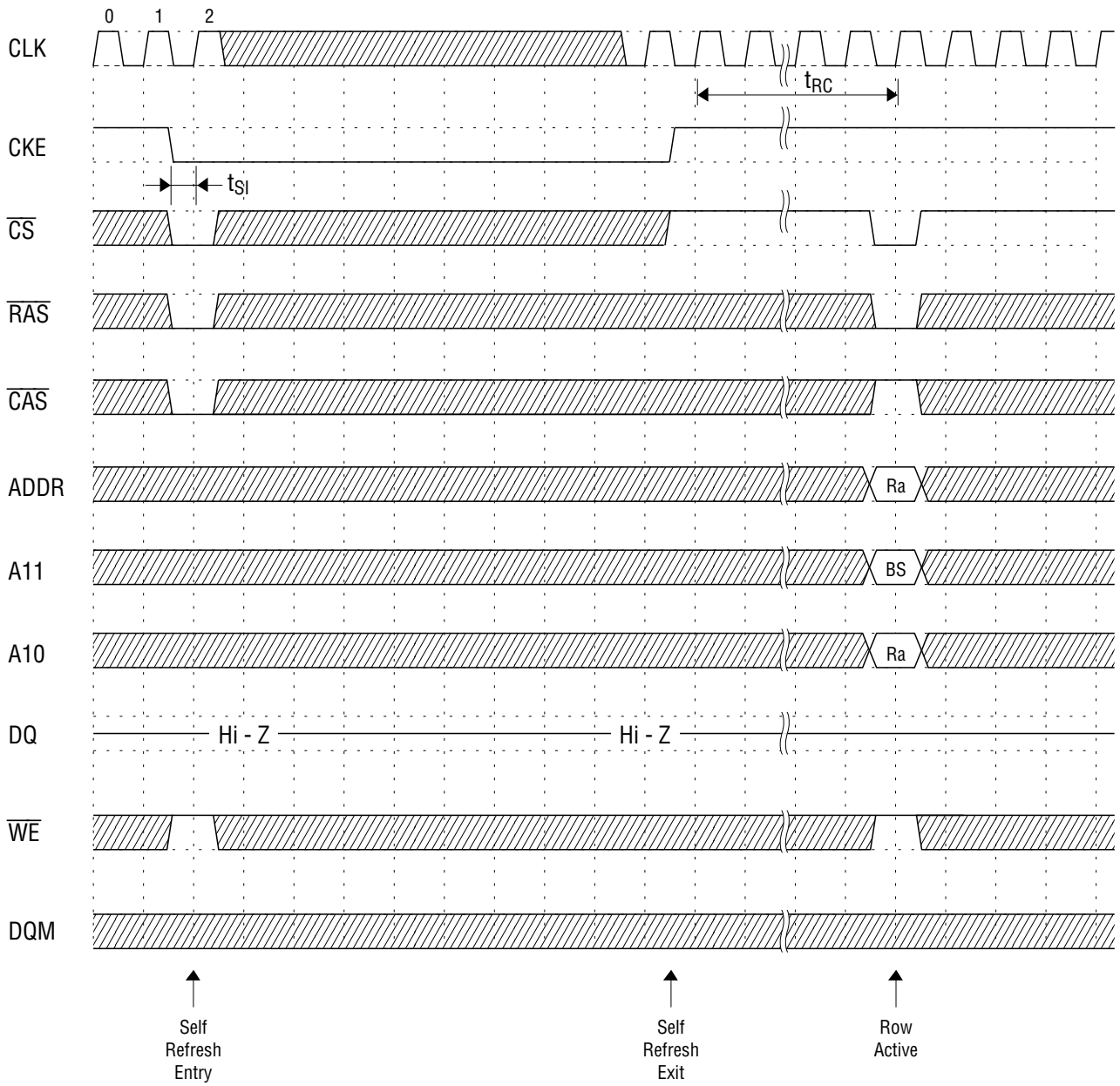

**Mode Register Set Cycle**

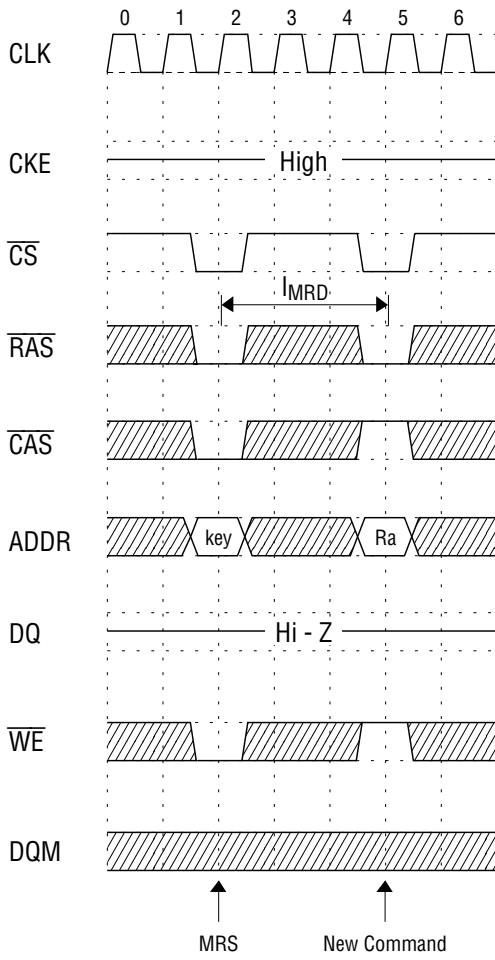

**Auto Refresh Cycle**

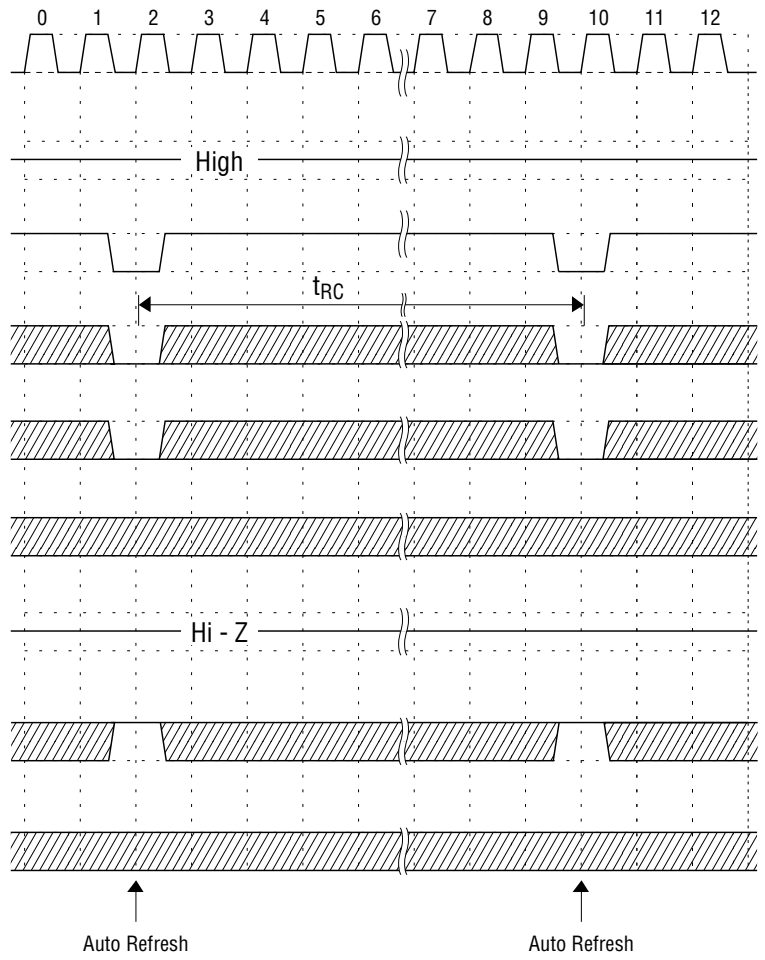

**FUNCTION TRUTH TABLE (Table 1) (1/2)**

Current State <sup>1</sup>	$\overline{CS}$	RAS	$\overline{CAS}$	$\overline{WE}$	BA	ADDR	Action
Idle	H	X	X	X	X	X	NOP
	L	H	H	H	X	X	NOP
	L	H	H	L	BA	X	ILLEGAL <sup>2</sup>
	L	H	L	X	BA	CA	ILLEGAL <sup>2</sup>
	L	L	H	H	BA	RA	Row Active
	L	L	H	L	BA	A10	NOP <sup>4</sup>
	L	L	L	H	X	X	Auto-Refresh or Self-Refresh <sup>5</sup>
	L	L	L	L	L	OP Code	Mode Register Write
Row Active	H	X	X	X	X	X	NOP
	L	H	H	X	X	X	NOP
	L	H	L	H	BA	CA, A10	Read
	L	H	L	L	BA	CA, A10	Write
	L	L	H	H	BA	RA	ILLEGAL <sup>2</sup>
	L	L	H	L	BA	A10	Precharge
	L	L	L	X	X	X	ILLEGAL
Read	H	X	X	X	X	X	NOP (Continue Row Active after Burst ends)
	L	H	H	H	X	X	NOP (Continue Row Active after Burst ends)
	L	H	H	L	BA	X	Reserved
	L	H	L	H	BA	CA, A10	Term Burst, start new Burst Read
	L	H	L	L	BA	CA, A10	Term Burst, start new Burst Write
	L	L	H	H	BA	RA	ILLEGAL <sup>2</sup>
	L	L	H	L	BA	A10	Term Burst, execute Row Precharge
	L	L	L	X	X	X	ILLEGAL
Write	H	X	X	X	X	X	NOP (Continue Row Active after Burst ends)
	L	H	H	H	X	X	NOP (Continue Row Active after Burst ends)
	L	H	H	L	BA	X	ILLEGAL <sup>2</sup>
	L	H	L	H	BA	CA, A10	Term Burst, start new Burst Read
	L	H	L	L	BA	CA, A10	Term Burst, start new Burst Write
	L	L	H	H	BA	RA	ILLEGAL <sup>2</sup>
	L	L	H	L	BA	A10	Term Burst, execute Row Precharge
	L	L	L	X	X	X	ILLEGAL
Read with Auto Precharge	H	X	X	X	X	X	NOP (Continue Burst to End and enter Row Precharge)
	L	H	H	H	X	X	NOP (Continue Burst to End and enter Row Precharge)
	L	H	H	L	BA	X	ILLEGAL <sup>2</sup>
	L	H	L	H	BA	CA, A10	ILLEGAL <sup>2</sup>
	L	H	L	L	X	X	ILLEGAL
	L	L	H	X	BA	RA, A10	ILLEGAL <sup>2</sup>
	L	L	L	X	X	X	ILLEGAL
Write with Auto Precharge	H	X	X	X	X	X	NOP (Continue Burst to End and enter Row Precharge)
	L	H	H	H	X	X	NOP (Continue Burst to End and enter Row Precharge)
	L	H	H	L	BA	X	ILLEGAL <sup>2</sup>
	L	H	L	H	BA	CA, A10	ILLEGAL <sup>2</sup>
	L	H	L	L	X	X	ILLEGAL
	L	L	H	X	BA	RA, A10	ILLEGAL <sup>2</sup>
	L	L	L	X	X	X	ILLEGAL

## FUNCTION TRUTH TABLE (Table 1) (2/2)

Current State <sup>1</sup>	CS	RAS	CAS	WE	BA	ADDR	Action
Precharge	H	X	X	X	X	X	NOP --> Idle after t <sub>RP</sub>
	L	H	H	H	X	X	NOP --> Idle after t <sub>RP</sub>
	L	H	H	L	BA	X	ILLEGAL <sup>2</sup>
	L	H	L	X	BA	CA	ILLEGAL <sup>2</sup>
	L	L	H	H	BA	RA	ILLEGAL <sup>2</sup>
	L	L	H	L	BA	A10	NOP <sup>4</sup>
	L	L	L	X	X	X	ILLEGAL
Write Recovery	H	X	X	X	X	X	NOP
	L	H	H	H	X	X	NOP
	L	H	H	L	BA	X	ILLEGAL <sup>2</sup>
	L	H	L	X	BA	CA	ILLEGAL <sup>2</sup>
	L	L	H	H	BA	RA	ILLEGAL <sup>2</sup>
	L	L	H	L	BA	A10	ILLEGAL <sup>2</sup>
	L	L	L	X	X	X	ILLEGAL
Row Active	H	X	X	X	X	X	NOP --> Row Active after t <sub>RCD</sub>
	L	H	H	H	X	X	NOP --> Row Active after t <sub>RCD</sub>
	L	H	H	L	BA	X	ILLEGAL <sup>2</sup>
	L	H	L	X	BA	CA	ILLEGAL <sup>2</sup>
	L	L	H	H	BA	RA	ILLEGAL <sup>2</sup>
	L	L	H	L	BA	A10	ILLEGAL <sup>2</sup>
	L	L	L	X	X	X	ILLEGAL
Refresh	H	X	X	X	X	X	NOP --> Idle after t <sub>RC</sub>
	L	H	H	X	X	X	NOP --> Idle after t <sub>RC</sub>
	L	H	L	X	X	X	ILLEGAL
	L	L	H	X	X	X	ILLEGAL
	L	L	L	X	X	X	ILLEGAL
Mode Register Access	H	X	X	X	X	X	NOP
	L	H	H	H	X	X	NOP
	L	H	H	L	X	X	ILLEGAL
	L	H	L	X	X	X	ILLEGAL
	L	L	X	X	X	X	ILLEGAL

## ABBREVIATIONS

RA = Row Address

BA = Bank Address

NOP = No Operation command

CA = Column Address

AP = Auto Precharge

- Notes:
1. All inputs are enabled when CKE is set high for at least 1 cycle prior to the inputs.
  2. Illegal to bank in specified state, but may be legal in some cases depending on the state of bank selection.
  3. Satisfy the timing of t<sub>CCD</sub> and t<sub>WR</sub> to prevent bus contention.
  4. NOP to bank precharging or in idle state. Precharges activated bank by BA or A10.
  5. Illegal if any bank is not idle.

## FUNCTION TRUTH TABLE for CKE (Table 2)

Current State (n)	CKEn-1	CKEn	$\overline{CS}$	RAS	CAS	$\overline{WE}$	ADDR	Action
Self Refresh	H	X	X	X	X	X	X	INVALID
	L	H	H	X	X	X	X	Exit Self Refresh --> ABI
	L	H	L	H	H	H	X	Exit Self Refresh --> ABI
	L	H	L	H	H	L	X	ILLEGAL
	L	H	L	H	L	X	X	ILLEGAL
	L	H	L	L	X	X	X	ILLEGAL
	L	L	X	X	X	X	X	NOP (Maintain Self Refresh)
Power Down	H	X	X	X	X	X	X	INVALID
	L	H	H	X	X	X	X	Exit Power Down --> ABI
	L	H	L	H	H	H	X	Exit Power Down --> ABI
	L	H	L	H	H	L	X	ILLEGAL
	L	H	L	H	L	X	X	ILLEGAL
	L	H	L	L	X	X	X	ILLEGAL <sup>6</sup>
	L	L	X	X	X	X	X	NOP (Continue power down mode)
All Banks Idle <sup>6</sup> (ABI)	H	H	X	X	X	X	X	Refer to Table 1
	H	L	H	X	X	X	X	Enter Power Down
	H	L	L	H	H	H	X	Enter Power Down
	H	L	L	H	H	L	X	ILLEGAL
	H	L	L	H	L	X	X	ILLEGAL
	H	L	L	L	H	L	X	ILLEGAL
	H	L	L	L	L	H	X	Enter Self Refresh
	H	L	L	L	L	L	X	ILLEGAL
	L	L	X	X	X	X	X	NOP
Any State Other than Listed Above	H	H	X	X	X	X	X	Refer to Operations in Table 1
	H	L	X	X	X	X	X	Begin Clock Suspend Next Cycle
	L	H	X	X	X	X	X	Enable Clock of Next Cycle
	L	L	X	X	X	X	X	Continue Clock Suspension

Note: 6. Power-down and self refresh can be entered only when all the banks are in an idle state.

PACKAGE DIMENSIONS

(Unit : mm)

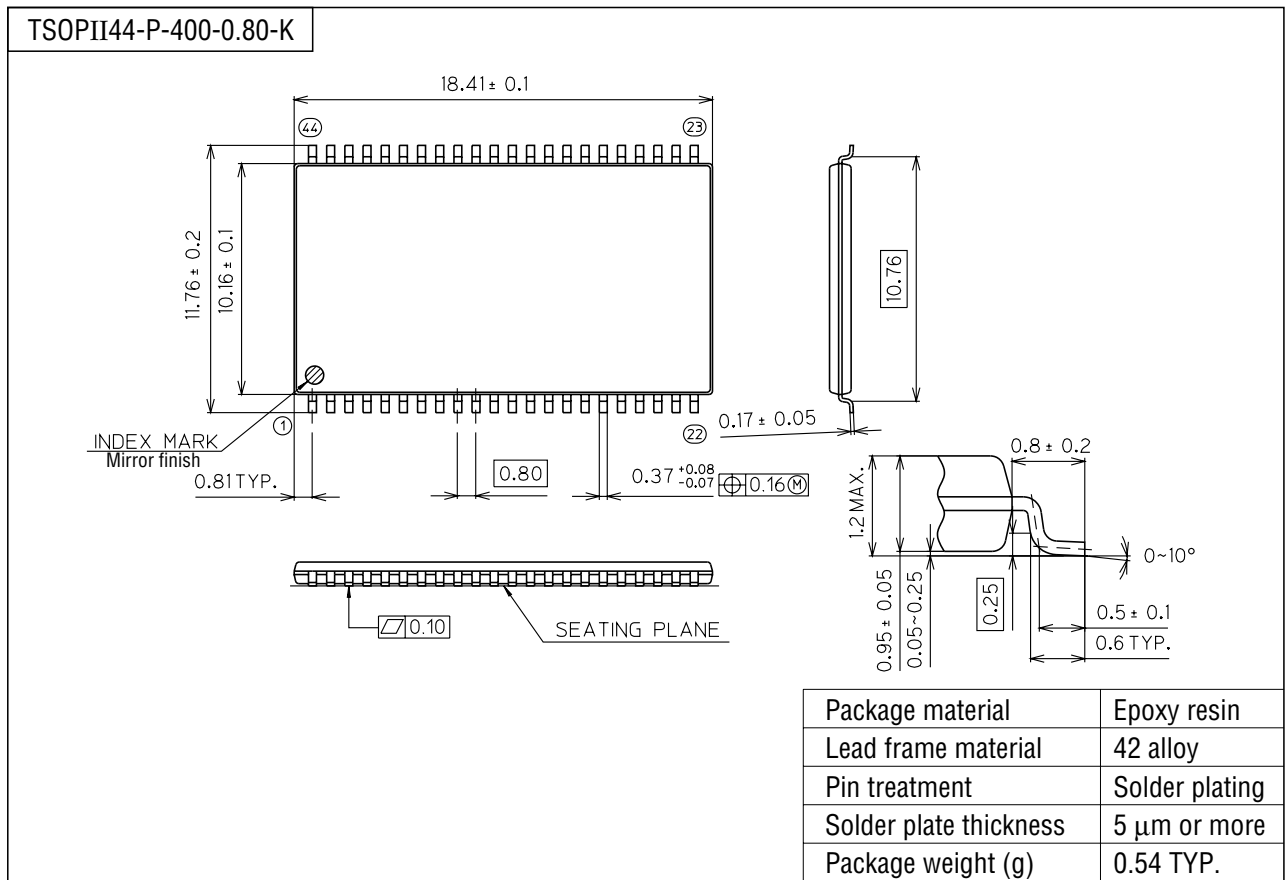

Notes for Mounting the Surface Mount Type Package

The SOP, QFP, TSOP, SOJ, QFJ (PLCC), SHP and BGA are surface mount type packages, which are very susceptible to heat in reflow mounting and humidity absorbed in storage. Therefore, before you perform reflow mounting, contact Oki's responsible sales person for the product name, package name, pin number, package code and desired mounting conditions (reflow method, temperature and times).