

7.5A, 5A, 3A, 1.5A LOW DROPOUT FIXED VOLTAGE POSITIVE REGULATORS

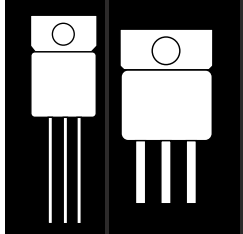

**Three Terminal +5V, +12V, +15V, Low Dropout
 TO-257/TO-258 Fixed Voltage Regulators**

FEATURES

- +5V, +12V, and +15V Output Voltage
- Operates Down to 1V Dropout
- .015% Line Regulation / .01% Load Regulation
- Output Voltage Trimmed to ±1%
- Hermetic TO-257 and TO-258 Isolated Package

DESCRIPTION

These three terminal positive fixed voltage regulators are designed to provide 7.5A, 5A, 3A, and 1.5A with higher efficiency than conventional voltage regulators. The devices are designed to operate to 1 Volt input to output differential and the dropout voltage is specified as a function of load current. All devices are pin compatible with older three terminal regulators. Supplied in the easy-to-use hermetic metal TO-257 and TO-258 JEDEC packages, these devices are ideally suited for Military applications where small size, hermeticity and high reliability are required.

ABSOLUTE MAXIMUM RATINGS

Input Voltage	30 V
Operating Junction Temperature Range	- 55°C to + 150°C
Storage Temperature	- 65°C to + 150°C
Output Current -OM183-5, 12, 15SC	7.5 A
OM184-5, 12, 15SC	5 A
OM185-5, 12, 15ST	3 A
OM186-5, 12, 15ST	1.5 A

3.3

Note: OM183SC and OM184SC products are packaged in the TO-258 Package (7.5A & 5A).
 OM185ST and OM186ST products are packaged in the TO-257 Package (3A & 1.5A).

Part Number Designator

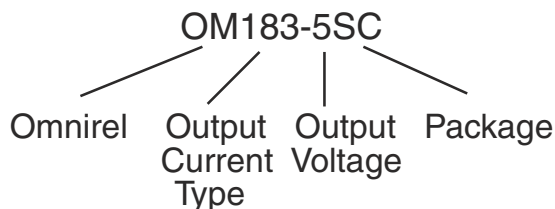

OM183-5SC - OM186-15ST

ELECTRICAL CHARACTERISTICS ($T_C = 25^\circ\text{C}$ unless otherwise noted)

Parameter	Conditions	Min.	Typ.	Max.	Units
Output Voltage					
OM183/4/5/6 - 5 V	$I_{OUT} = 0 \text{ mA}$, $T_j = 25^\circ\text{C}$, $V_{IN} = 8 \text{ V}$	4.95	5.0	5.05	V
	$0 \leq I_{OUT} \leq I_{FULL\ LOAD}$, $6.5 \text{ V} \leq V_{IN} \leq 30 \text{ V}$	4.90	5.0	5.10	V
OM183/4/5/6 - 12 V	$I_{OUT} = 0 \text{ mA}$, $T_j = 25^\circ\text{C}$, $V_{IN} = 15 \text{ V}$	11.88	12.0	12.12	V
	$0 \leq I_{OUT} \leq I_{FULL\ LOAD}$, $13.5 \text{ V} \leq V_{IN} \leq 30 \text{ V}$	11.76	12.0	12.24	V
OM183/4/5/6 - 15 V	$I_{OUT} = 0 \text{ mA}$, $T_j = 25^\circ\text{C}$, $V_{IN} = 20 \text{ V}$	14.85	15.0	15.15	V
	$0 \leq I_{OUT} \leq I_{FULL\ LOAD}$, $17.5 \text{ V} \leq V_{IN} \leq 30 \text{ V}$	14.70	15.0	15.30	V
Line Regulation					
OM183/4/5/6 - 5 V	$I_{OUT} = 0 \text{ mA}$, $T_j = 25^\circ\text{C}$, $6.5 \text{ V} \leq V_{IN} \leq 20 \text{ V}$		0.5	10	mV
	$6.5 \text{ V} \leq V_{IN} \leq 30 \text{ V}$		1.0	10	mV
			2.0	25	mV
OM183/4/5/6 - 12 V	$I_{OUT} = 0 \text{ mA}$, $T_j = 25^\circ\text{C}$, $13.5 \text{ V} \leq V_{IN} \leq 25 \text{ V}$		1.0	25	mV
			2.0	25	mV
	$13.5 \text{ V} \leq V_{IN} \leq 30 \text{ V}$		4.0	60	mV
OM183/4/5/6 - 15 V	$I_{OUT} = 0 \text{ mA}$, $T_j = 25^\circ\text{C}$, $17.5 \text{ V} \leq V_{IN} \leq 25 \text{ V}$		2.0	50	mV
			4.0	50	mV
	$17.5 \text{ V} \leq V_{IN} \leq 30 \text{ V}$		8.0	100	mV
Load Regulation					
OM183/4/5/6 - 5 V	$V_{IN} = 8 \text{ V}$, $0 \leq I_{OUT} \leq I_{FULL\ LOAD}$, $T_j = 25^\circ\text{C}$		5	20	mV
			10	35	mV
OM183/4/5/6 - 12 V	$V_{IN} = 15 \text{ V}$, $0 \leq I_{OUT} \leq I_{FULL\ LOAD}$, $T_j = 25^\circ\text{C}$		12	36	mV
			24	72	mV
OM183/4/5/6 - 15 V	$V_{IN} = 20 \text{ V}$, $0 \leq I_{OUT} \leq I_{FULL\ LOAD}$, $T_j = 25^\circ\text{C}$		20	40	mV
			40	100	mV
Current Limit					
OM183 - 5 V	$V_{IN} = 10 \text{ V}$	7.5	9.5		A
OM183 - 12 V	$V_{IN} = 17 \text{ V}$	7.5	9.5		A
OM183 - 15 V	$V_{IN} = 20 \text{ V}$	7.5	9.5		A
OM184 - 5 V	$V_{IN} = 10 \text{ V}$	5.0	6.5		A
OM184 - 12 V	$V_{IN} = 17 \text{ V}$	5.0	6.5		A
OM184 - 15 V	$V_{IN} = 20 \text{ V}$	5.0	6.5		A
OM185 - 5 V	$V_{IN} = 10 \text{ V}$	3.0	4.0		A
OM185 - 12 V	$V_{IN} = 17 \text{ V}$	3.0	4.0		A
OM185 - 15 V	$V_{IN} = 20 \text{ V}$	3.0	4.0		A
OM186 - 5 V	$V_{IN} = 10 \text{ V}$	1.5	1.8		A
OM186 - 12 V	$V_{IN} = 17 \text{ V}$	1.5	1.8		A
OM186 - 15 V	$V_{IN} = 20 \text{ V}$	1.5	1.8		A
Dropout Voltage					
OM183/4/5/6 - 5 V	$\Delta V_{OUT} = 50 \text{ mV}$, $I_{OUT} = I_{FULL\ LOAD}$		6.3	6.5	V
OM183/4/5/6 - 12 V	$\Delta V_{OUT} = 120 \text{ mV}$, $I_{OUT} = I_{FULL\ LOAD}$		13.3	13.5	V
OM183/4/5/6 - 15 V	$\Delta V_{OUT} = 180 \text{ mV}$, $I_{OUT} = I_{FULL\ LOAD}$		17.3	17.5	V
Quiescent Current	$V_{IN} \leq 30 \text{ V}$		5.0	10.0	mA
Thermal Regulation	$T_A = 25^\circ\text{C}$, 30 ms pulse				
OM183 - 5/12/15 V			0.002	0.01	%/W
OM184 - 5/12/15 V			0.003	0.015	%/W
OM185 - 5/12/15 V			0.004	0.02	%/W
OM186 - 5/12/15 V			0.008	0.04	%/W
Ripple Rejection	$f = 120 \text{ Hz}$, $C_{OUT} = 25 \mu\text{F}$ Tantalum				
	$I_{OUT} = I_{FULL\ LOAD}$				
OM183/4/5/6 - 5 V	$V_{IN} = 8 \text{ V}$		63		dB
OM183/4/5/6 - 12 V	$V_{IN} = 15 \text{ V}$		55		dB
OM183/4/5/6 - 15 V	$V_{IN} = 20 \text{ V}$		60		dB
Temperature Stability			0.5		%
Long Term Stability	$T_A = 125^\circ\text{C}$, 1000 Hrs.		0.03	1.0	%
RMS Output Noise (% of V_{OUT})	$T_A = 25^\circ\text{C}$, $10 \text{ Hz} \leq f \leq 10 \text{ kHz}$		0.003		%
Thermal Resistance	Junction-To-Case				
TO-257AA				3.5	$^\circ\text{C/W}$
TO-258AA				2.75	$^\circ\text{C/W}$

3.3

TYPICAL PERFORMANCE CHARACTERISTICS

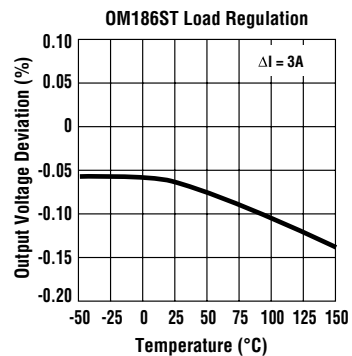
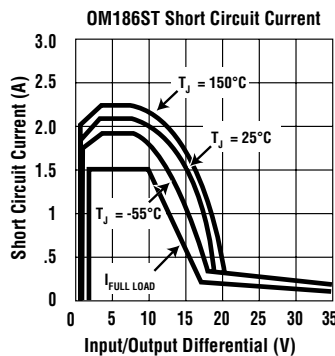
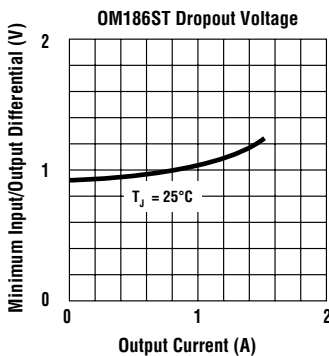
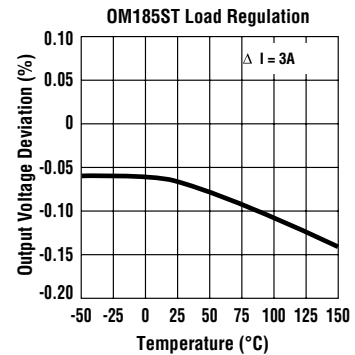
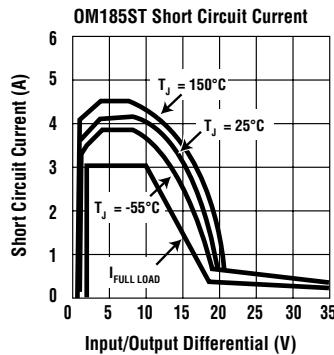
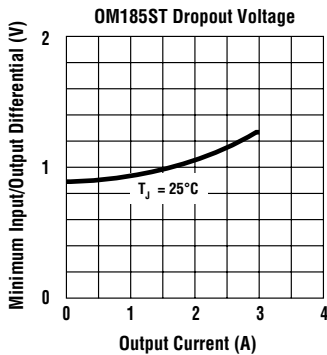
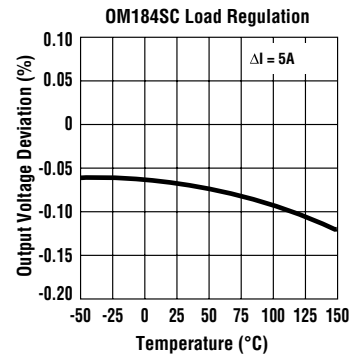
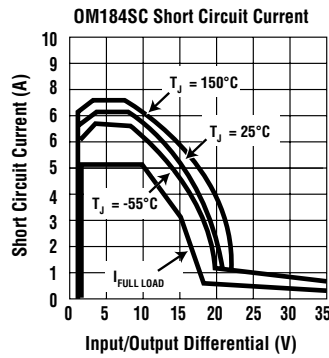
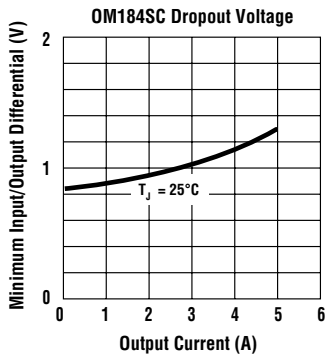
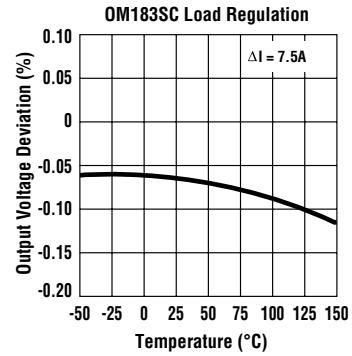
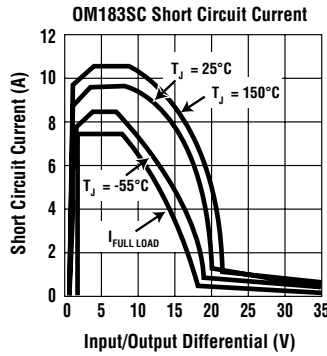
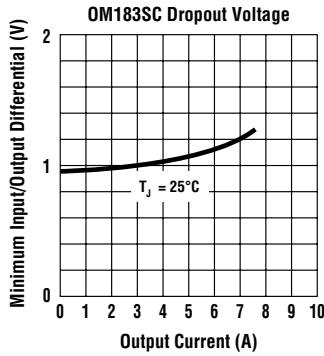

3.3

APPLICATION NOTES

This family of three terminal regulators is easy to use and has all the protection features that are expected in high performance voltage regulators. They are short circuit protected, have safe area protection as well as thermal shutdown to turn off the regulator should the temperature exceed about 165°C.

These regulators offer lower dropout voltage and more precise reference tolerance. Further, the reference stability with temperature is improved over older types of regulators. The only circuit difference between using this family and older regulators is that they require an output capacitor for stability.

Overload Recovery

When power is first turned on, as the input voltage rises, the output follows the input, allowing the regulator to start up into very heavy loads. During the start-up, as the input voltage is rising, the input-to-output voltage differential remains small, allowing the regulator to supply large output currents. With high input voltage, a problem can occur wherein removal of an output short will not allow the output voltage to recover. Older regulators, such as the 7800 series, also exhibited this phenomenon, so it is not unique to the OM183-5.

The problem occurs with a heavy output load when the input voltage is high and the output voltage is low, such as immediately after a removal of a short. The load line for such a load may intersect the output current curve at two points. If this happens, there are two stable output operating points for the regulator. With this double intersection, the power supply may need to be cycled down to zero and brought up again to make the output recover.

Thermal Conditions

This series of regulators has internal power and thermal limiting circuitry designed to protect the device under overload conditions. For continuous normal load conditions however, maximum junction temperature ratings must not be exceeded. It is important to give careful consideration to all sources of thermal resistance from junction to ambient. This includes junction to case, case to heat sink interface, and heat sink resistance itself. New thermal resistance specifications have been developed to more accurately reflect device temperature and ensure safe operating temperatures. The data section for these new regulators provides a separate thermal resistance and maximum junction temperature for both the *Control Section* and the *Power Transistor*. Previous regulators, with a single junction to case thermal resistance specification, used an average of the two values provided here and therefore could allow excessive junction temperature under certain conditions of ambient temperature and heat sink resistance. To avoid this possibility, calculations should be made for both sections to ensure that both thermal limits are met.

Junction-to-case thermal resistance is specified from the IC junction to the bottom of the case directly below the die. This is the lowest resistance path for heat flow. Proper mounting is required to ensure the best possible thermal flow from this area of the package to the heat sink. Thermal compound at the case-to-heat-sink interface is strongly recommended. If the case of the device must be electrically isolated, a thermally conductive spacer can be used, as long as its added contribution to thermal resistance is considered. Note that the case of all devices in this series is electrically connected to the output.

MECHANICAL SPECIFICATIONS P/N OM183SC and OM184SC JEDEC TO-258AA

MECHANICAL OUTLINE

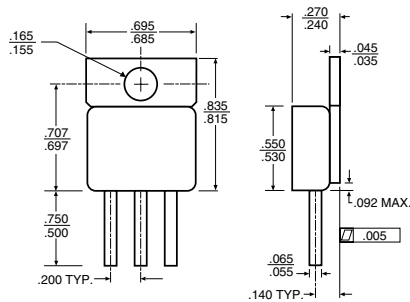

PIN CONNECTION

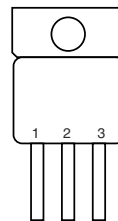

Pin 1 - Ground
Pin 2 - V_{OUT}
Pin 3 - V_{IN}

P/N OM185ST and OM186ST JEDEC TO-257AA

MECHANICAL OUTLINE

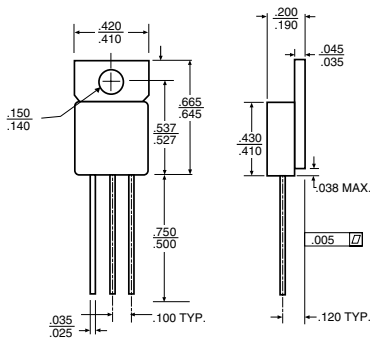

PIN CONNECTION

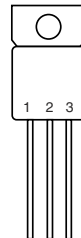

Pin 1 - Ground
Pin 2 - V_{OUT}
Pin 3 - V_{IN}

3.3