

OM5221SA/RA/DA OM5223SA/RA/DA OM5225SA/RA/DA  
 OM5222SA/RA/DA OM5224SA/RA/DA OM5226SA/RA/DA

# HERMETIC JEDEC TO-254AA HIGH EFFICIENCY, CENTER-TAP RECTIFIER

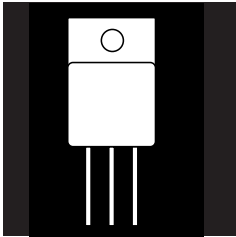

**24 Amp, 50 To 600 Volts, 35 To 50 nsec**

## FEATURES

- Very Low Forward Voltage
- Very Fast Switching Speed
- Hermetic Metal Package, JEDEC TO-254AA
- High Surge
- Small Size
- Isolated Package
- Ceramic Feedthroughs Available
- Available Screened To MIL-S-19500, TX, TXV And S Levels

## DESCRIPTION

This series of products in a hermetic package is specifically designed for use at power switching frequencies in excess of 100 kHz. The series combines two high efficiency devices into one package, simplifying installation, reducing heat sink hardware, and the need to obtain matched components. These devices are ideally suited for Hi-Rel applications where small size and a hermetically sealed package is required.

## ABSOLUTE MAXIMUM RATINGS (Per Diode) @ 25°C

Peak Inverse Voltage . . . . . 50 to 600 V  
 Maximum Average D.C. Output Current @  $T_C = 100^\circ\text{C}$  . . . . . 12 A  
 Non-Repetitive Sinusoidal Surge Current 8.3 ms . . . . . 100 A  
 Operating and Storage Temperature Range . . . . . - 55° C to + 150° C

3.2

### SCHEMATIC

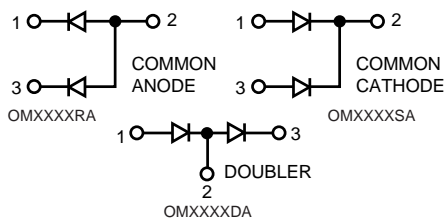

Common cathode is standard. Contact the factory for performance characteristics for common anode and doubler.

Standard Products are supplied with glass feedthroughs.  
 For ceramic feedthroughs, add the letter "C" to the part number.  
 Example - OMXXXXCSA.  
 Z-Tab package also available.

### MECHANICAL OUTLINE

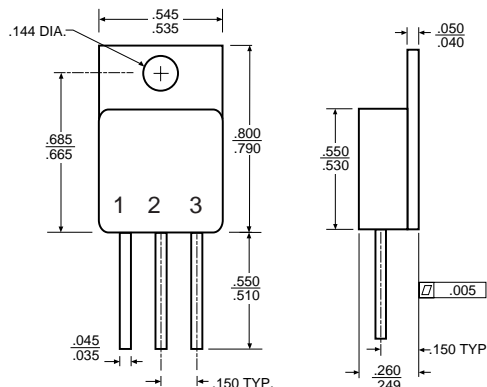

OM5221SA/RA/DA - OM5226SA/RA/DA

**ELECTRICAL CHARACTERISTICS (Per Diode)**

Type	PIV	Maximum Forward Voltage (Volts) @ <sup>(1)</sup>		Maximum Reverse Current @ PIV		Maximum Reverse Recovery Time <sup>(2)</sup>	Maximum Thermal Resist. $R_{\theta JC}$
		$T_j = 25^\circ\text{C}$	$T_j = 100^\circ\text{C}$	$T_j = 25^\circ\text{C}$	$T_j = 100^\circ\text{C}$		
OM5221XX	50	1.05V @ 12A	0.98V @ 12A	20 $\mu\text{A}$	1.0 mA	35 nsec	2.0
OM5222XX	100						
OM5223XX	150						
OM5224XX	200						
OM5225XX	400	1.35V @ 12A	1.15V @ 12A	20 $\mu\text{A}$	1.0 mA	50 nsec	1.8
OM5226XX	600	1.6V @ 12A	1.4V @ 12A	20 $\mu\text{A}$	2.0 mA	50 nsec	

(1) Pulse Test: Pulse Width = 300 $\mu\text{s}$ , Duty Cycle = 2.0%. (2) Measured in Circuit:  $I_F = 0.5\text{ A}$ ,  $I_R = 1.0\text{ A}$ ,  $I_{REC} = 0.25\text{ A}$

**50 V TO 200 V  
TYPICAL FORWARD VOLTAGE  
OM5221, 5222, 5223, 5224**

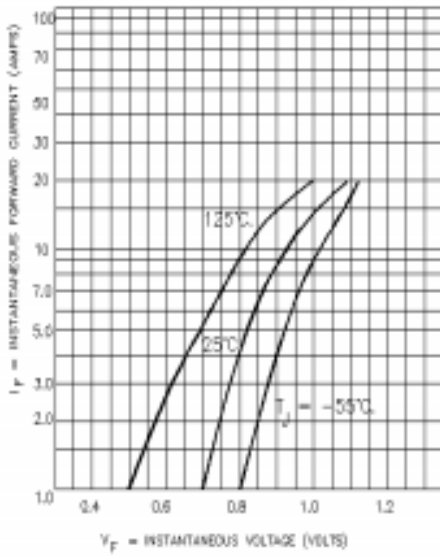

**400 V  
TYPICAL FORWARD VOLTAGE  
OM5225**

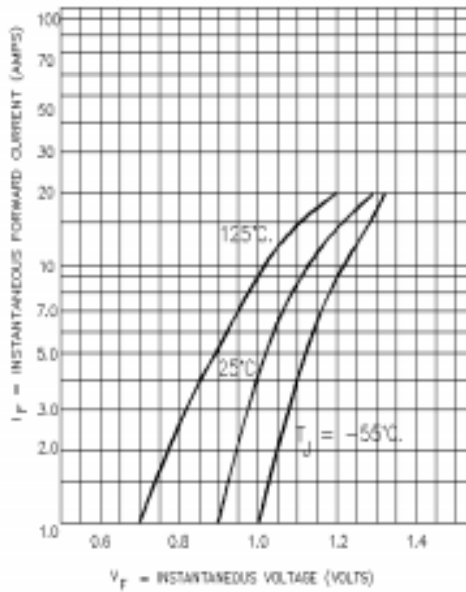

**TYPICAL REVERSE CURRENT  
OM5221, 5222, 5223, 5224**

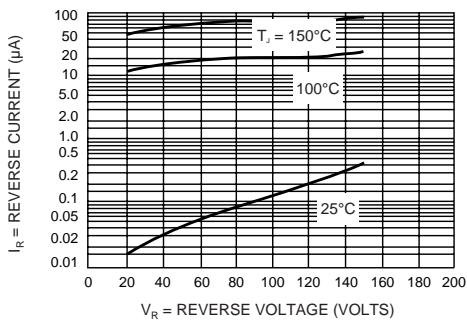

**TYPICAL REVERSE CURRENT  
OM5225**

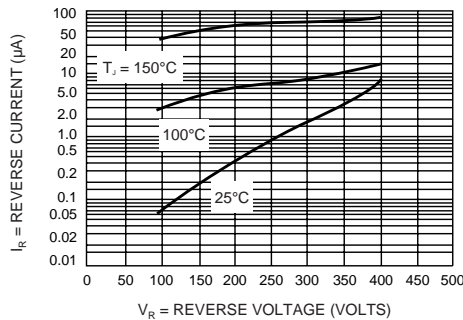

3.2