

1.5 AMP LOW DROPOUT POSITIVE ADJUSTABLE REGULATOR APPROVED TO DESC DRAWING 5962-89981

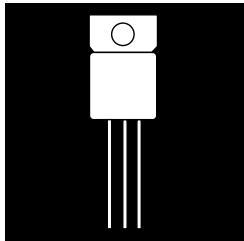

**Three Terminal, Positive Adjustable
Low Dropout Voltage Regulator In
Hermetic Packages**

FEATURES

- Similar To Industry Standard LT1086
- Approved To DESC Standardized Military Drawing Number 5962-89981
- Adjustable Output Voltage
- Built In Thermal Overload Protection
- Short Circuit Current Limiting
- Maximum Output Voltage Tolerance is Guaranteed To $\pm 1\%$
- Guaranteed Dropout Voltage At Multiple Current Levels
- TO-257 Available in Isolated and Non-Isolated Packages

DESCRIPTION

This three terminal positive adjustable voltage regulator is designed to provide 1.5A with higher efficiency than conventional voltage regulators. This device is designed to operate to 1 Volt input to output differential and the dropout voltage is specified as a function of load current. Supplied in easy-to-use hermetic TO-257, TO-3 and TO-39 packages, this device is ideally suited for Military applications where small size and high reliability is required.

ABSOLUTE MAXIMUM RATINGS @ 25°C

Power Dissipation (P_d)	Internally Limited
Input - Output Voltage Differential	35 V
Operating Junction Temperature Range	- 55°C to + 150°C
Storage Temperature Range	- 65°C to + 150°C
Lead Temperature (Soldering 10 seconds)	300°C
Thermal Resistance:	
θ_{JC} (TO-257, Isolated)	4.2°C/W
θ_{JA}	42°C/W
θ_{JC} (TO-3)	3.0°C/W
θ_{JA} (TO-3)	35°C/W
θ_{JC} (TO-39)	40°C/W
θ_{JA} (TO-39)	140°C/W
Maximum Output Current	1.5 A
Recommended Operating Conditions:	
Output Voltage Range	.3.3V to 15 V
Ambient Operating Temperature Range (T_A)	- 55°C to + 125°C
Input Voltage Range	5V to 25 V

3.3

OM1860STM OM1860NKM OM1860NHM

ELECTRICAL CHARACTERISTICS -55°C ≤ T_A ≤ 125°C (unless otherwise specified)

Parameter	Symbol	Test Conditions	Min.	Max.	Unit
Reference Voltage	V _{REF}	V _{IN} - V _{OUT} = 3.0 V, T _A = 25° C I _{OUT} = 10 mA	1.238	1.262	V
		1.5 V ≤ V _{IN} - V _{OUT} ≤ 25 V, 10 mA ≤ I _{OUT} ≤ 1.0 A	• 1.220	1.270	V
Line Regulation (Note 1)	$\frac{\Delta V_{OUT}}{\Delta V_{IN}}$	1.5 V ≤ V _{IN} - V _{OUT} ≤ 15 V, I _{OUT} = 10 mA, T _A = 25° C		0.2	%
		15 V ≤ V _{IN} - V _{OUT} ≤ 35 V, I _{OUT} = 10 mA	•	0.5	%
Load Regulation (Note 1)	$\frac{\Delta V_{OUT}}{\Delta I_{OUT}}$	V _{IN} - V _{OUT} = 3.0 V, T _A = 25° C 10 mA ≤ I _{OUT} ≤ 1.0 A		0.8	%
			•	1.0	%
Dropout Voltage	V _{DO}	I _{OUT} = 1.0 A, ΔV _{REF} = 1%	•	1.5	V
Thermal Regulation	-	30 ms pulse, T _A = +25° C		0.04	%/W
Ripple Rejection	$\frac{\Delta V_{IN}}{\Delta V_{OUT}}$	f = 120 Hz, C _{Adj} = 25 μF, C _{OUT} = 25 μF (tantalum), I _{OUT} = 1.0 A, V _{IN} - V _{OUT} = 3.0 V	• 60		dB
Adjust Pin Current	I _{Adj}	1.5 V ≤ V _{IN} - V _{OUT} ≤ 25 V, 10 mA ≤ I _{OUT} ≤ 1.0 A	•	120	μA
Adjust Pin Current Change	ΔI _{Adj}	1.5 V ≤ V _{IN} - V _{OUT} ≤ 25 V, 10 mA ≤ I _{OUT} ≤ 1.0 A	•	5.0	μA
Minimum Load Current	I _{Min}	V _{IN} - V _{OUT} = 25 V	•	10	mA
Current Limit	I _{Lim}	V _{IN} - V _{OUT} ≤ 5.0 V	• 1.5	2.5	A
		V _{IN} - V _{OUT} = 25 V	• 0.075		A
Temperature Stability (Note 2)	$\frac{\Delta V_{OUT}}{\Delta T}$	-55° C ≤ T _J ≤ +125° C	•	1.5	%
Long Term Stability (Note 2)	$\frac{\Delta V_{OUT}}{\Delta T}$	T _A = +125° C, t = 1000 hrs		1.0	%

Notes:

- Line and Load Regulation are measured at a constant junction temperature using a low duty cycle pulse technique. Although power dissipation is internally limited, regulation is guaranteed up to the maximum power dissipation of 15 W. Power dissipation is determined by the input/output differential voltage and the output current. Guaranteed maximum power dissipation will not be available over the full input/output voltage range.
- Guaranteed by design, characterization or correlation to other tested parameters.
- The • denotes the specifications which apply over the full operating temperature range.

3.3

PART NUMBER DESIGNATOR		
Standard Military Drawing Number	Omnirel Part Number	Package
5962-8998101Y	OM1860NHM	TO-39
5962-8998101X	OM1860NKM	TO-3
5962-8998101U	OM1860STM	TO-257 (Isolated)

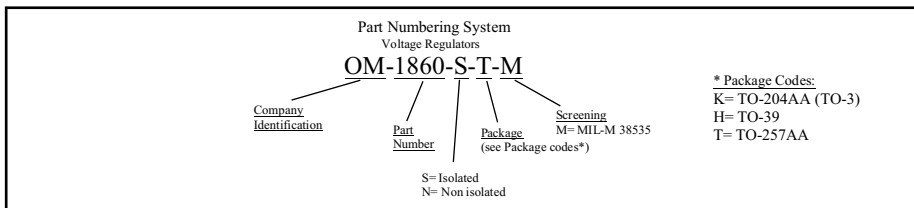

LOAD REGULATION

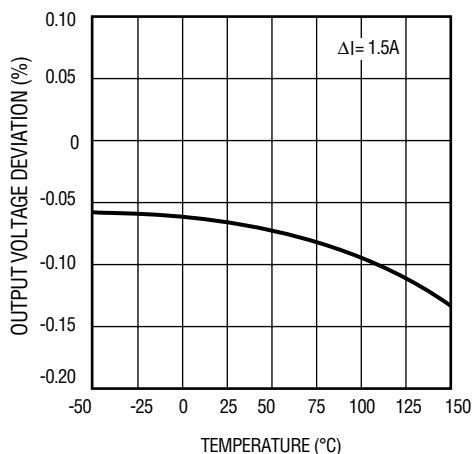

SHORT CIRCUIT CURRENT

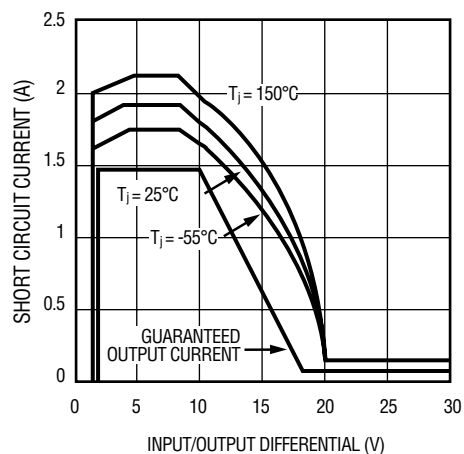

ADJUSTMENT PIN CURRENT

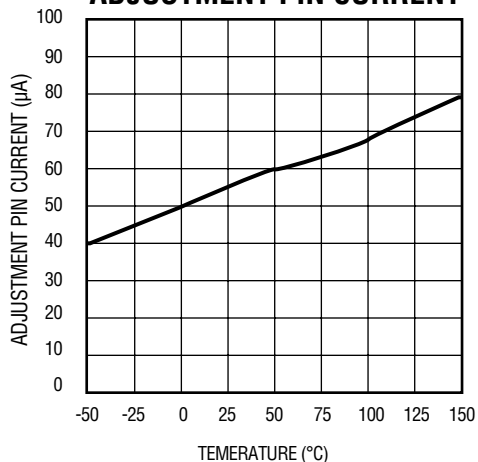

RIPPLE REJECTION VS. CURRENT

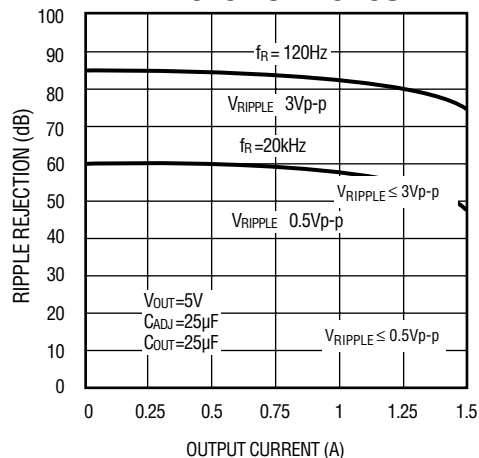

TEMPERATURE STABILITY

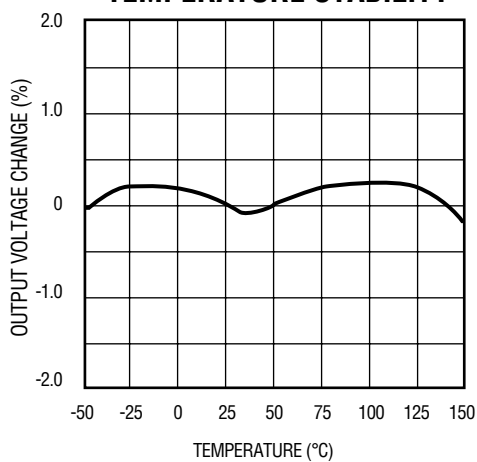

MINIMUM OPERATING CURRENT

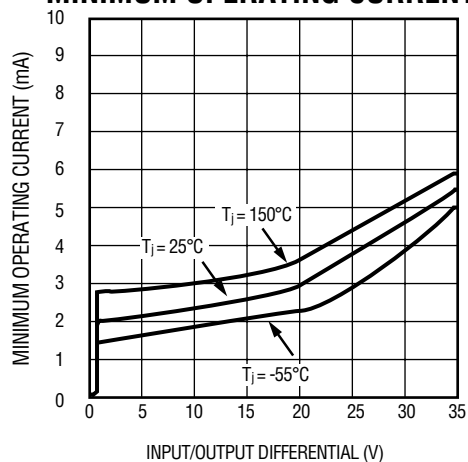

TYPICAL APPLICATIONS

1.2V - 15V Adjustable Regulator

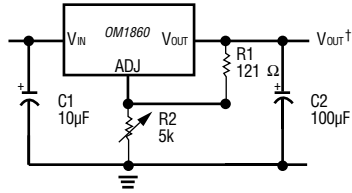

*NEEDED IF DEVICE IS FAR FROM FILTER CAPACITORS

$$V_{OUT} = 1.25V \left(1 + \frac{R2}{R1}\right)$$

5V Regulator with Shutdown

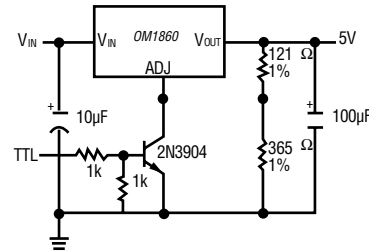

MECHANICAL OUTLINE OM1860STM

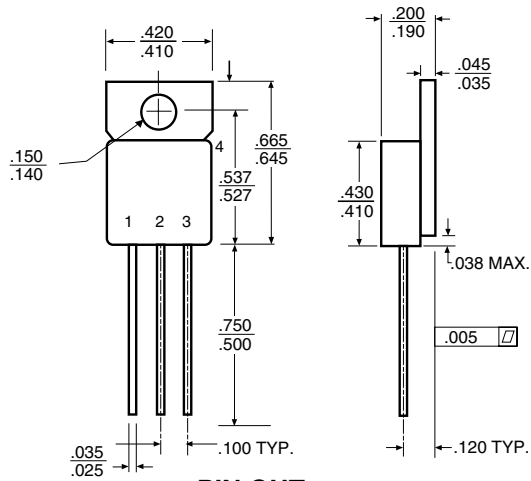

PIN OUT
 1 Adjust
 2 V_{OUT}
 3 V_{IN}
 4 Isolated

NOTES

- Case is metal/hermetically sealed
- Isolated Tab

MECHANICAL OUTLINE TO-3 OM1860NKM

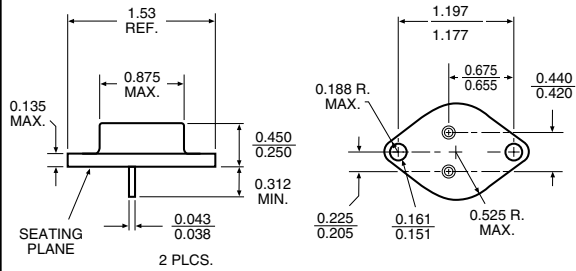

PIN OUT

1 Adjust
 2 V_{IN}
 Case V_{OUT}

MECHANICAL OUTLINE TO-39

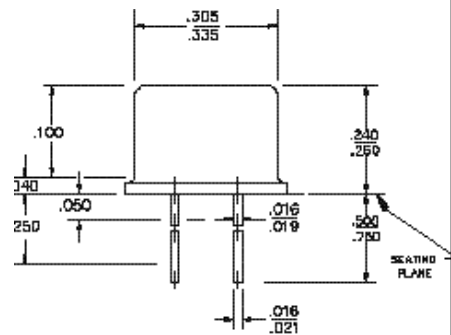

OM1860NHM TO-39

Pin 1 Adjust
 Pin 2 Input
 Case Output

