

FOUR N-CHANNEL MOSFETS IN HERMETIC POWER PACKAGE

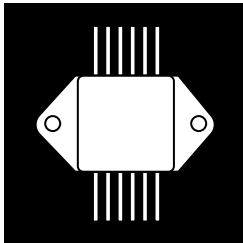

100V Thru 500V, Up To 25 Amp, N-Channel MOSFET In Hermetic Metal Package

FEATURES

- Isolated Hermetic Metal Package
- Fast Switching
- Low $R_{DS(on)}$
- Available Screened To MIL-S-19500, TX, TXV and S Levels

DESCRIPTION

This series of hermetically packaged products feature the latest advanced MOSFET and packaging technology. They are ideally suited for Military requirements where small size, high performance and high reliability are required, and in applications such as switching power supplies, motor controls, inverters, choppers, audio amplifiers and high energy pulse circuits.

MAXIMUM RATINGS PER TRANSISTOR @ 25°C

PART NUMBER	V_{DS}	$R_{DS(on)}$	I_D
OMD100	100V	.08	25A
OMD200	200V	.11	25A
OMD400	400V	.35	13A
OMD500	500V	.43	11A

3.1

SCHEMATIC

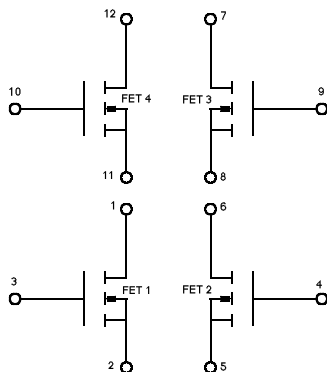

CONNECTION DIAGRAM

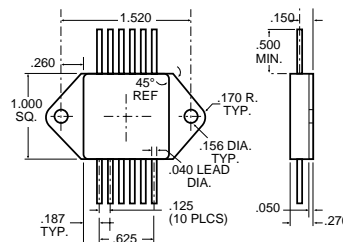
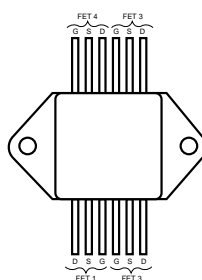

ELECTRICAL CHARACTERISTICS: (T_C = 25°C unless otherwise noted)
STATIC P/N OMD100 (100V)

Parameter	Min.	Typ.	Max.	Units	Test Conditions
BV _{DSS} Drain-Source Breakdown Voltage	100			V	V _{GS} = 0, I _D = 250 mA
V _{GS(th)} Gate-Threshold Voltage	2.0		4.0	V	V _{DS} = V _{GS} , I _D = 250 mA
I _{GSSF} Gate-Body Leakage Forward			100	nA	V _{GS} = +20 V
I _{GSSR} Gate-Body Leakage Reverse			- 100	nA	V _{GS} = -20 V
I _{DSS} Zero Gate Voltage Drain Current		0.1	0.25	mA	V _{DS} = Max. Rat., V _{GS} = 0
		0.2	1.0	mA	V _{DS} = 0.8 Max. Rat., V _{GS} = 0, T _C = 125° C
I _{D(on)} On-State Drain Current ¹	35			A	V _{DS} = 2 V _{DS(on)} , V _{GS} = 10 V
V _{DS(on)} Static Drain-Source On-State Voltage ¹		1.1	1.60	V	V _{GS} = 10 V, I _D = 20 A
R _{DS(on)} Static Drain-Source On-State Resistance ¹		.065	.080		V _{GS} = 10 V, I _D = 20 A
R _{DS(on)} Static Drain-Source On-State Resistance ¹		.10	.160		V _{GS} = 10 V, I _D = 20 A, T _C = 125 C

DYNAMIC

g _{fs} Forward Transconductance ¹	9.0	10		S (M)	V _{DS} = 2 V _{DS(on)} , I _D = 20 A
C _{iss} Input Capacitance		2700		pF	V _{GS} = 0
C _{oss} Output Capacitance		1300		pF	V _{DS} = 25 V
C _{rss} Reverse Transfer Capacitance		470		pF	f = 1 MHz
t _{d(on)} Turn-On Delay Time		28		ns	V _{DD} = 30 V, I _D @ 20 A
t _r Rise Time		45		ns	R _g = 5.0 Ω, V _G = 10V
t _{d(off)} Turn-Off Delay Time		100		ns	(MOSFET switching times are essentially independent of operating temperature.)
t _f Fall Time		50		ns	

BODY-DRAIN DIODE RATINGS AND CHARACTERISTICS

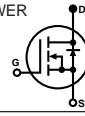
I _S Continuous Source Current (Body Diode)			- 40	A	Modified MOSPOWER symbol showing the integral P-N Junction rectifier. 
I _{SM} Source Current ¹ (Body Diode)			- 160	A	
V _{SD} Diode Forward Voltage ¹			- 2.5	V	T _C = 25 C, I _S = -40 A, V _{GS} = 0
t _{rr} Reverse Recovery Time		400		ns	T _J = 150 C, I _F = I _S , dI _F /ds = 100 A/ms

1 Pulse Test: Pulse Width 300msec, Duty Cycle 2%.

ELECTRICAL CHARACTERISTICS: (T_C = 25°C unless otherwise noted)
STATIC P/N OMD200 (200V)

Parameter	Min.	Typ.	Max.	Units	Test Conditions
BV _{DSS} Drain-Source Breakdown Voltage	200			V	V _{GS} = 0, I _D = 250 mA
V _{GS(th)} Gate-Threshold Voltage	2.0		4.0	V	V _{DS} = V _{GS} , I _D = 250 mA
I _{GSSF} Gate-Body Leakage Forward			100	nA	V _{GS} = +20 V
I _{GSSR} Gate-Body Leakage Reverse			-100	nA	V _{GS} = -20 V
I _{DSS} Zero Gate Voltage Drain Current		0.1	0.25	mA	V _{DS} = Max. Rat., V _{GS} = 0
		0.2	1.0	mA	V _{DS} = 0.8 Max. Rat., V _{GS} = 0, T _C = 125° C
I _{D(on)} On-State Drain Current ¹	30			A	V _{DS} = 2 V _{DS(on)} , V _{GS} = 10 V
V _{DS(on)} Static Drain-Source On-State Voltage ¹		1.36	1.76	V	V _{GS} = 10 V, I _D = 16 A
R _{DS(on)} Static Drain-Source On-State Resistance ¹		.085	.110		V _{GS} = 10 V, I _D = 16 A
R _{DS(on)} Static Drain-Source On-State Resistance ¹		0.14	.200		V _{GS} = 10 V, I _D = 16 A, T _C = 125 C

DYNAMIC

g _{fs} Forward Transconductance ¹	10.0	12.5		S (M)	V _{DS} = 2 V _{DS(on)} , I _D = 16 A
C _{iss} Input Capacitance		2400		pF	V _{GS} = 0
C _{oss} Output Capacitance		600		pF	V _{DS} = 25 V
C _{rss} Reverse Transfer Capacitance		250		pF	f = 1 MHz
t _{d(on)} Turn-On Delay Time		25		ns	V _{DD} = 75 V, I _D @ 16 A
t _r Rise Time		60		ns	R _g = 5.0 Ω, V _{GS} = 10V
t _{d(off)} Turn-Off Delay Time		85		ns	(MOSFET switching times are essentially independent of operating temperature.)
t _f Fall Time		38		ns	

BODY-DRAIN DIODE RATINGS AND CHARACTERISTICS

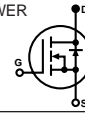
I _S Continuous Source Current (Body Diode)			- 30	A	Modified MOSPOWER symbol showing the integral P-N Junction rectifier. 
I _{SM} Source Current ¹ (Body Diode)			- 120	A	
V _{SD} Diode Forward Voltage ¹			- 2	V	T _C = 25 C, I _S = -30 A, V _{GS} = 0
t _{rr} Reverse Recovery Time		350		ns	T _J = 150 C, I _F = I _S , dI _F /ds = 100 A/ms

1 Pulse Test: Pulse Width 300msec, Duty Cycle 2%.

ELECTRICAL CHARACTERISTICS: ($T_C = 25^\circ\text{C}$ unless otherwise noted)
STATIC P/N OMD400 (400V)

Parameter	Min.	Typ.	Max.	Units	Test Conditions
BV_{DSS} Drain-Source Breakdown Voltage	400			V	$V_{GS} = 0$, $I_D = 250\text{ mA}$
$V_{GS(th)}$ Gate-Threshold Voltage	2.0		4.0	V	$V_{DS} = V_{GS}$, $I_D = 250\text{ mA}$
I_{GSSF} Gate-Body Leakage Forward			100	nA	$V_{GS} = +20\text{ V}$
I_{GSSR} Gate-Body Leakage Reverse			- 100	nA	$V_{GS} = -20\text{ V}$
I_{DSS} Zero Gate Voltage Drain Current		0.1	0.25	mA	$V_{DS} = \text{Max. Rat.}$, $V_{GS} = 0$
		0.2	1.0	mA	$V_{DS} = 0.8\text{ Max. Rat.}$, $V_{GS} = 0$, $T_C = 125^\circ\text{ C}$
$I_{D(on)}$ On-State Drain Current ¹	15			A	$V_{DS} = 2 V_{DS(on)}$, $V_{GS} = 10\text{ V}$
$V_{DS(on)}$ Static Drain-Source On-State Voltage ¹		2.0	2.8	V	$V_{GS} = 10\text{ V}$, $I_D = 8.0\text{ A}$
$R_{DS(on)}$ Static Drain-Source On-State Resistance ¹		0.30	.35		$V_{GS} = 10\text{ V}$, $I_D = 8.0\text{ A}$
$R_{DS(on)}$ Static Drain-Source On-State Resistance ¹		.60	.70		$V_{GS} = 10\text{ V}$, $I_D = 8.0\text{ A}$, $T_C = 125\text{ C}$

DYNAMIC

g_{fs} Forward Transconductance ¹	6.0	9.6		S (M)	$V_{DS} = 2 V_{DS(on)}$, $I_D = 8.0\text{ A}$
C_{iss} Input Capacitance		2900		pF	$V_{GS} = 0$
C_{oss} Output Capacitance		450		pF	$V_{DS} = 25\text{ V}$
C_{riss} Reverse Transfer Capacitance		150		pF	$f = 1\text{ MHz}$
$t_{d(on)}$ Turn-On Delay Time		30		ns	$V_{DD} = 200\text{ V}$, $I_D @ 8.0\text{ A}$
t_r Rise Time		40		ns	$R_{\theta} = 5.0\text{ W}$, $V_{GS} = 10\text{ V}$
$t_{d(off)}$ Turn-Off Delay Time		80		ns	(MOSFET switching times are essentially independent of operating temperature.)
t_f Fall Time		30		ns	

BODY-DRAIN DIODE RATINGS AND CHARACTERISTICS

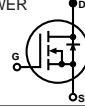
I_S Continuous Source Current (Body Diode)			- 15	A	Modified MOSPOWER symbol showing the integral P-N Junction rectifier. 
I_{SM} Source Current ¹ (Body Diode)			- 60	A	
V_{SD} Diode Forward Voltage ¹			- 1.6	V	$T_C = 25\text{ C}$, $I_S = -15\text{ A}$, $V_{GS} = 0$
t_{rr} Reverse Recovery Time		600		ns	$T_J = 100\text{ C}$, $I_F = I_S$, $di_F/ds = 100\text{ A}/\mu\text{s}$

1 Pulse Test: Pulse Width 300msec, Duty Cycle 2%.

ELECTRICAL CHARACTERISTICS: ($T_C = 25^\circ\text{C}$ unless otherwise noted)
STATIC P/N OMD500 (500V)

Parameter	Min.	Typ.	Max.	Units	Test Conditions
BV_{DSS} Drain-Source Breakdown Voltage	500			V	$V_{GS} = 0$, $I_D = 250\text{ mA}$
$V_{GS(th)}$ Gate-Threshold Voltage	2.0		4.0	V	$V_{DS} = V_{GS}$, $I_D = 250\text{ mA}$
I_{GSSF} Gate-Body Leakage Forward			100	nA	$V_{GS} = +20\text{ V}$
I_{GSSR} Gate-Body Leakage Reverse			- 100	nA	$V_{GS} = -20\text{ V}$
I_{DSS} Zero Gate Voltage Drain Current		0.1	0.25	mA	$V_{DS} = \text{Max. Rat.}$, $V_{GS} = 0$
		0.2	1.0	mA	$V_{DS} = 0.8\text{ Max. Rat.}$, $V_{GS} = 0$, $T_C = 125^\circ\text{ C}$
$I_{D(on)}$ On-State Drain Current ¹	13			A	$V_{DS} = 2 V_{DS(on)}$, $V_{GS} = 10\text{ V}$
$V_{DS(on)}$ Static Drain-Source On-State Voltage ¹		2.1	3.0	V	$V_{GS} = 10\text{ V}$, $I_D = 7.0\text{ A}$
$R_{DS(on)}$ Static Drain-Source On-State Resistance ¹		0.35	0.43		$V_{GS} = 10\text{ V}$, $I_D = 7.0\text{ A}$
$R_{DS(on)}$ Static Drain-Source On-State Resistance ¹		0.66	0.88		$V_{GS} = 10\text{ V}$, $I_D = 7.0\text{ A}$, $T_C = 125\text{ C}$

DYNAMIC

g_{fs} Forward Transconductance ¹	6.0	7.2		S (M)	$V_{DS} = 2 V_{DS(on)}$, $I_D = 7.0\text{ A}$
C_{iss} Input Capacitance		2600		pF	$V_{GS} = 0$
C_{oss} Output Capacitance		280		pF	$V_{DS} = 25\text{ V}$
C_{riss} Reverse Transfer Capacitance		40		pF	$f = 1\text{ MHz}$
$t_{d(on)}$ Turn-On Delay Time		30		ns	$V_{DD} = 210\text{ V}$, $I_D @ 7.0\text{ A}$
t_r Rise Time		46		ns	$R_{\theta} = 5.0\text{ W}$, $V_{GS} = 10\text{ V}$
$t_{d(off)}$ Turn-Off Delay Time		75		ns	(MOSFET switching times are essentially independent of operating temperature.)
t_f Fall Time		31		ns	

BODY-DRAIN DIODE RATINGS AND CHARACTERISTICS

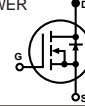
I_S Continuous Source Current (Body Diode)			- 13	A	Modified MOSPOWER symbol showing the integral P-N Junction rectifier. 
I_{SM} Source Current ¹ (Body Diode)			- 52	A	
V_{SD} Diode Forward Voltage ¹			- 1.4	V	$T_C = 25\text{ C}$, $I_S = -13\text{ A}$, $V_{GS} = 0$
t_{rr} Reverse Recovery Time		700		ns	$T_J = 150\text{ C}$, $I_F = I_S$, $di_F/ds = 100\text{ A}/\mu\text{s}$

1 Pulse Test: Pulse Width 300msec, Duty Cycle 2%.

OMD100 - OMD500

ABSOLUTE MAXIMUM RATINGS ($T_C = 25^\circ\text{C}$ unless otherwise noted)

Parameter	OMD100	OMD200	OMD400	OMD500	Units
V_{DS} Drain-Source Voltage	100	200	400	500	V
V_{DGR} Drain-Gate Voltage ($R_{GS} = 1\text{ M}$)	100	200	400	500	V
$I_D @ T_C = 25^\circ\text{C}$ Continuous Drain Current ²	± 25	± 25	± 13	± 11	A
$I_D @ T_C = 100^\circ\text{C}$ Continuous Drain Current ²	± 16	± 16	± 8	± 7	A
I_{DM} Pulsed Drain Current ¹	± 100	± 80	± 54	± 40	A
V_{GS} Gate-Source Voltage	± 20	± 20	± 20	± 20	V
$P_D @ T_C = 25^\circ\text{C}$ Maximum Power Dissipation	125	125	125	125	W
$P_D @ T_C = 100^\circ\text{C}$ Maximum Power Dissipation	50	50	50	50	W
Junction To Case Linear Derating Factor	1.0	1.0	1.0	1.0	W/ $^\circ\text{C}$
Junction To Ambient Linear Derating Factor	.033	.033	.033	.033	W/ $^\circ\text{C}$
T_J Operating and T_{stg} Storage Temperature Range	-55 to 150	-55 to 150	-55 to 150	-55 to 150	$^\circ\text{C}$
Lead Temperature (1/16" from case for 10 secs.)	300	300	300	300	$^\circ\text{C}$

1 Pulse Test: Pulse width 300 μsec . Duty Cycle 2%.

2 Package pin limitation = 10 Amps

THERMAL RESISTANCE

R_{thJC} Junction-to-Case	1.0	$^\circ\text{C}/\text{W}$	
R_{thJA} Junction-to-Ambient	30	$^\circ\text{C}/\text{W}$	Free Air Operation

POWER DERATING

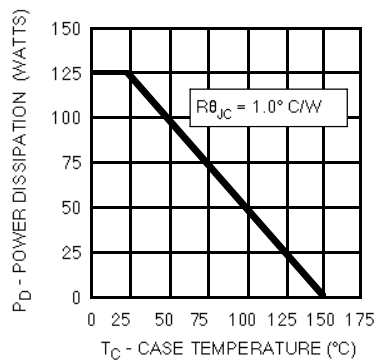

PACKAGE OPTIONS

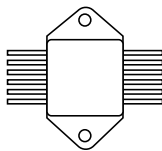

MOD PAK

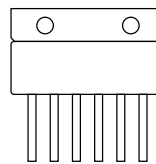

6 PIN SIP

Note: MOSFETs are also available in Z-Tab, dual and quad pak styles. Please call the factory for more information.