

Designer's™ Data Sheet

SWITCHMODE™

NPN Bipolar Power Transistor

For Switching Power Supply Applications

The BUL146/BUL146F have an applications specific state-of-the-art die designed for use in fluorescent electric lamp ballasts to 130 Watts and in Switchmode Power supplies for all types of electronic equipment. These high voltage/high speed transistors offer the following:

- Improved Efficiency Due to Low Base Drive Requirements:
 - High and Flat DC Current Gain
 - Fast Switching
 - No Coil Required in Base Circuit for Turn-Off (No Current Tail)
- Full Characterization at 125°C
- Parametric Distributions are Tight and Consistent Lot-to-Lot
- Two Package Choices: Standard TO-220 or Isolated TO-220
- BUL146F, Isolated Case 221D, is UL Recognized to 3500 VRMS: File #E69369

MAXIMUM RATINGS

Rating	Symbol	BUL146	BUL146F	Unit
Collector-Emitter Sustaining Voltage	V_{CEO}	400		Vdc
Collector-Emitter Breakdown Voltage	V_{CES}	700		Vdc
Emitter-Base Voltage	V_{EBO}	9.0		Vdc
Collector Current — Continuous	I_C	6.0		Adc
— Peak(1)	I_{CM}	15		
Base Current — Continuous	I_B	4.0		Adc
— Peak(1)	I_{BM}	8.0		
RMS Isolated Voltage(2) (for 1 sec, R.H. < 30%, $T_C = 25^\circ\text{C}$)	Test No. 1 Per Fig. 22a	V_{ISOL}	4500	V
	Test No. 2 Per Fig. 22b		3500	
	Test No. 3 Per Fig. 22c		1500	
Total Device Dissipation ($T_C = 25^\circ\text{C}$) Derate above 25°C	P_D	100 0.8	40 0.32	Watts W/°C
Operating and Storage Temperature	T_J, T_{stg}	- 65 to 150		°C

THERMAL CHARACTERISTICS

Rating	Symbol	BUL146	BUL146F	Unit
Thermal Resistance — Junction to Case	$R_{\theta JC}$	1.25	3.125	°C/W
— Junction to Ambient	$R_{\theta JA}$	62.5	62.5	
Maximum Lead Temperature for Soldering Purposes: 1/8" from Case for 5 Seconds	T_L	260		°C

ELECTRICAL CHARACTERISTICS ($T_C = 25^\circ\text{C}$ unless otherwise noted)

Characteristic	Symbol	Min	Typ	Max	Unit
----------------	--------	-----	-----	-----	------

OFF CHARACTERISTICS

Collector-Emitter Sustaining Voltage ($I_C = 100\text{ mA}, L = 25\text{ mH}$)	$V_{CEO(sus)}$	400	—	—	Vdc
Collector Cutoff Current ($V_{CE} = \text{Rated } V_{CEO}, I_B = 0$)	I_{CEO}	—	—	100	μAdc
Collector Cutoff Current ($V_{CE} = \text{Rated } V_{CES}, V_{EB} = 0$) ($T_C = 125^\circ\text{C}$) ($V_{CE} = 500\text{ V}, V_{EB} = 0$) ($T_C = 125^\circ\text{C}$)	I_{CES}	—	—	100	μAdc
		—	—	500	
		—	—	100	
Emitter Cutoff Current ($V_{EB} = 9.0\text{ Vdc}, I_C = 0$)	I_{EBO}	—	—	100	μAdc

(1) Pulse Test: Pulse Width = 5.0 ms, Duty Cycle $\leq 10\%$.

(2) Proper strike and creepage distance must be provided.

(continued)

Designer's and SWITCHMODE are trademarks of Motorola, Inc.

Designer's Data for "Worst Case" Conditions — The Designer's Data Sheet permits the design of most circuits entirely from the information presented. SOA Limit curves — representing boundaries on device characteristics — are given to facilitate "worst case" design.

Preferred devices are Motorola recommended choices for future use and best overall value.

REV 1

BUL146*
BUL146F*

*Motorola Preferred Device

POWER TRANSISTOR
6.0 AMPERES
700 VOLTS
40 and 100 WATTS

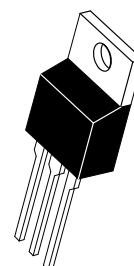

BUL146
CASE 221A-06
TO-220AB

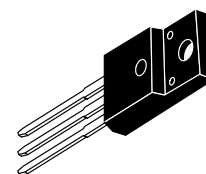

BUL146F
CASE 221D-02
ISOLATED TO-220 TYPE
UL RECOGNIZED

BUL146 BUL146F

ELECTRICAL CHARACTERISTICS — continued ($T_C = 25^\circ\text{C}$ unless otherwise noted)

Characteristic	Symbol	Min	Typ	Max	Unit
ON CHARACTERISTICS					
Base–Emitter Saturation Voltage ($I_C = 1.3 \text{ Adc}, I_B = 0.13 \text{ Adc}$) ($I_C = 3.0 \text{ Adc}, I_B = 0.6 \text{ Adc}$)	$V_{BE(sat)}$	— —	0.82 0.93	1.1 1.25	Vdc
Collector–Emitter Saturation Voltage ($I_C = 1.3 \text{ Adc}, I_B = 0.13 \text{ Adc}$) ($T_C = 125^\circ\text{C}$) ($I_C = 3.0 \text{ Adc}, I_B = 0.6 \text{ Adc}$) ($T_C = 125^\circ\text{C}$)	$V_{CE(sat)}$	— — —	0.22 0.20 0.30 0.30	0.5 0.5 0.7 0.7	Vdc
DC Current Gain ($I_C = 0.5 \text{ Adc}, V_{CE} = 5.0 \text{ Vdc}$) ($T_C = 125^\circ\text{C}$) ($I_C = 1.3 \text{ Adc}, V_{CE} = 1.0 \text{ Vdc}$) ($T_C = 125^\circ\text{C}$) ($I_C = 3.0 \text{ Adc}, V_{CE} = 1.0 \text{ Vdc}$) ($T_C = 125^\circ\text{C}$) ($I_C = 10 \text{ mAdc}, V_{CE} = 5.0 \text{ Vdc}$) ($T_C = 125^\circ\text{C}$)	h_{FE}	14 — 12 12 8.0 7.0 10	— 30 20 20 13 12 20	34 — — — — — —	—

DYNAMIC CHARACTERISTICS

Current Gain Bandwidth ($I_C = 0.5 \text{ Adc}, V_{CE} = 10 \text{ Vdc}, f = 1.0 \text{ MHz}$)	f_T	—	14	—	MHz		
Output Capacitance ($V_{CB} = 10 \text{ Vdc}, I_E = 0, f = 1.0 \text{ MHz}$)	C_{OB}	—	95	150	pF		
Input Capacitance ($V_{EB} = 8.0 \text{ V}$)	C_{IB}	—	1000	1500	pF		
Dynamic Saturation Voltage: Determined 1.0 μs and 3.0 μs respectively after rising I_{B1} reaches 90% of final I_{B1} (see Figure 18)	$I_C = 1.3 \text{ Adc}$ $I_{B1} = 300 \text{ mAdc}$ $V_{CC} = 300 \text{ V}$	1.0 μs	$(T_C = 125^\circ\text{C})$	— —	2.5 6.5	— —	V
		3.0 μs	$(T_C = 125^\circ\text{C})$	— —	0.6 2.5	— —	
	$I_C = 3.0 \text{ Adc}$ $I_{B1} = 0.6 \text{ Adc}$ $V_{CC} = 300 \text{ V}$	1.0 μs	$(T_C = 125^\circ\text{C})$	— —	3.0 7.0	— —	
		3.0 μs	$(T_C = 125^\circ\text{C})$	— —	0.75 1.4	— —	

SWITCHING CHARACTERISTICS: Resistive Load ($D.C. \leq 10\%$, Pulse Width = 20 μs)

Turn–On Time	$I_C = 1.3 \text{ Adc}, I_{B1} = 0.13 \text{ Adc}$ $I_{B2} = 0.65 \text{ Adc}, V_{CC} = 300 \text{ V}$ ($T_C = 125^\circ\text{C}$)	t_{on}	— —	100 90	200 —	ns
Turn–Off Time		t_{off}	— —	1.35 1.90	2.5 —	μs
Turn–On Time	$I_C = 3.0 \text{ Adc}, I_{B1} = 0.6 \text{ Adc}$ $I_{B1} = 1.5 \text{ Adc}, V_{CC} = 300 \text{ V}$ ($T_C = 125^\circ\text{C}$)	t_{on}	— —	90 100	150 —	ns
Turn–Off Time		t_{off}	— —	1.7 2.1	2.5 —	μs

SWITCHING CHARACTERISTICS: Inductive Load ($V_{clamp} = 300 \text{ V}, V_{CC} = 15 \text{ V}, L = 200 \mu\text{H}$)

Fall Time	$I_C = 1.3 \text{ Adc}, I_{B1} = 0.13 \text{ Adc}$ $I_{B2} = 0.65 \text{ Adc}$ ($T_C = 125^\circ\text{C}$)	t_{fi}	— —	115 120	200 —	ns
Storage Time		t_{si}	— —	1.35 1.75	2.5 —	μs
Crossover Time		t_c	— —	200 210	350 —	ns
Fall Time	$I_C = 3.0 \text{ Adc}, I_{B1} = 0.6 \text{ Adc}$ $I_{B2} = 1.5 \text{ Adc}$ ($T_C = 125^\circ\text{C}$)	t_{fi}	— —	85 100	150 —	ns
Storage Time		t_{si}	— —	1.75 2.25	2.5 —	μs
Crossover Time		t_c	— —	175 200	300 —	ns
Fall Time	$I_C = 3.0 \text{ Adc}, I_{B1} = 0.6 \text{ Adc}$ $I_{B2} = 0.6 \text{ Adc}$ ($T_C = 125^\circ\text{C}$)	t_{fi}	80 —	— 210	180 —	ns
Storage Time		t_{si}	2.6 —	— 4.5	3.8 —	μs
Crossover Time		t_c	— —	230 400	350 —	ns

TYPICAL STATIC CHARACTERISTICS

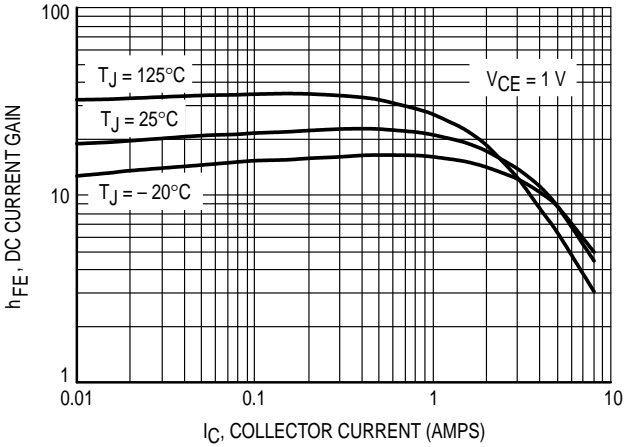

Figure 1. DC Current Gain @ 1 Volt

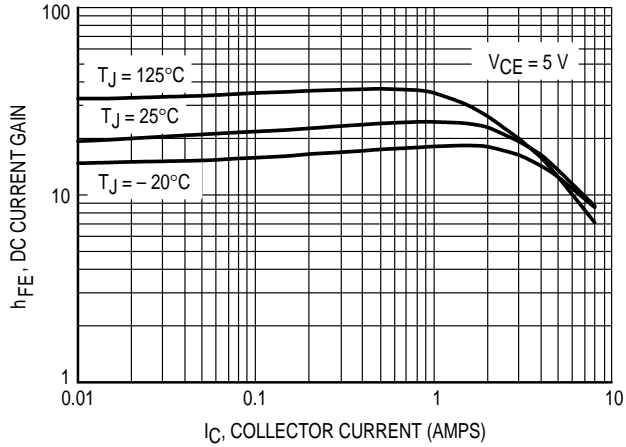

Figure 2. DC Current Gain @ 5 Volts

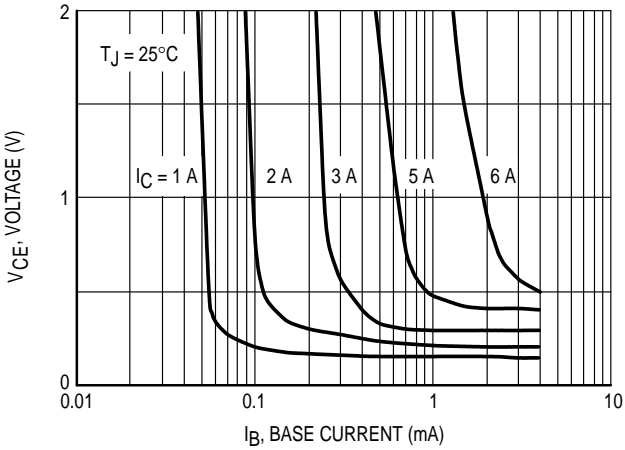

Figure 3. Collector Saturation Region

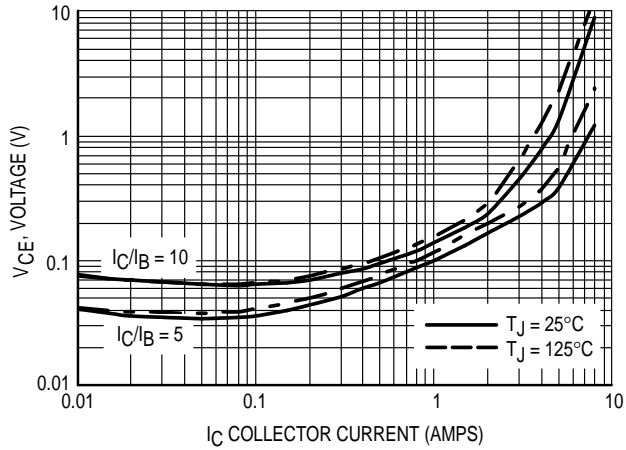

Figure 4. Collector-Emitter Saturation Voltage

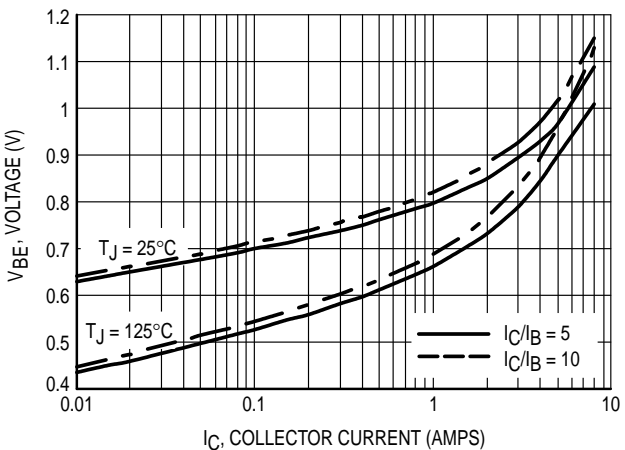

Figure 5. Base-Emitter Saturation Region

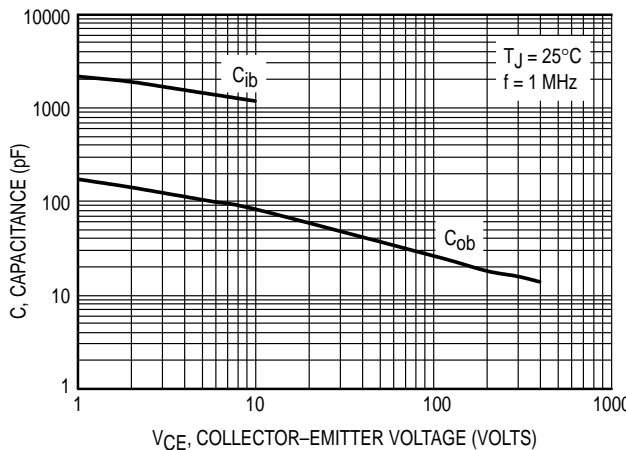

Figure 6. Capacitance

TYPICAL SWITCHING CHARACTERISTICS
($I_{B2} = I_C/2$ for all switching)

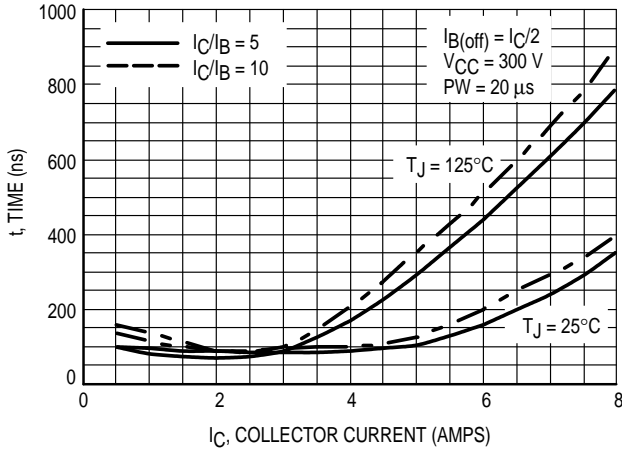

Figure 7. Resistive Switching, t_{on}

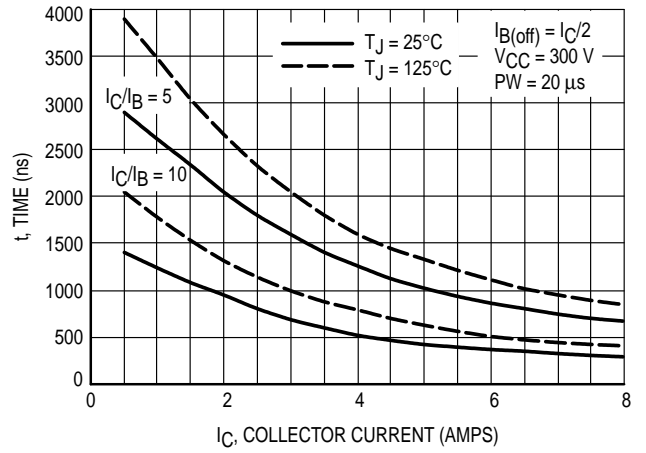

Figure 8. Resistive Switching, t_{off}

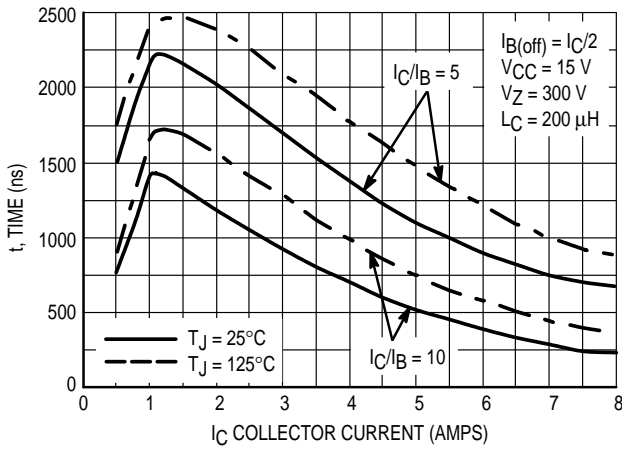

Figure 9. Inductive Storage Time, t_{si}

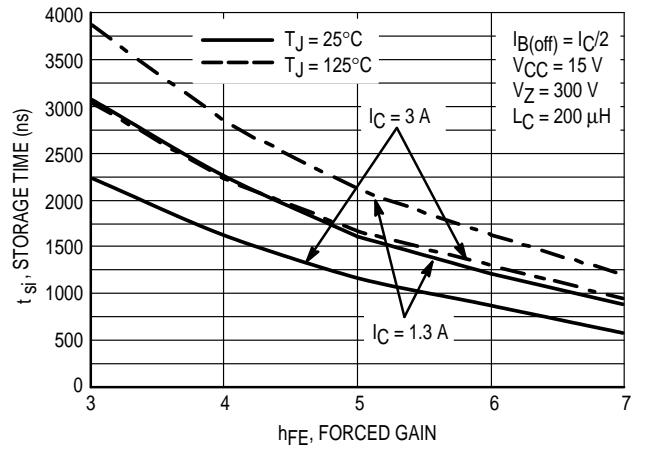

Figure 10. Inductive Storage Time, $t_{si}(h_{FE})$

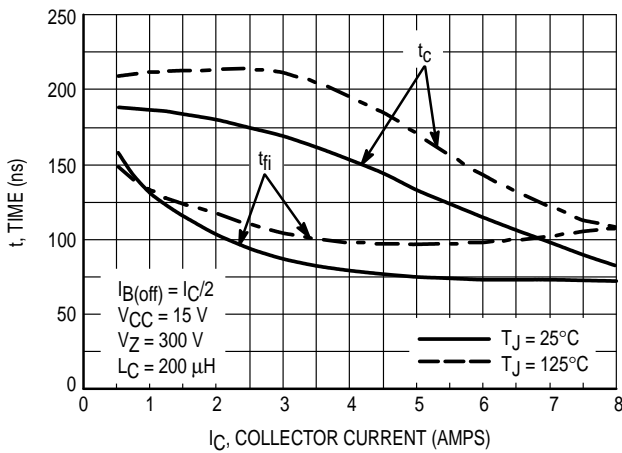

Figure 11. Inductive Switching, t_c and t_{fi}
 $I_C/I_B = 5$

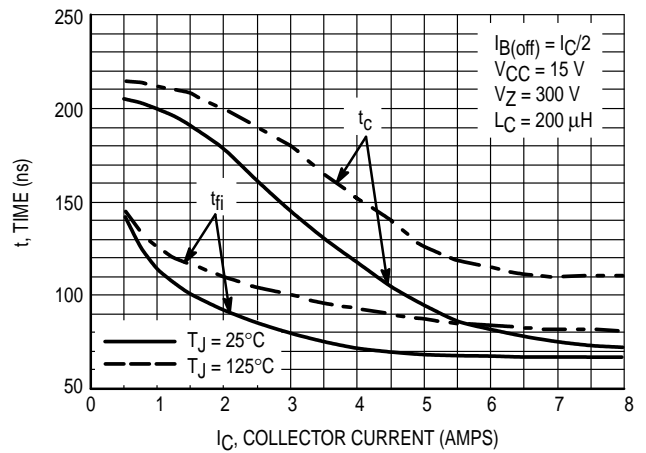

Figure 12. Inductive Switching, t_c and t_{fi}
 $I_C/I_B = 10$

TYPICAL SWITCHING CHARACTERISTICS
($I_{B2} = I_C/2$ for all switching)

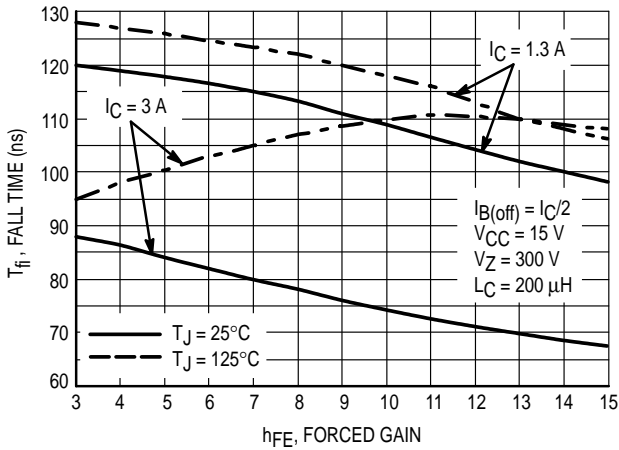

Figure 13. Inductive Fall Time

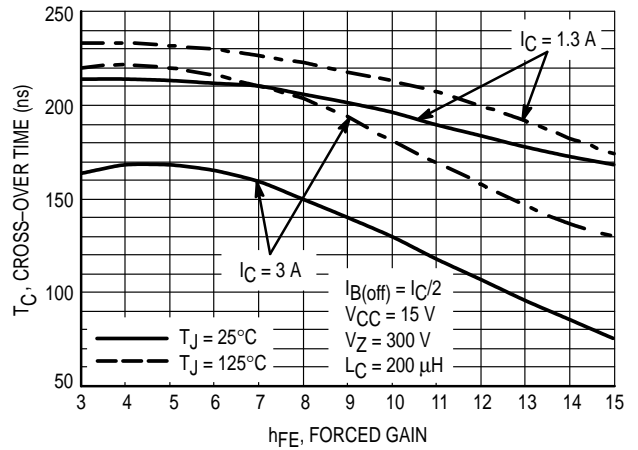

Figure 14. Inductive Cross-Over Time

GUARANTEED SAFE OPERATING AREA INFORMATION

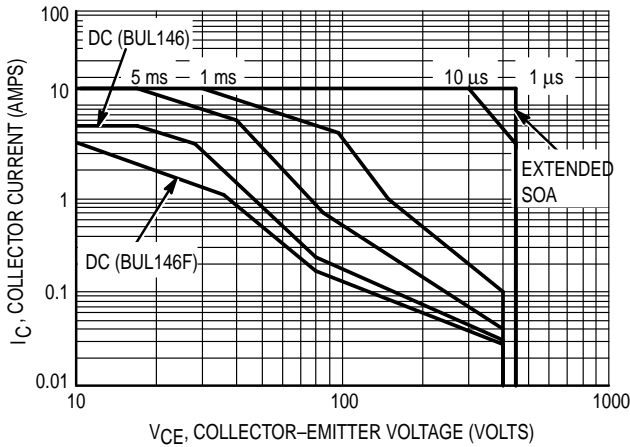

Figure 15. Forward Bias Safe Operating Area

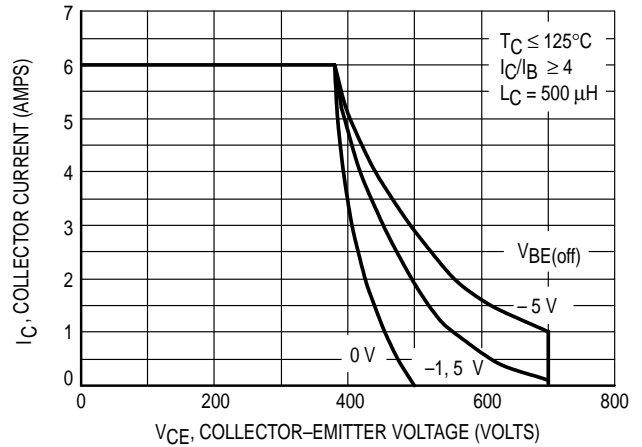

Figure 16. Reverse Bias Switching Safe Operating Area

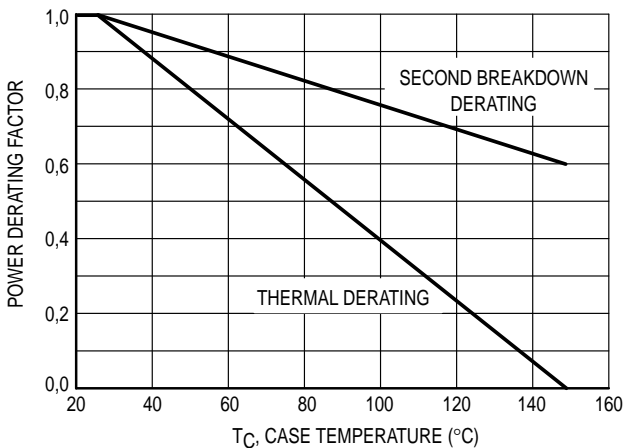

Figure 17. Forward Bias Power Derating

There are two limitations on the power handling ability of a transistor: average junction temperature and second breakdown. Safe operating area curves indicate $I_C - V_{CE}$ limits of the transistor that must be observed for reliable operation; i.e., the transistor must not be subjected to greater dissipation than the curves indicate. The data of Figure 15 is based on $T_C = 25^\circ\text{C}$; $T_{J(pk)}$ is variable depending on power level. Second breakdown pulse limits are valid for duty cycles to 10% but must be derated when $T_C > 25^\circ\text{C}$. Second breakdown limitations do not derate the same as thermal limitations. Allowable current at the voltages shown in Figure 15 may be found at any case temperature by using the appropriate curve on Figure 17. $T_{J(pk)}$ may be calculated from the data in Figure 20 and 21. At any case temperatures, thermal limitations will reduce the power that can be handled to values less than the limitations imposed by second breakdown. For inductive loads, high voltage and current must be sustained simultaneously during turn-off with the base-to-emitter junction reverse-biased. The safe level is specified as a reverse-biased safe operating area (Figure 16). This rating is verified under clamped conditions so that the device is never subjected to an avalanche mode.

BUL146 BUL146F

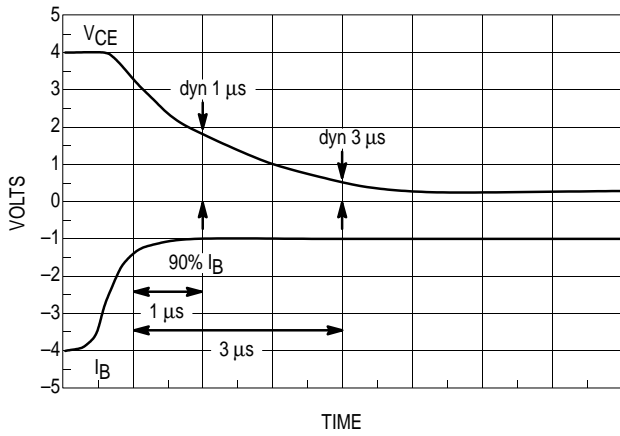

Figure 18. Dynamic Saturation Voltage Measurements

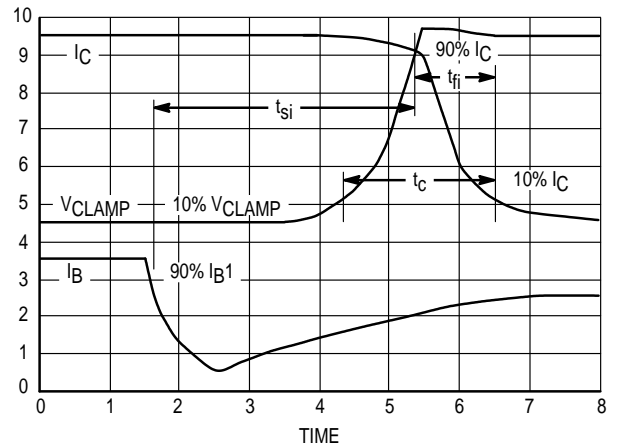
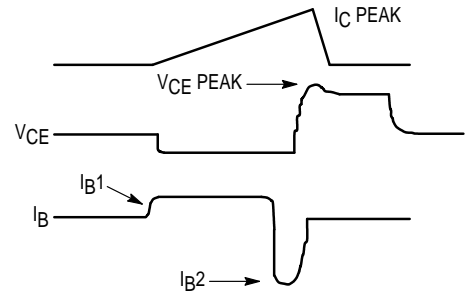
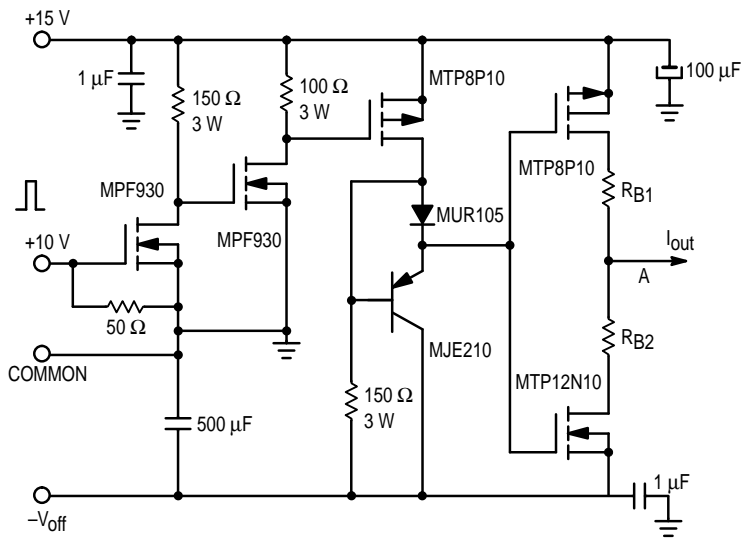

Figure 19. Inductive Switching Measurements



V(BR)CEO(sus)	INDUCTIVE SWITCHING	RBSOA
L = 10 mH	L = 200 μH	L = 500 μH
RB2 = ∞	RB2 = 0	RB2 = 0
V _{CC} = 20 VOLTS	V _{CC} = 15 VOLTS	V _{CC} = 15 VOLTS
I _{C(pk)} = 100 mA	RB1 SELECTED FOR DESIRED I _{B1}	RB1 SELECTED FOR DESIRED I _{B1}

Table 1. Inductive Load Switching Drive Circuit

TYPICAL THERMAL RESPONSE

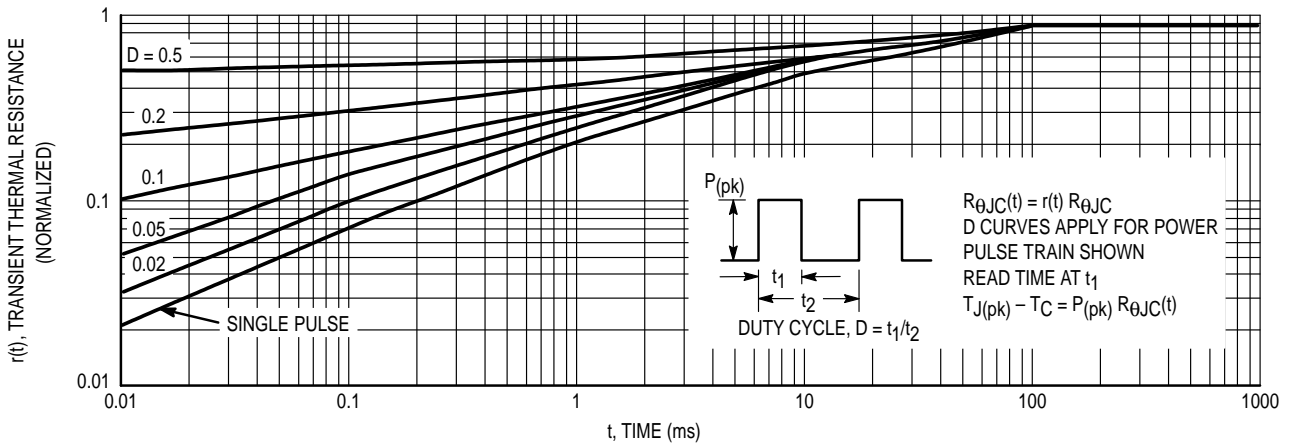

Figure 20. Typical Thermal Response ($Z_{\theta JC}(t)$) for BUL146

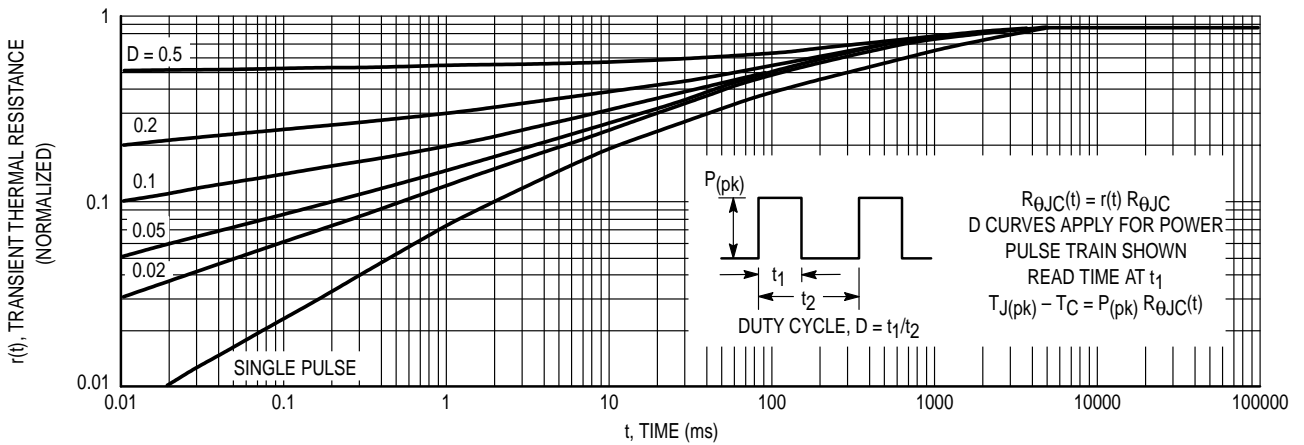
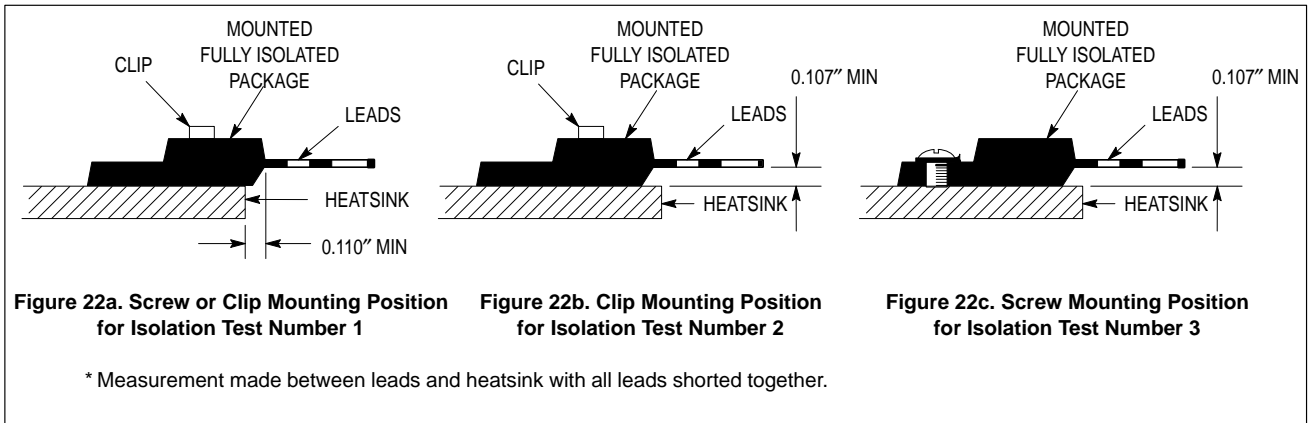
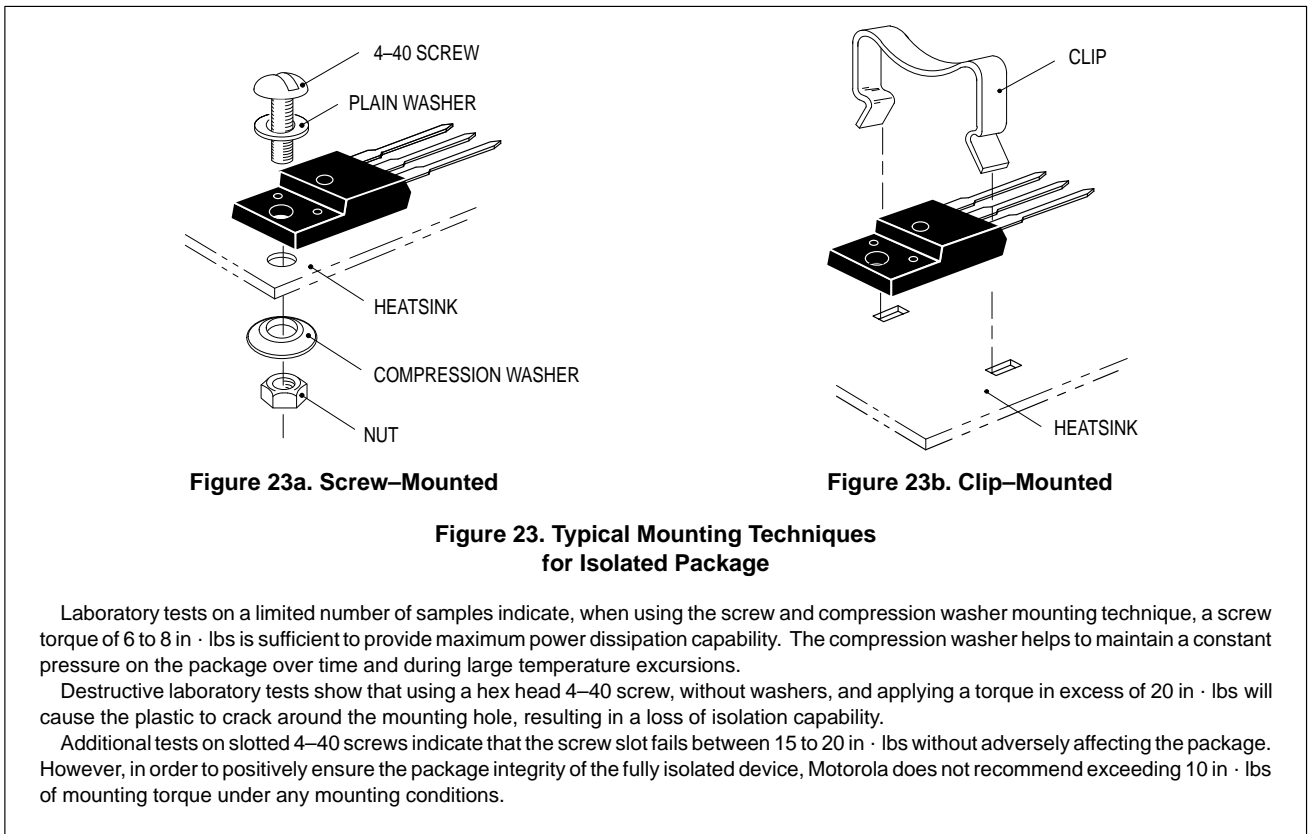

Figure 21. Typical Thermal Response ($Z_{\theta JC}(t)$) for BUL146F

TEST CONDITIONS FOR ISOLATION TESTS*



MOUNTING INFORMATION**



** For more information about mounting power semiconductors see Application Note AN1040.

PACKAGE DIMENSIONS

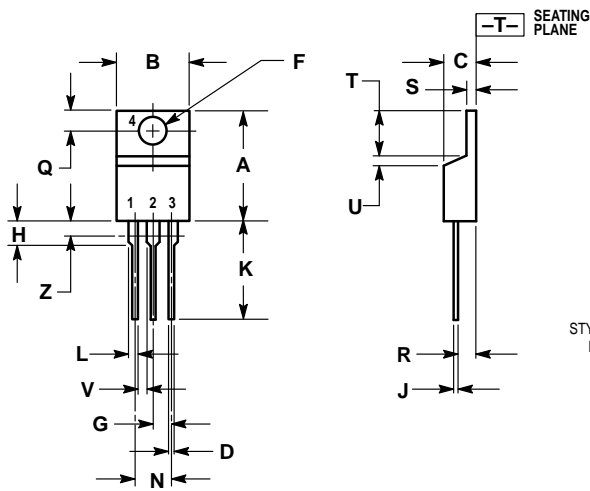

- NOTES:
1. DIMENSIONING AND TOLERANCING PER ANSI Y14.5M, 1982.
 2. CONTROLLING DIMENSION: INCH.
 3. DIMENSION Z DEFINES A ZONE WHERE ALL BODY AND LEAD IRREGULARITIES ARE ALLOWED.

DIM	INCHES		MILLIMETERS	
	MIN	MAX	MIN	MAX
A	0.570	0.620	14.48	15.75
B	0.380	0.405	9.66	10.28
C	0.160	0.190	4.07	4.82
D	0.025	0.035	0.64	0.88
F	0.142	0.147	3.61	3.73
G	0.095	0.105	2.42	2.66
H	0.110	0.155	2.80	3.93
J	0.018	0.025	0.46	0.64
K	0.500	0.562	12.70	14.27
L	0.045	0.060	1.15	1.52
N	0.190	0.210	4.83	5.33
Q	0.100	0.120	2.54	3.04
R	0.080	0.110	2.04	2.79
S	0.045	0.055	1.15	1.39
T	0.235	0.255	5.97	6.47
U	0.000	0.050	0.00	1.27
V	0.045	—	1.15	—
Z	—	0.080	—	2.04

- STYLE 1:
1. BASE
 2. COLLECTOR
 3. EMITTER
 4. COLLECTOR

BUL44
CASE 221A-06
TO-220AB
ISSUE Y

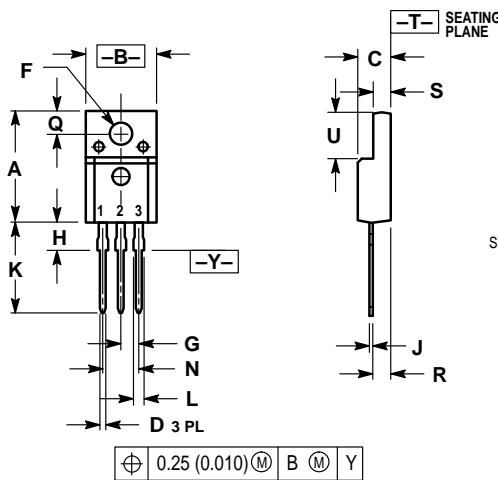

- NOTES:
1. DIMENSIONING AND TOLERANCING PER ANSI Y14.5M, 1982.
 2. CONTROLLING DIMENSION: INCH.

DIM	INCHES		MILLIMETERS	
	MIN	MAX	MIN	MAX
A	0.621	0.629	15.78	15.97
B	0.394	0.402	10.01	10.21
C	0.181	0.189	4.60	4.80
D	0.026	0.034	0.67	0.86
F	0.121	0.129	3.08	3.27
G	0.100 BSC	—	2.54 BSC	—
H	0.123	0.129	3.13	3.27
J	0.018	0.025	0.46	0.64
K	0.500	0.562	12.70	14.27
L	0.045	0.060	1.14	1.52
N	0.200 BSC	—	5.08 BSC	—
Q	0.126	0.134	3.21	3.40
R	0.107	0.111	2.72	2.81
S	0.096	0.104	2.44	2.64
U	0.259	0.267	6.58	6.78

- STYLE 2:
1. BASE
 2. COLLECTOR
 3. EMITTER

BUL44F
CASE 221D-02
(ISOLATED TO-220 TYPE)
ISSUE D

BUL146 BUL146F

Motorola reserves the right to make changes without further notice to any products herein. Motorola makes no warranty, representation or guarantee regarding the suitability of its products for any particular purpose, nor does Motorola assume any liability arising out of the application or use of any product or circuit, and specifically disclaims any and all liability, including without limitation consequential or incidental damages. "Typical" parameters can and do vary in different applications. All operating parameters, including "Typicals" must be validated for each customer application by customer's technical experts. Motorola does not convey any license under its patent rights nor the rights of others. Motorola products are not designed, intended, or authorized for use as components in systems intended for surgical implant into the body, or other applications intended to support or sustain life, or for any other application in which the failure of the Motorola product could create a situation where personal injury or death may occur. Should Buyer purchase or use Motorola products for any such unintended or unauthorized application, Buyer shall indemnify and hold Motorola and its officers, employees, subsidiaries, affiliates, and distributors harmless against all claims, costs, damages, and expenses, and reasonable attorney fees arising out of, directly or indirectly, any claim of personal injury or death associated with such unintended or unauthorized use, even if such claim alleges that Motorola was negligent regarding the design or manufacture of the part. Motorola and  are registered trademarks of Motorola, Inc. Motorola, Inc. is an Equal Opportunity/Affirmative Action Employer.

How to reach us:

USA / EUROPE: Motorola Literature Distribution;
P.O. Box 20912; Phoenix, Arizona 85036. 1-800-441-2447

JAPAN: Nippon Motorola Ltd.; Tatsumi-SPD-JLDC, Toshikatsu Otsuki,
6F Seibu-Butsuryu-Center, 3-14-2 Tatsumi Koto-Ku, Tokyo 135, Japan. 03-3521-8315

MFAX: RMFAX0@email.sps.mot.com - TOUCHTONE (602) 244-6609
INTERNET: <http://Design-NET.com>

HONG KONG: Motorola Semiconductors H.K. Ltd.; 8B Tai Ping Industrial Park,
51 Ting Kok Road, Tai Po, N.T., Hong Kong. 852-26629298



BUL146/D

