

Designer's™ Data Sheet
SWITCHMODE™ NPN Bipolar
Power Transistor for Electronic
Light Ballast and Switching
Power Supply Applications

The MJE/MJF18206 have an application specific state-of-the-art die dedicated to the electronic ballast ("light ballast") and power supply applications.

- Improved Global Efficiency Due to Low Base Drive Requirements:
 - High and Flat DC Current Gain h_{FE}
 - Fast Switching
 - No Coil Required in Base Circuit for fast Turn-Off (No Current Tail)
- Full Characterization at 125°C
- Motorola "6 SIGMA" Philosophy Provides Tight and Reproducible Parametric Distributions
- Two Package Choices: Standard TO-220 or Isolated TO-220

MAXIMUM RATINGS

Rating	Symbol	MJE18206	MJF18206	Unit
Collector-Emitter Voltage	V_{CEO}	600		Vdc
Collector-Base Voltage	V_{CBO}	1200		Vdc
Collector-Emitter Voltage	V_{CES}	1200		Vdc
Emitter-Base Voltage	V_{EBO}	10		Vdc
Collector Current — Continuous	I_C	8		Adc
— Peak (1)	I_{CM}	16		
Base Current — Continuous	I_B	5		Adc
— Peak (1)	I_{BM}	9		
RMS Isolation Voltage (2) (for 1 sec, R.H. ≤ 30%) $T_C = 25^\circ\text{C}$	Per Figure 22 Per Figure 23 Per Figure 24 V_{ISOL1} V_{ISOL2} V_{ISOL3}		4500 3500 1500	Volts
*Total Device Dissipation @ $T_C = 25^\circ\text{C}$ *Derate above 25°C	P_D	100 0.8	40 0.32	Watt W/°C
Operating and Storage Temperature	T_J, T_{stg}	-65 to 150		°C

THERMAL CHARACTERISTICS

Rating	Symbol	MJE18206	MJF18206	Unit
Thermal Resistance — Junction to Case	$R_{\theta JC}$	1.25	3.125	°C/W
— Junction to Ambient	$R_{\theta JA}$	62.5	62.5	
Maximum Lead Temperature for Soldering Purposes: 1/8" from Case for 5 Seconds	T_L	260		°C

- (1) Pulse Test: Pulse Width = 5 ms, Duty Cycle ≤ 10%.
(2) Proper strike and creepage distance must be provided.

Designer's Data for "Worst Case" Conditions — The Designer's Data Sheet permits the design of most circuits entirely from the information presented. SOA Limit curves — representing boundaries on device characteristics — are given to facilitate "worst case" design.

Designer's and SWITCHMODE are trademarks of Motorola, Inc.

MJE18206
MJF18206

POWER TRANSISTORS
8 AMPERES
1200 VOLTS
40 and 100 WATTS

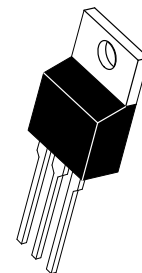
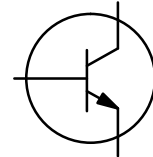

CASE 221A-06
TO-220AB

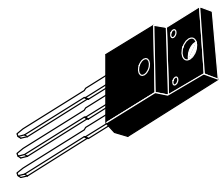

CASE 221D-02
TO-220 FULLPACK

MJE18206 MJF18206

ELECTRICAL CHARACTERISTICS ($T_C = 25^\circ\text{C}$ unless otherwise noted)

Characteristic	Symbol	Min	Typ	Max	Unit
OFF CHARACTERISTICS					
Collector–Emitter Sustaining Voltage ($I_C = 100\text{ mA}$, $L = 25\text{ mH}$) ($I_C = 200\text{ mA}$, $L = 25\text{ mH}$, $R = 200\ \Omega$)	$V_{CEO(sus)}$ $V_{CER(sus)}$	550 600	630 700		Vdc
Collector–Base Breakdown Voltage ($I_{CBO} = 1\text{ mA}$, $I_E = 0$)	V_{CBO}	1200	1320		Vdc
Emitter–Base Breakdown Voltage ($I_{EBO} = 1\text{ mA}$, $I_C = 0$)	V_{EBO}	10	12.9		Vdc
Collector Cutoff Current ($V_{CE} = 550\text{ V}$, $I_B = 0$) ($V_{CE} = 550\text{ V}$, $I_B = 0$)	@ $T_C = 25^\circ\text{C}$ @ $T_C = 125^\circ\text{C}$ I_{CEO}			200 2000	μAdc
Collector Cutoff Current ($V_{CE} = \text{Rated } V_{CES}$, $V_{BE} = 0$) ($V_{CE} = 1000\text{ V}$, $V_{BE} = 0$)	@ $T_C = 25^\circ\text{C}$ @ $T_C = 125^\circ\text{C}$ @ $T_C = 125^\circ\text{C}$ I_{CES}			100 1000 100	μAdc
Collector Cutoff Current ($V_{CB} = 1200\text{ V}$, $I_E = 0$)	I_{CBO}			100	μAdc
Emitter–Cutoff Current ($V_{EB} = 9\text{ Vdc}$, $I_C = 0$)	I_{EBO}			100	μAdc

ON CHARACTERISTICS

Base–Emitter Saturation Voltage ($I_C = 1.3\text{ Adc}$, $I_B = 0.13\text{ Adc}$) ($I_C = 2\text{ Adc}$, $I_B = 0.4\text{ Adc}$) ($I_C = 3\text{ Adc}$, $I_B = 0.6\text{ Adc}$)	@ $T_C = 25^\circ\text{C}$ @ $T_C = 125^\circ\text{C}$ @ $T_C = 25^\circ\text{C}$ @ $T_C = 125^\circ\text{C}$ @ $T_C = 25^\circ\text{C}$ @ $T_C = 125^\circ\text{C}$	$V_{BE(sat)}$		0.77 0.67 0.85 0.75 0.91 0.8	1 0.9 1.1 1 1.1 1	Vdc
Collector–Emitter Saturation Voltage ($I_C = 1.3\text{ Adc}$, $I_B = 0.13\text{ Adc}$) ($I_C = 3\text{ Adc}$, $I_B = 0.6\text{ Adc}$)	@ $T_C = 25^\circ\text{C}$ @ $T_C = 125^\circ\text{C}$ @ $T_C = 25^\circ\text{C}$ @ $T_C = 125^\circ\text{C}$	$V_{CE(sat)}$		0.3 0.4 0.4 0.8	0.75 1 0.75 1.25	Vdc
DC Current Gain ($I_C = 0.5\text{ Adc}$, $V_{CE} = 5\text{ Vdc}$) ($I_C = 1\text{ Adc}$, $V_{CE} = 5\text{ Vdc}$) ($I_C = 3\text{ Adc}$, $V_{CE} = 1\text{ Vdc}$) ($I_C = 10\text{ mAdc}$, $V_{CE} = 5\text{ Vdc}$)	@ $T_C = 25^\circ\text{C}$ @ $T_C = 125^\circ\text{C}$ @ $T_C = 25^\circ\text{C}$ @ $T_C = 125^\circ\text{C}$ @ $T_C = 25^\circ\text{C}$ @ $T_C = 125^\circ\text{C}$ @ $T_C = 25^\circ\text{C}$ @ $T_C = 125^\circ\text{C}$	h_{FE}	18 18 5 4 11	25 25 20 8 6 33	— 45 — 50	—

DYNAMIC CHARACTERISTICS

Current Gain Bandwidth ($I_C = 0.5\text{ Adc}$, $V_{CE} = 10\text{ Vdc}$, $f = 1\text{ MHz}$)	f_T		13		MHz
Output Capacitance ($V_{CB} = 10\text{ Vdc}$, $I_E = 0$, $f = 1\text{ MHz}$)	C_{ob}			200	pF
Input Capacitance ($V_{EB} = 8\text{ Vdc}$)	C_{ib}			2000	pF

DYNAMIC SATURATION VOLTAGE

Dynamic Saturation Voltage: Determined 1 μs and 3 μs respectively after rising I_{B1} reaches 90% of final I_{B1}	$I_C = 1.3\text{ Adc}$ $I_{B1} = 130\text{ mAdc}$ $V_{CC} = 300\text{ V}$	@ 1 μs	@ $T_C = 25^\circ\text{C}$	$V_{CE(dsat)}$	7.5	V
		@ 3 μs	@ $T_C = 25^\circ\text{C}$		4.5	
	$I_C = 3\text{ Adc}$ $I_{B1} = 0.6\text{ Adc}$ $V_{CC} = 300\text{ V}$	@ 1 μs	@ $T_C = 25^\circ\text{C}$		14.5	
		@ 3 μs	@ $T_C = 25^\circ\text{C}$		6	

ELECTRICAL CHARACTERISTICS ($T_C = 25^\circ\text{C}$ unless otherwise noted)

Characteristic		Symbol	Min	Typ	Max	Unit		
SWITCHING CHARACTERISTICS: Resistive Load (D.C. $\leq 10\%$, Pulse Width = 40 μs)								
Turn-on Time	$I_C = 3 \text{ Adc}$, $I_{B1} = 0.6 \text{ Adc}$ $I_{B2} = 1.5 \text{ Adc}$ $V_{CC} = 300 \text{ Vdc}$	@ $T_C = 25^\circ\text{C}$	t_{on}		200	350	ns	
Turn-off Time		@ $T_C = 25^\circ\text{C}$ @ $T_C = 125^\circ\text{C}$	t_{off}		2 2.5	2.5	μs	
Turn-on Time	$I_C = 3 \text{ Adc}$, $I_{B1} = 0.6 \text{ Adc}$ $I_{B2} = 0.6 \text{ Adc}$ $V_{CC} = 300 \text{ Vdc}$	@ $T_C = 25^\circ\text{C}$	t_{on}		190	250	ns	
Turn-off Time		@ $T_C = 25^\circ\text{C}$ @ $T_C = 125^\circ\text{C}$	t_{off}		3.7 4.5	4.5	μs	
Turn-on Time	$I_C = 1 \text{ Adc}$, $I_{B1} = 70 \text{ mAdc}$ $I_{B2} = 1 \text{ Adc}$ $V_{CC} = 125 \text{ Vdc}$ PW = 70 μs	@ $T_C = 25^\circ\text{C}$	t_d		125	300	ns	
				t_r		400	750	ns
Turn-off Time		@ $T_C = 25^\circ\text{C}$	t_s		600	1.2	μs	
				t_f		450	700	ns
Turn-on Time	$I_C = 1 \text{ Adc}$, $I_{B1} = 100 \text{ mAdc}$ $I_{B2} = 500 \text{ mAdc}$ $V_{CC} = 300 \text{ Vdc}$	@ $T_C = 25^\circ\text{C}$ @ $T_C = 125^\circ\text{C}$	t_{on}		250 225	350	ns	
Turn-off Time		@ $T_C = 25^\circ\text{C}$ @ $T_C = 125^\circ\text{C}$	t_{off}		2 2.5	2.75	μs	

SWITCHING CHARACTERISTICS: Inductive Load ($V_{clamp} = 300 \text{ V}$, $V_{CC} = 15 \text{ V}$, $L = 200 \mu\text{H}$)

Fall Time	$I_C = 1.3 \text{ Adc}$ $I_{B1} = 0.13 \text{ Adc}$ $I_{B2} = 0.65 \text{ Adc}$	@ $T_C = 25^\circ\text{C}$ @ $T_C = 125^\circ\text{C}$	t_f		150 225	200	ns
Storage Time		@ $T_C = 25^\circ\text{C}$ @ $T_C = 125^\circ\text{C}$	t_s		1.6 1.9	2	μs
Crossover Time		@ $T_C = 25^\circ\text{C}$ @ $T_C = 125^\circ\text{C}$	t_c		260 300	350	ns
Fall Time	$I_C = 3 \text{ Adc}$ $I_{B1} = 0.6 \text{ Adc}$ $I_{B2} = 1.5 \text{ Adc}$	@ $T_C = 25^\circ\text{C}$ @ $T_C = 125^\circ\text{C}$	t_f		300 400	450	ns
Storage Time		@ $T_C = 25^\circ\text{C}$ @ $T_C = 125^\circ\text{C}$	t_s		2.25 2.5	2.75	μs
Crossover Time		@ $T_C = 25^\circ\text{C}$ @ $T_C = 125^\circ\text{C}$	t_c		500 700	800	ns
Fall Time	$I_C = 3 \text{ Adc}$ $I_{B1} = 0.6 \text{ Adc}$ $I_{B2} = 0.6 \text{ Adc}$	@ $T_C = 25^\circ\text{C}$ @ $T_C = 125^\circ\text{C}$	t_f		350 500	500	ns
Storage Time		@ $T_C = 25^\circ\text{C}$ @ $T_C = 125^\circ\text{C}$	t_s		4.25 5.1	5	μs
Crossover Time		@ $T_C = 25^\circ\text{C}$ @ $T_C = 125^\circ\text{C}$	t_c		600 1100	800	ns

TYPICAL STATIC CHARACTERISTICS

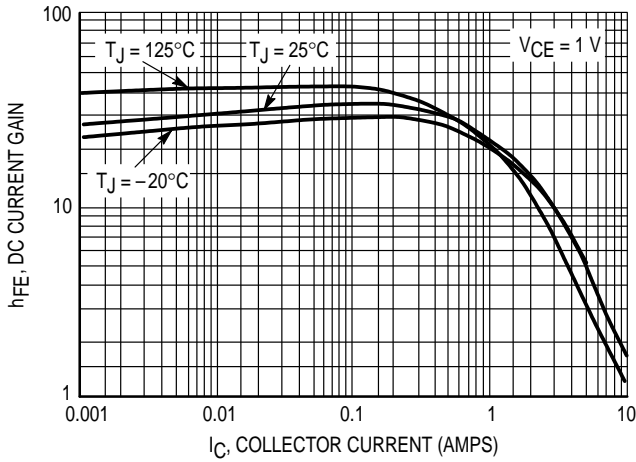

Figure 1. DC Current Gain @ 1 Volt

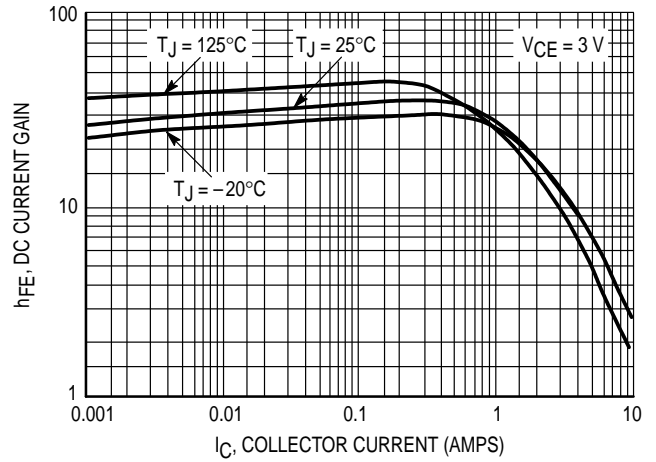

Figure 2. DC Current Gain @ 3 Volts

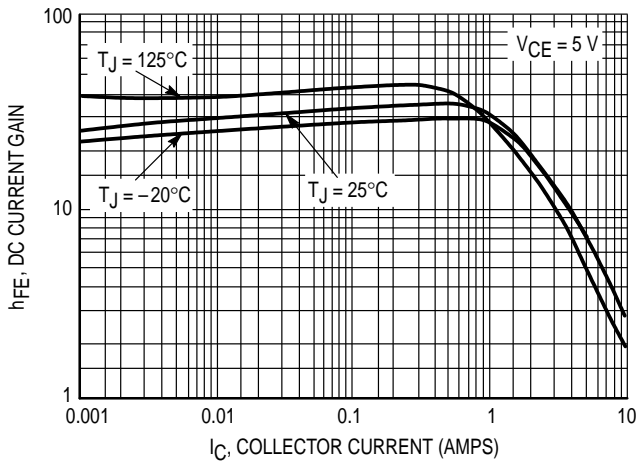

Figure 3. DC Current Gain @ 5 Volts

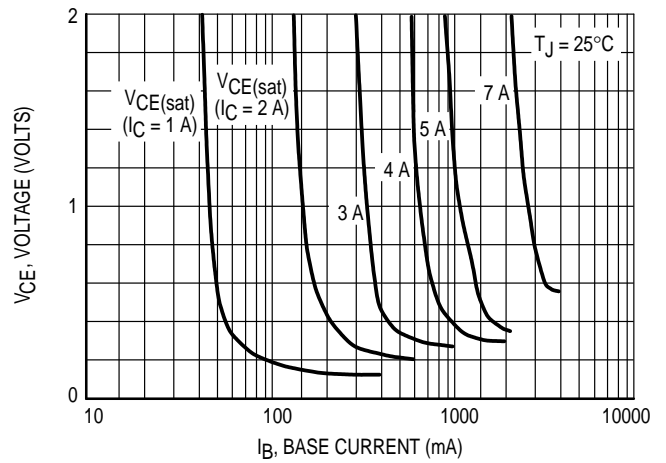

Figure 4. Collector Saturation Region

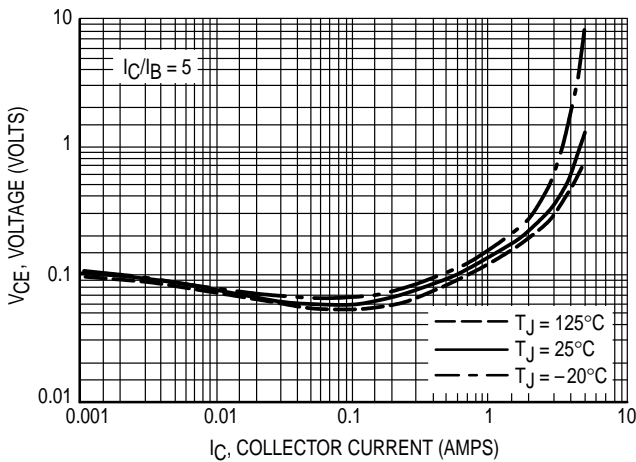

Figure 5A. Collector-Emmitter Saturation Voltage

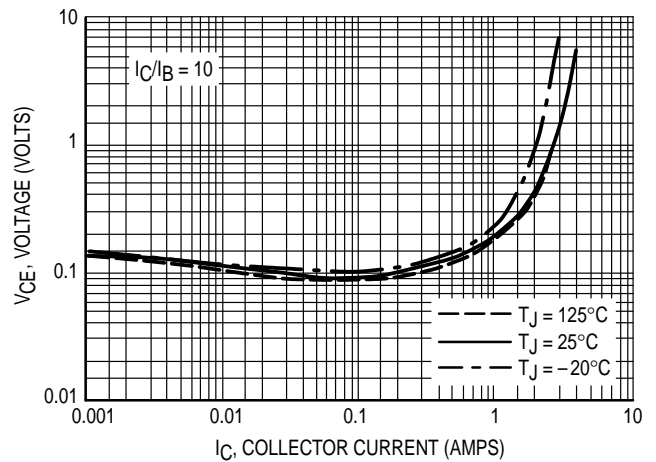

Figure 5B. Collector-Emmitter Saturation Voltage

TYPICAL STATIC CHARACTERISTICS

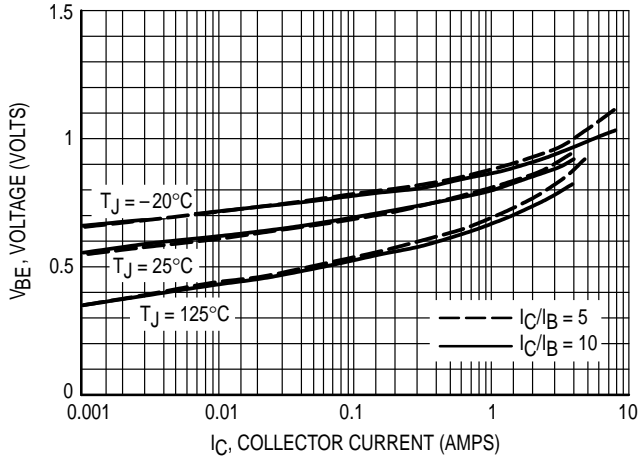

Figure 6. Base-Emitter Saturation Region

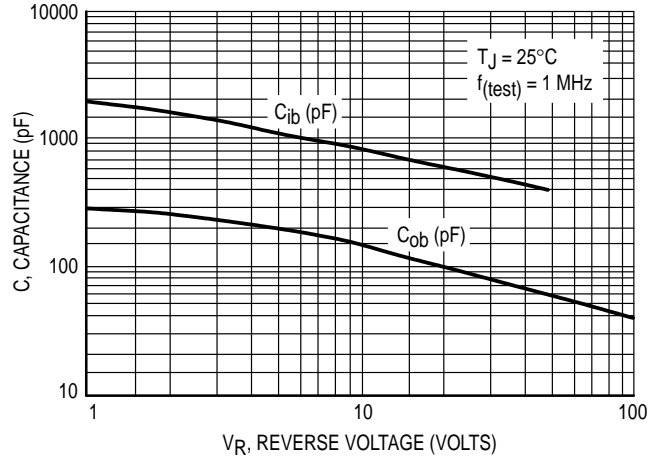

Figure 7. Capacitance

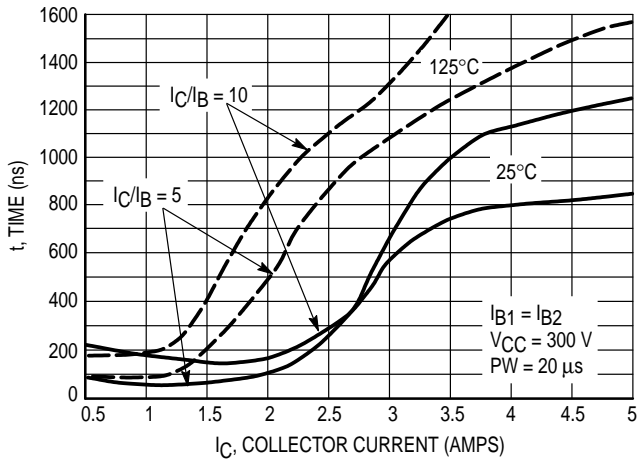

Figure 8. Resistive Switching, t_{on}

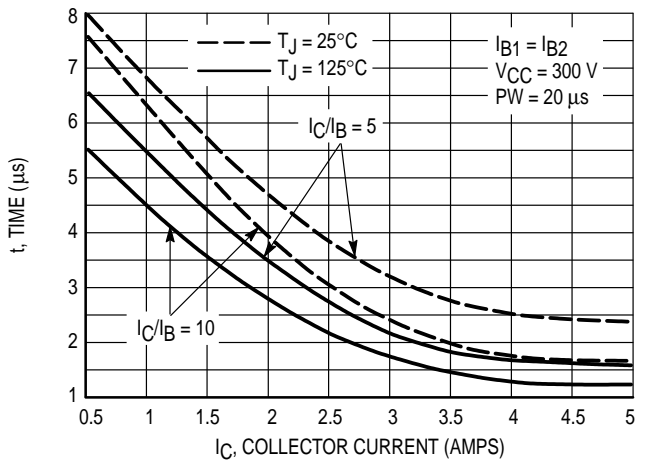

Figure 9. Resistive Switching, t_{off}

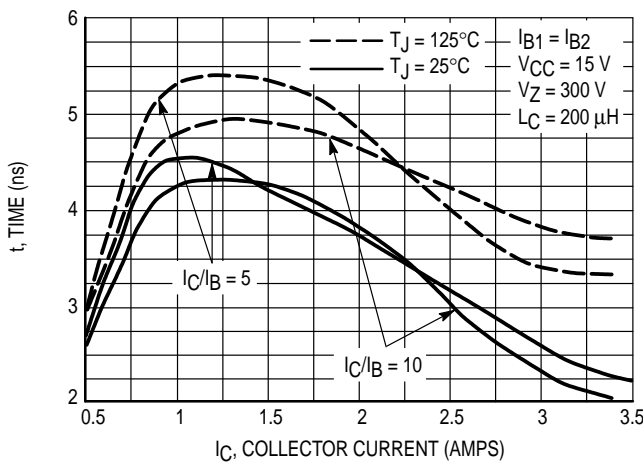

Figure 10. Inductive Storage Time, t_{si}

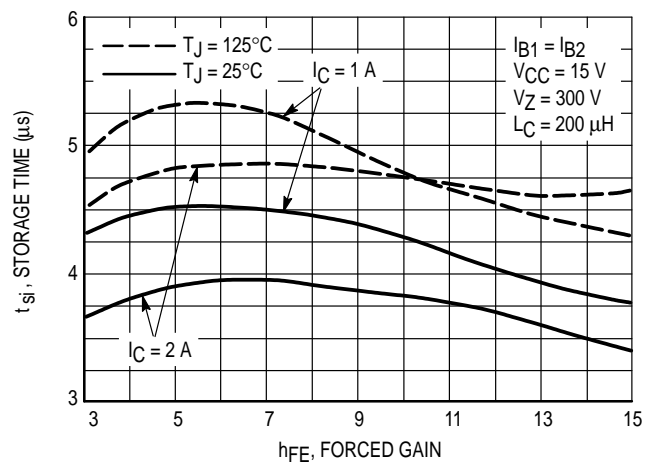

Figure 11. Inductive Storage Time

TYPICAL STATIC CHARACTERISTICS

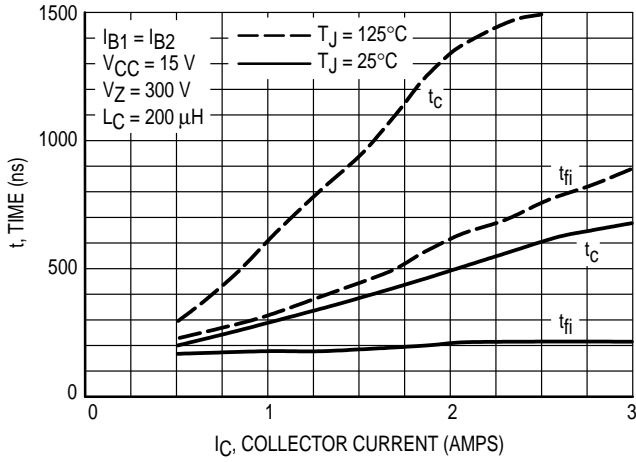

Figure 12. Inductive Switching, t_c & t_{fi} @ $I_C/I_B = 5$

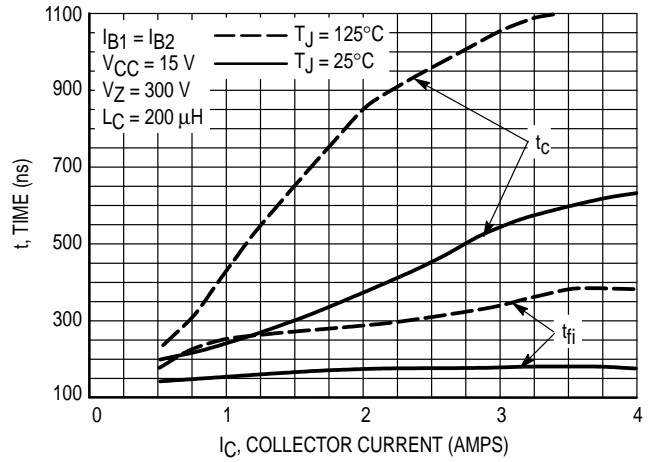

Figure 13. Inductive Switching, t_c & t_{fi} @ $I_C/I_B = 10$

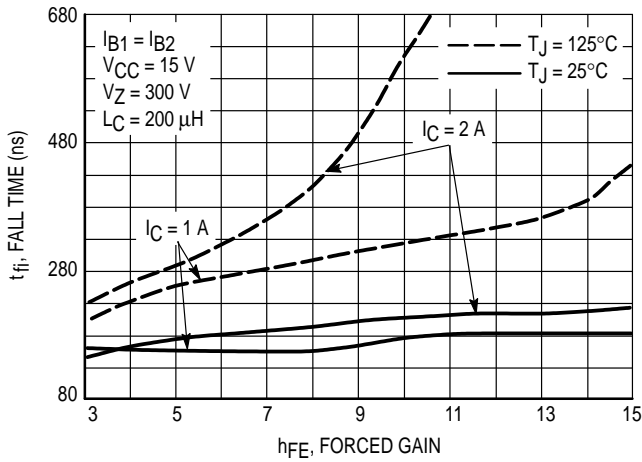

Figure 14. Inductive Fall Time

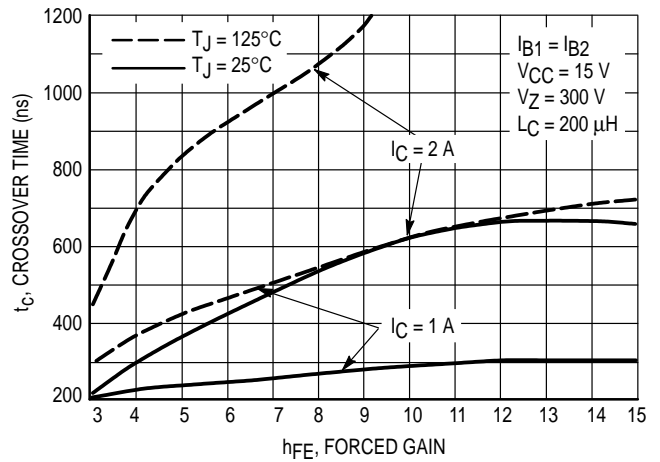

Figure 15. Inductive Crossover Time

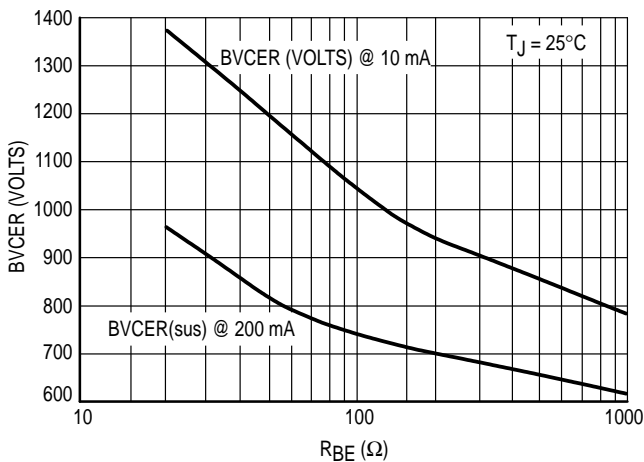

Figure 16. $BV_{CEr} = f(R_{BE})$

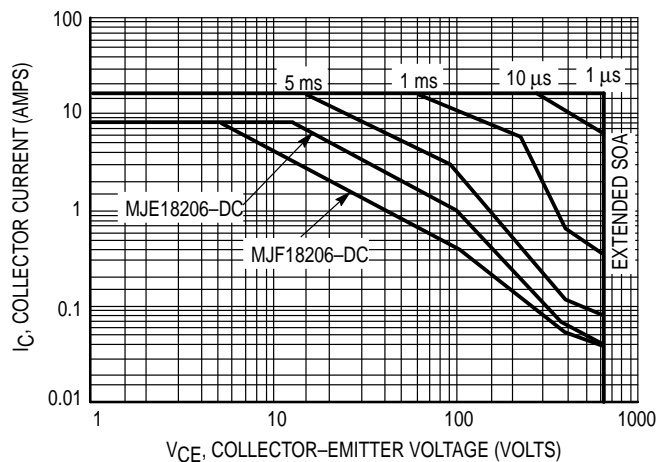

Figure 17. Forward Bias Safe Operating Area

TYPICAL STATIC CHARACTERISTICS

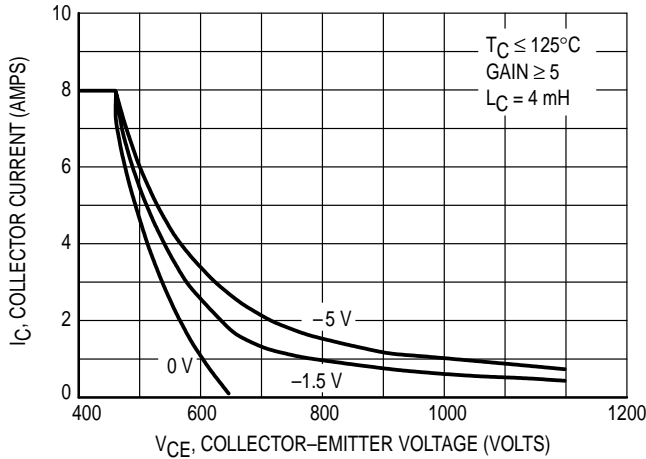

Figure 18. Reverse Bias Switching Safe Operating Area

There are two limitations on the power handling ability of a transistor: average junction temperature and second breakdown. Safe operating area curves indicate I_C - V_{CE} limits of the transistor that must be observed for reliable operation; i.e., the transistor must not be subjected to greater dissipation than the curves indicate. The data of Figure 17 is based on $T_C = 25^\circ\text{C}$; $T_J(\text{pk})$ is variable depending on power level. Second breakdown pulse limits are valid for duty cycles to 10% but must be derated when $T_C > 25^\circ\text{C}$. Second breakdown limitations do not derate the same as thermal limitations. Allowable current at the voltages shown on Figure 17 may be found at any case temperature by using

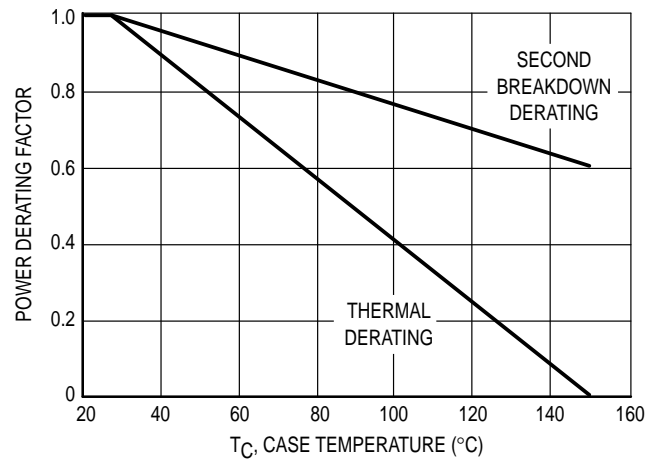

Figure 19. Forward Bias Power Derating

the appropriate curve on Figure 19.

$T_J(\text{pk})$ may be calculated from the data in Figures 22 and 23. At any case temperatures, thermal limitations will reduce the power that can be handled to values less than the limitations imposed by second breakdown. For inductive loads, high voltage and current must be sustained simultaneously during turn-off with the base-to-emitter junction reverse biased. The safe level is specified as a reverse-biased safe operating area (Figure 18). This rating is verified under clamped conditions so that the device is never subjected to an avalanche mode.

TYPICAL SWITCHING CHARACTERISTICS
($I_{B1} = I_{B2}$ FOR ALL CURVES)

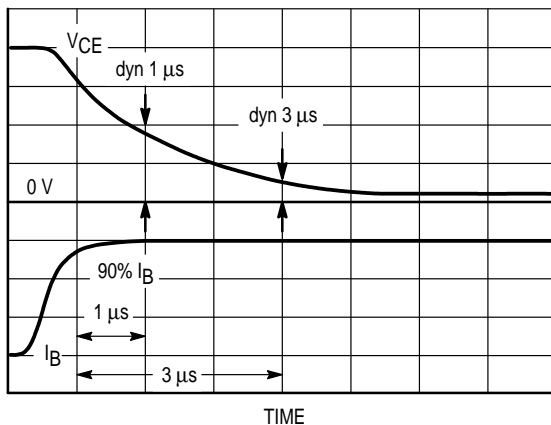

Figure 20. Dynamic Saturation Voltage Measurements

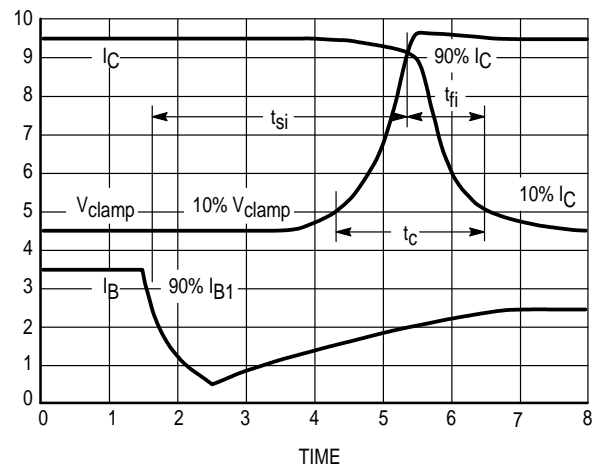
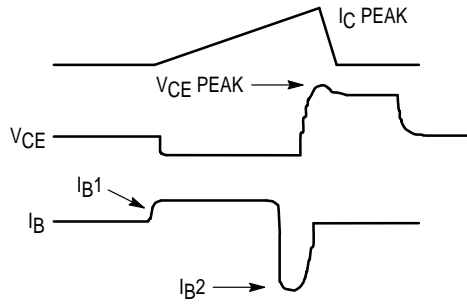
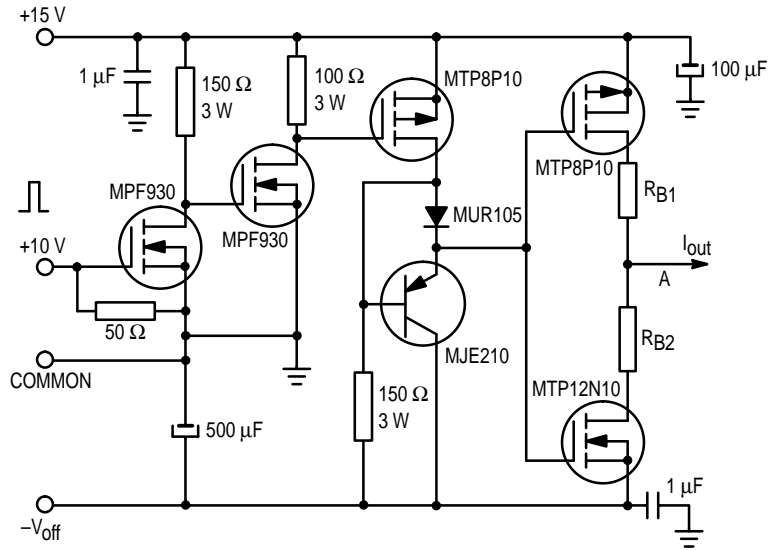

Figure 21. Inductive Switching Measurements

TYPICAL SWITCHING CHARACTERISTICS
($I_{B1} = I_{B2}$ FOR ALL CURVES)

Table 1. Inductive Load Switching Drive Circuit



$V_{(BR)CEO(sus)}$
 $L = 10 \text{ mH}$
 $R_{B2} = \infty$
 $V_{CC} = 20 \text{ Volts}$
 $I_{C(pk)} = 100 \text{ mA}$

Inductive Switching
 $L = 200 \mu\text{H}$
 $R_{B2} = 0$
 $V_{CC} = 15 \text{ Volts}$
 R_{B1} selected for desired I_{B1}

RBSOA
 $L = 500 \mu\text{H}$
 $R_{B2} = 0$
 $V_{CC} = 15 \text{ Volts}$
 R_{B1} selected for desired I_{B1}

TYPICAL THERMAL RESPONSE
($I_{B1} = I_{B2}$ FOR ALL CURVES)

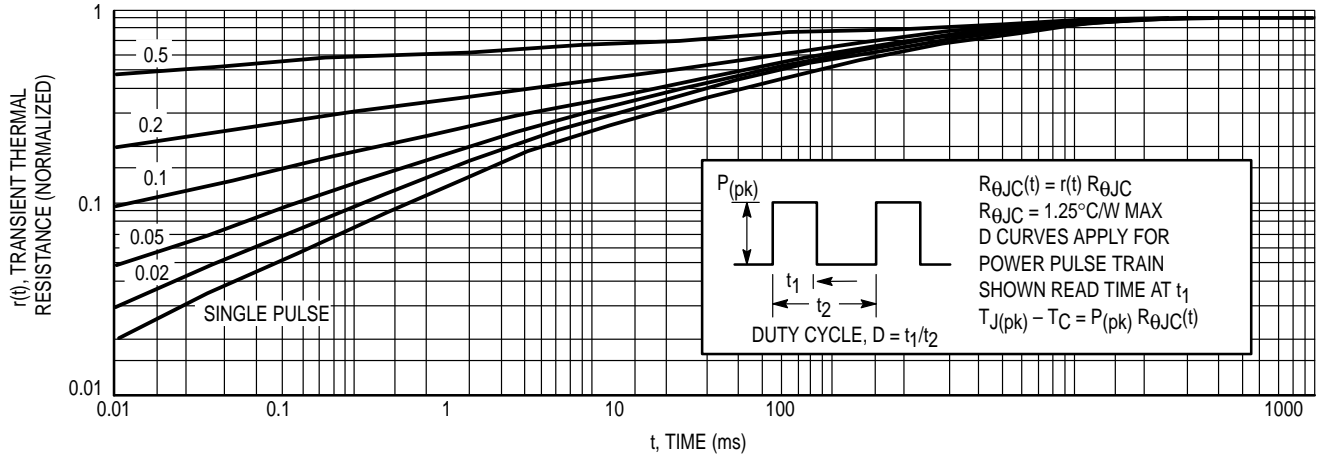

Figure 22. Typical Thermal Response ($Z_{\theta JC}(t)$) for MJE18206

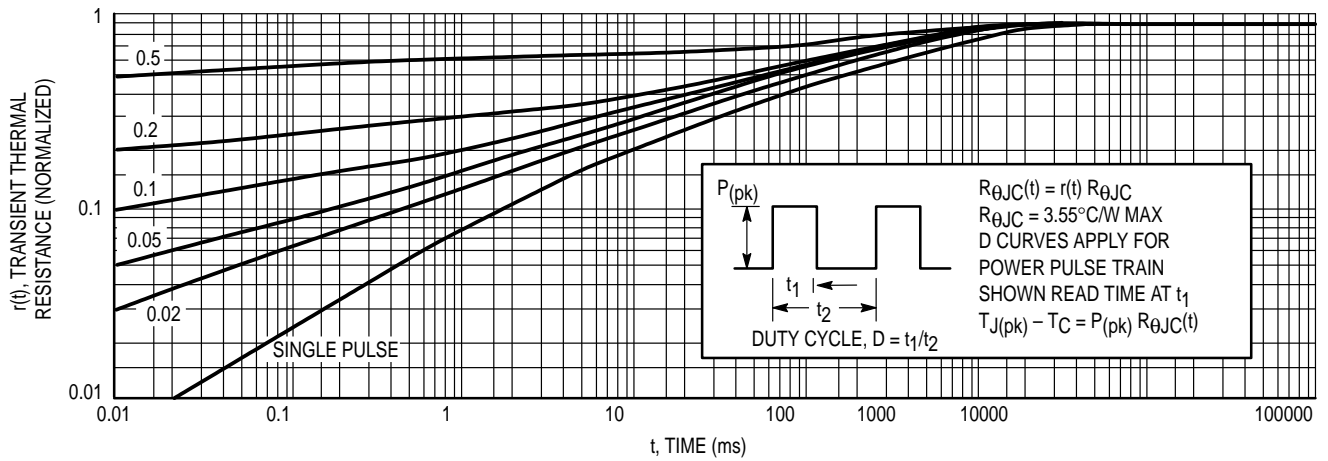
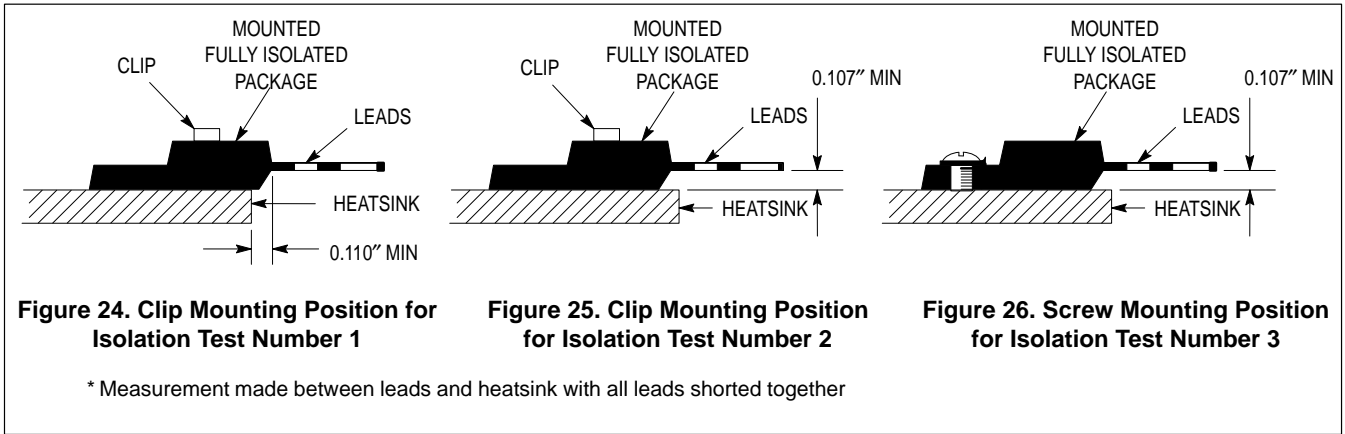
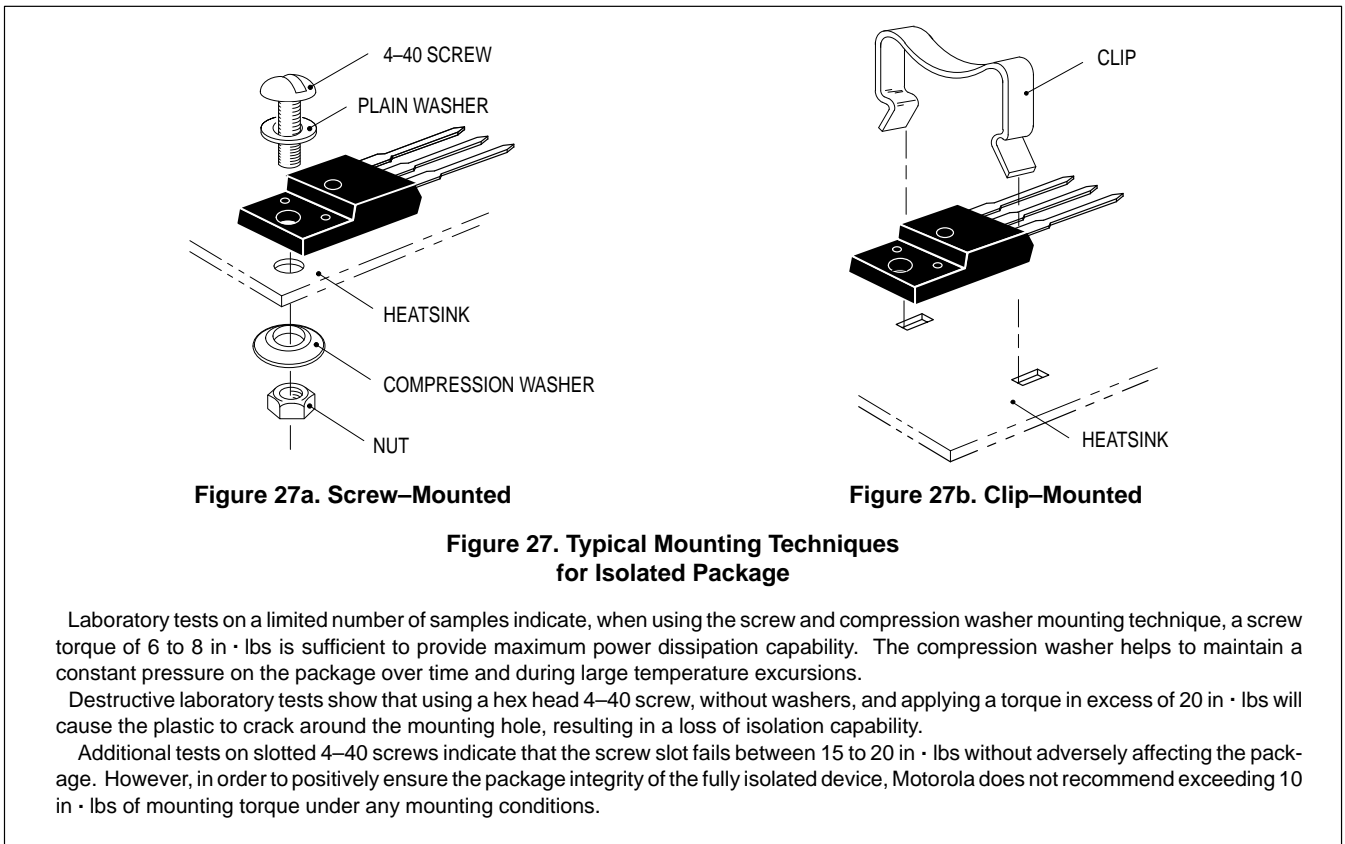

Figure 23. Typical Thermal Response ($Z_{\theta JC}(t)$) for MJF18206

TEST CONDITIONS FOR ISOLATION TESTS*



MOUNTING INFORMATION**



** For more information about mounting power semiconductors see Application Note AN1040.

PACKAGE DIMENSIONS

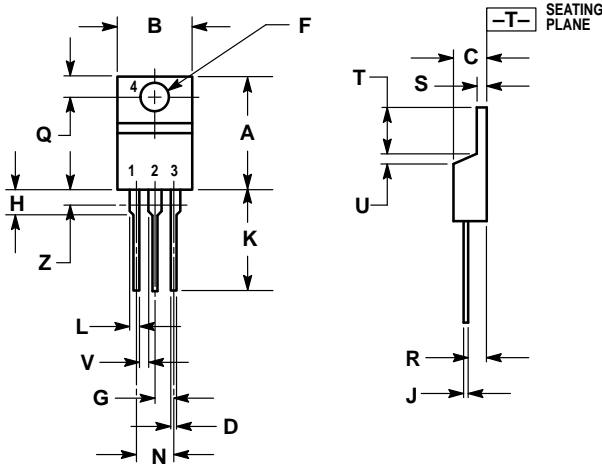

- NOTES:
1. DIMENSIONING AND TOLERANCING PER ANSI Y14.5M, 1982.
 2. CONTROLLING DIMENSION: INCH.
 3. DIMENSION Z DEFINES A ZONE WHERE ALL BODY AND LEAD IRREGULARITIES ARE ALLOWED.

DIM	INCHES		MILLIMETERS	
	MIN	MAX	MIN	MAX
A	0.570	0.620	14.48	15.75
B	0.380	0.405	9.66	10.28
C	0.160	0.190	4.07	4.82
D	0.025	0.035	0.64	0.88
F	0.142	0.147	3.61	3.73
G	0.095	0.105	2.42	2.66
H	0.110	0.155	2.80	3.93
J	0.018	0.025	0.46	0.64
K	0.500	0.562	12.70	14.27
L	0.045	0.060	1.15	1.52
N	0.190	0.210	4.83	5.33
Q	0.100	0.120	2.54	3.04
R	0.080	0.110	2.04	2.79
S	0.045	0.055	1.15	1.39
T	0.235	0.255	5.97	6.47
U	0.000	0.050	0.00	1.27
V	0.045	—	1.15	—
Z	—	0.080	—	2.04

- STYLE 1:
 PIN 1. BASE
 2. COLLECTOR
 3. EMITTER
 4. COLLECTOR

CASE 221A-06
 TO-220AB
 ISSUE Y

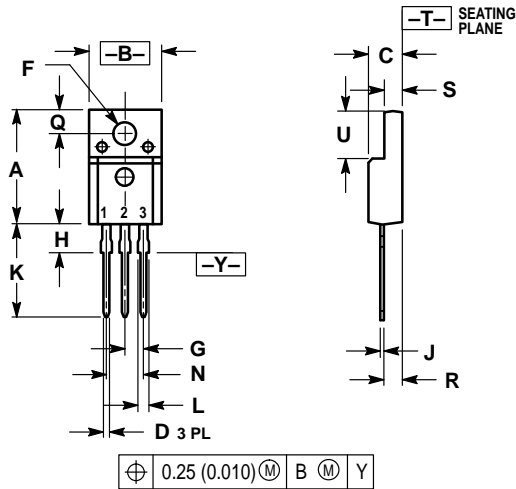

- NOTES:
1. DIMENSIONING AND TOLERANCING PER ANSI Y14.5M, 1982.
 2. CONTROLLING DIMENSION: INCH.

DIM	INCHES		MILLIMETERS	
	MIN	MAX	MIN	MAX
A	0.621	0.629	15.78	15.97
B	0.394	0.402	10.01	10.21
C	0.181	0.189	4.60	4.80
D	0.026	0.034	0.67	0.86
F	0.121	0.129	3.08	3.27
G	0.100 BSC	—	2.54 BSC	—
H	0.123	0.129	3.13	3.27
J	0.018	0.025	0.46	0.64
K	0.500	0.562	12.70	14.27
L	0.045	0.060	1.14	1.52
N	0.200 BSC	—	5.08 BSC	—
Q	0.126	0.134	3.21	3.40
R	0.107	0.111	2.72	2.81
S	0.096	0.104	2.44	2.64
U	0.259	0.267	6.58	6.78

- STYLE 1:
 PIN 1. GATE
 2. DRAIN
 3. SOURCE

CASE 221D-02
 (ISOLATED TO-220 TYPE)
 UL RECOGNIZED: FILE #E69369
 ISSUE D

Motorola reserves the right to make changes without further notice to any products herein. Motorola makes no warranty, representation or guarantee regarding the suitability of its products for any particular purpose, nor does Motorola assume any liability arising out of the application or use of any product or circuit, and specifically disclaims any and all liability, including without limitation consequential or incidental damages. "Typical" parameters can and do vary in different applications. All operating parameters, including "Typicals" must be validated for each customer application by customer's technical experts. Motorola does not convey any license under its patent rights nor the rights of others. Motorola products are not designed, intended, or authorized for use as components in systems intended for surgical implant into the body, or other applications intended to support or sustain life, or for any other application in which the failure of the Motorola product could create a situation where personal injury or death may occur. Should Buyer purchase or use Motorola products for any such unintended or unauthorized application, Buyer shall indemnify and hold Motorola and its officers, employees, subsidiaries, affiliates, and distributors harmless against all claims, costs, damages, and expenses, and reasonable attorney fees arising out of, directly or indirectly, any claim of personal injury or death associated with such unintended or unauthorized use, even if such claim alleges that Motorola was negligent regarding the design or manufacture of the part. Motorola and  are registered trademarks of Motorola, Inc. Motorola, Inc. is an Equal Opportunity/Affirmative Action Employer.

How to reach us:

USA / EUROPE: Motorola Literature Distribution;
P.O. Box 20912; Phoenix, Arizona 85036. 1-800-441-2447

JAPAN: Nippon Motorola Ltd.; Tatsumi-SPD-JLDC, Toshikatsu Otsuki,
6F Seibu-Butsuryu-Center, 3-14-2 Tatsumi Koto-Ku, Tokyo 135, Japan. 03-3521-8315

MFAX: RMFAX0@email.sps.mot.com – TOUCHTONE (602) 244-6609
INTERNET: <http://Design-NET.com>

HONG KONG: Motorola Semiconductors H.K. Ltd.; 8B Tai Ping Industrial Park,
51 Ting Kok Road, Tai Po, N.T., Hong Kong. 852-26629298

