

Schottky Barrier Diodes

Schottky barrier diodes are designed primarily for high-efficiency UHF and VHF detector applications. Readily available to many other fast switching RF and digital applications. They are housed in the SOT-323/SC-70 package which is designed for low-power surface mount applications.

- Extremely Low Minority Carrier Lifetime
- Very Low Capacitance
- Low Reverse Leakage
- Available in 8 mm Tape and Reel

MMBD110T1
MMBD330T1
MMBD770T1

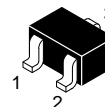

CASE 419A-02, STYLE 2
SOT-323/SC-70

MAXIMUM RATINGS

Rating	Symbol	Value	Unit
Reverse Voltage MMBD110T1 MMBD330T1 MMBD770T1	V_R	7.0 30 70	Vdc
Forward Power Dissipation $T_A = 25^\circ\text{C}$	P_F	120	mW
Junction Temperature	T_J	-55 to +125	$^\circ\text{C}$
Storage Temperature Range	T_{stg}	-55 to +150	$^\circ\text{C}$

DEVICE MARKING

MMBD110T1 = 4M
MMBD330T1 = 4T
MMBD770T1 = 5H

Thermal Clad is a registered trademark of the Bergquist Company.

MMBD110T1 MMBD330T1 MMBD770T1
ELECTRICAL CHARACTERISTICS ($T_A = 25^\circ\text{C}$ unless otherwise noted)

Characteristic		Symbol	Min	Typ	Max	Unit
Reverse Breakdown Voltage ($I_R = 10 \mu\text{A}$)	MMBD110T1 MMBD330T1 MMBD770T1	$V_{(BR)R}$	7.0 30 70	10 — —	— — —	Volts
Diode Capacitance ($V_R = 0$, $f = 1.0 \text{ MHz}$, Note 1) ($V_R = 15 \text{ Volts}$, $f = 1.0 \text{ MHz}$) ($V_R = 20 \text{ Volts}$, $f = 1.0 \text{ MHz}$)	MMBD110T1 MMBD330T1 MMBD770T1	C_T	— — —	0.88 0.9 0.5	1.0 1.5 1.0	pF
Reverse Leakage ($V_R = 3.0 \text{ V}$) ($V_R = 25 \text{ V}$) ($V_R = 35 \text{ V}$)	MMBD110T1 MMBD330T1 MMBD770T1	I_R	— — —	20 13 9.0	250 200 200	nAdc
Noise Figure ($f = 1.0 \text{ GHz}$, Note 2)	MMBD110T1	NF	—	6.0	—	dB
Forward Voltage ($I_F = 10 \text{ mA}$) ($I_F = 1.0 \text{ mAdc}$) ($I_F = 10 \text{ mA}$) ($I_F = 1.0 \text{ mAdc}$) ($I_F = 10 \text{ mA}$)	MMBD110T1 MMBD330T1 MMBD770T1 MMBD770T1	V_F	— — — — —	0.5 0.38 0.52 0.42 0.7	0.6 0.45 0.6 0.5 1.0	Vdc

TYPICAL CHARACTERISTICS
MMBD110T1

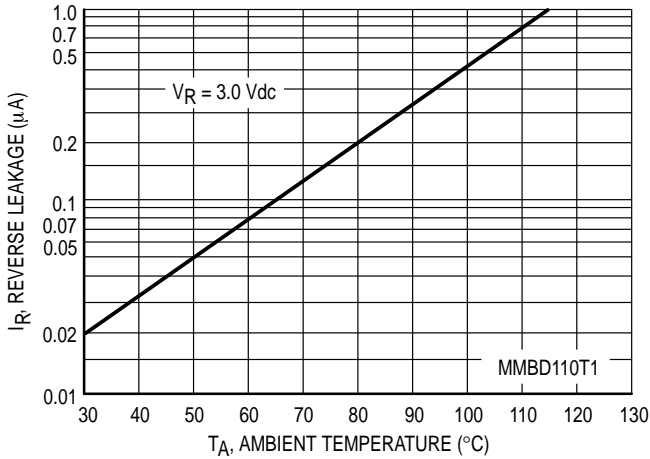

Figure 1. Reverse Leakage

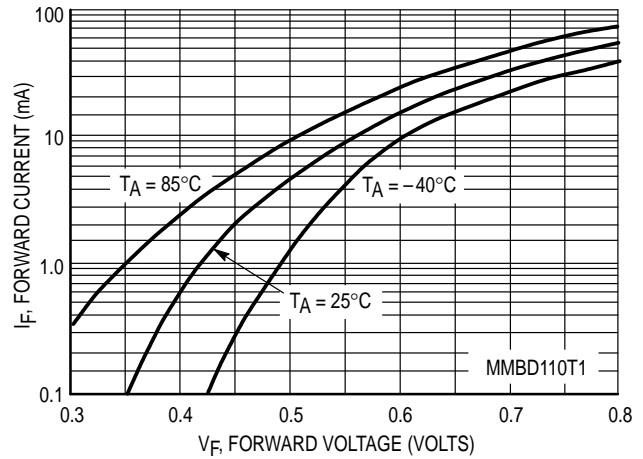

Figure 2. Forward Voltage

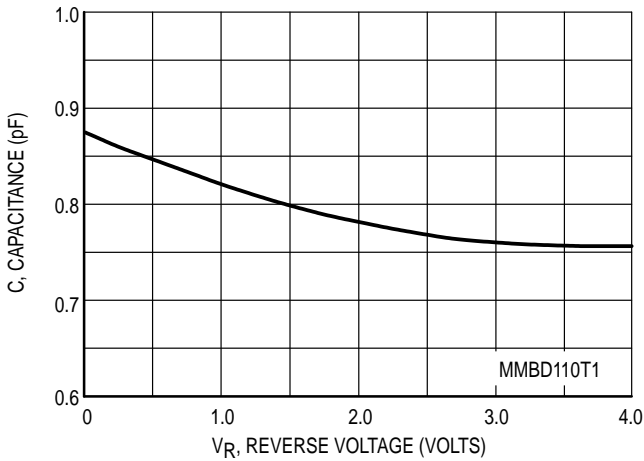

Figure 3. Capacitance

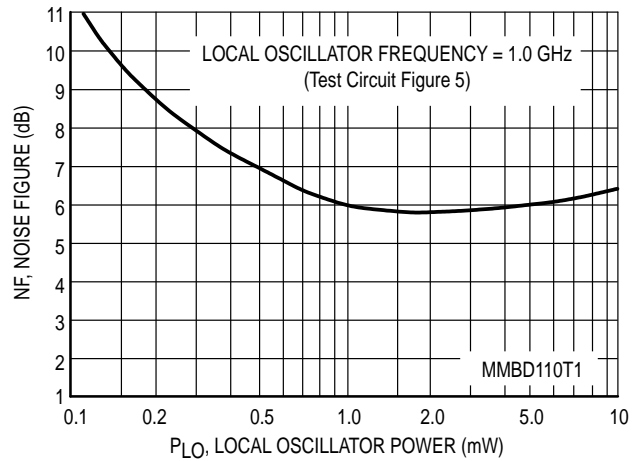

Figure 4. Noise Figure

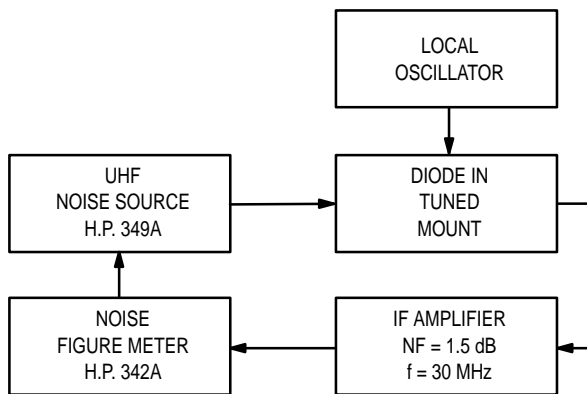

Figure 5. Noise Figure Test Circuit

NOTES ON TESTING AND SPECIFICATIONS

- Note 1 — C_C and C_T are measured using a capacitance bridge (Boonton Electronics Model 75A or equivalent).
- Note 2 — Noise figure measured with diode under test in tuned diode mount using UHF noise source and local oscillator (LO) frequency of 1.0 GHz. The LO power is adjusted for 1.0 mW. IF amplifier NF = 1.5 dB, $f = 30$ MHz, see Figure 5.

TYPICAL CHARACTERISTICS
MMBD330T1

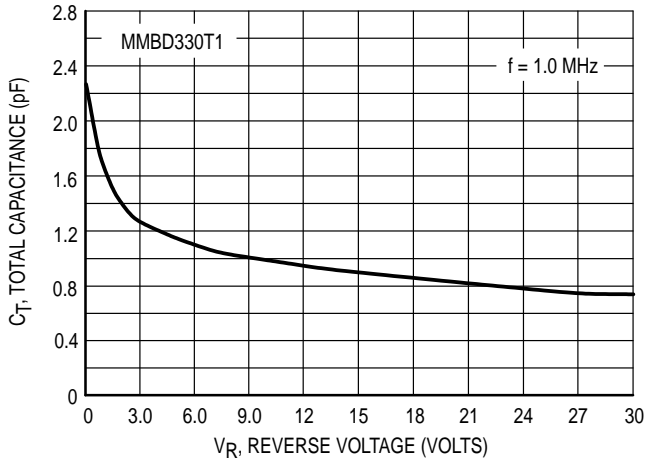

Figure 6. Total Capacitance

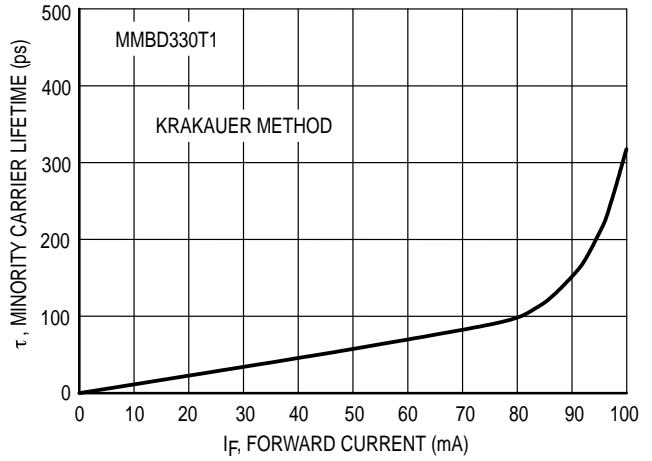

Figure 7. Minority Carrier Lifetime

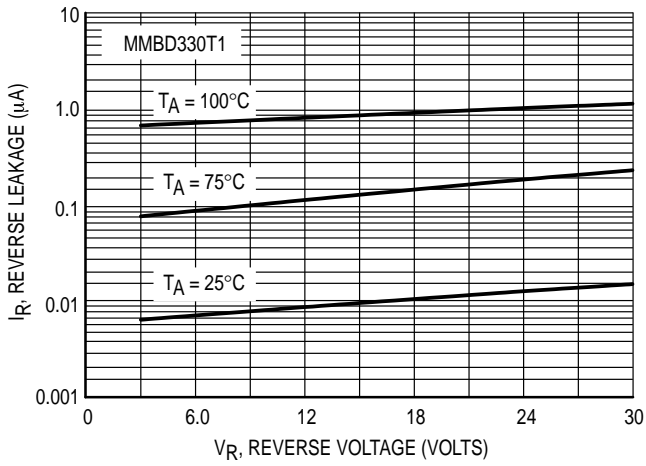

Figure 8. Reverse Leakage

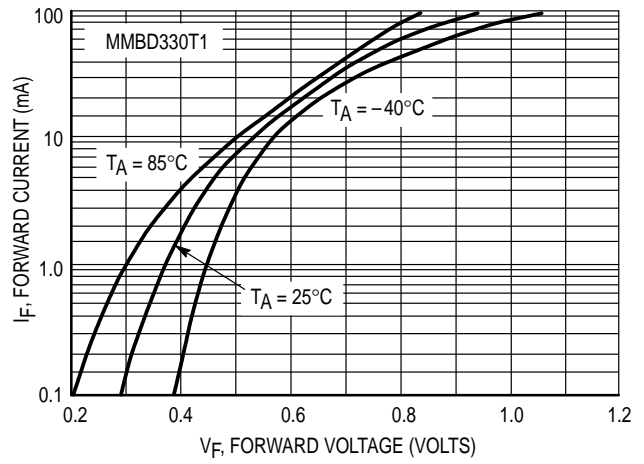

Figure 9. Forward Voltage

TYPICAL CHARACTERISTICS
MMBD770T1

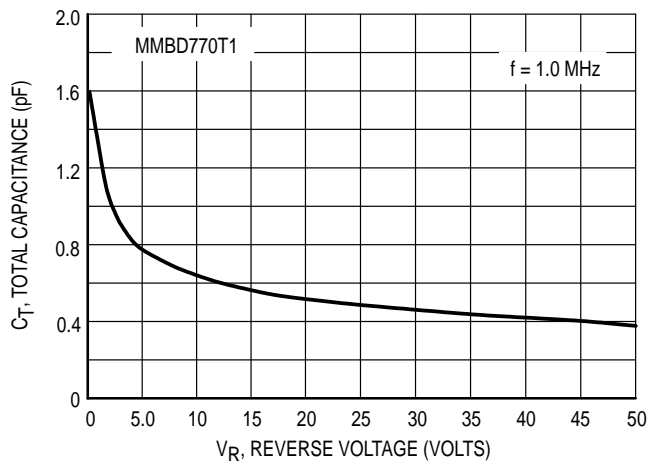

Figure 10. Total Capacitance

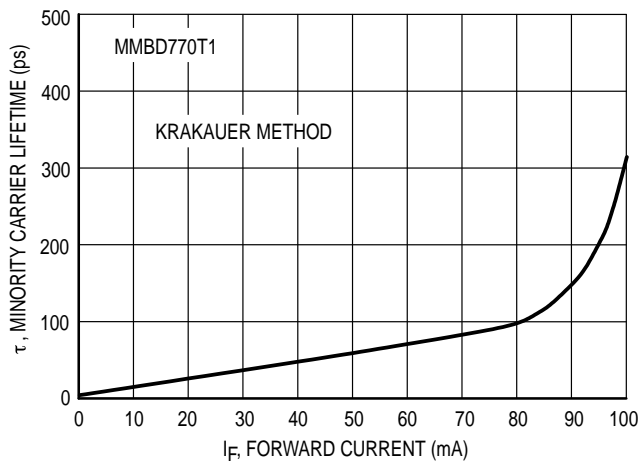

Figure 11. Minority Carrier Lifetime

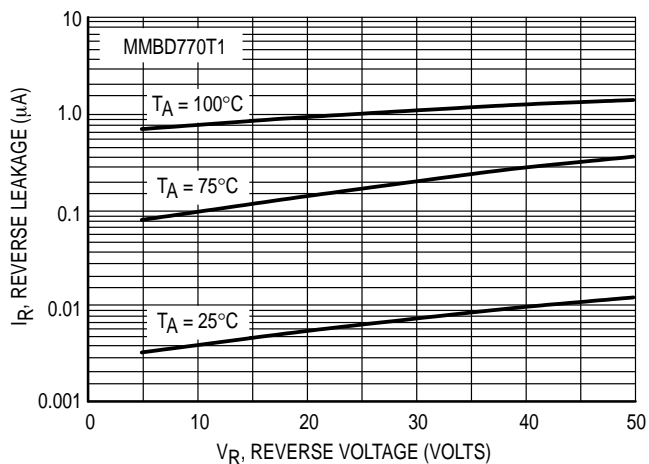

Figure 12. Reverse Leakage

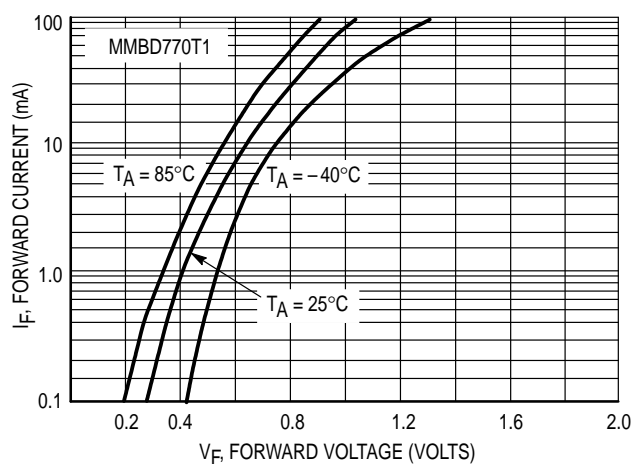

Figure 13. Forward Voltage

INFORMATION FOR USING THE SOT-323/SC-70 SURFACE MOUNT PACKAGE

MINIMUM RECOMMENDED FOOTPRINT FOR SURFACE MOUNTED APPLICATIONS

Surface mount board layout is a critical portion of the total design. The footprint for the semiconductor packages must be the correct size to insure proper solder connection

interface between the board and the package. With the correct pad geometry, the packages will self align when subjected to a solder reflow process.

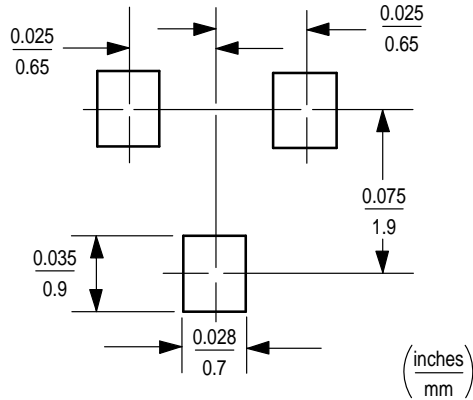

SOT-323/SC-70

SOT-323/SC-70 POWER DISSIPATION

The power dissipation of the SOT-323/SC-70 is a function of the pad size. This can vary from the minimum pad size for soldering to a pad size given for maximum power dissipation. Power dissipation for a surface mount device is determined by $T_{J(max)}$, the maximum rated junction temperature of the die, $R_{\theta JA}$, the thermal resistance from the device junction to ambient, and the operating temperature, T_A . Using the values provided on the data sheet for the SOT-323/SC-70 package, P_D can be calculated as follows:

$$P_D = \frac{T_{J(max)} - T_A}{R_{\theta JA}}$$

The values for the equation are found in the maximum ratings table on the data sheet. Substituting these values into the equation for an ambient temperature T_A of 25°C, one can calculate the power dissipation of the device which in this case is 150 milliwatts.

$$P_D = \frac{150^\circ\text{C} - 25^\circ\text{C}}{833^\circ\text{C/W}} = 150 \text{ milliwatts}$$

The 833°C/W for the SOT-323/SC-70 package assumes the use of the recommended footprint on a glass epoxy printed circuit board to achieve a power dissipation of 150 milliwatts. There are other alternatives to achieving higher power dissipation from the SOT-323/SC-70 package. Another alternative would be to use a ceramic substrate or an aluminum core board such as Thermal Clad™. Using a board material such as Thermal Clad, an aluminum core board, the power dissipation can be doubled using the same footprint.

SOLDERING PRECAUTIONS

The melting temperature of solder is higher than the rated temperature of the device. When the entire device is heated to a high temperature, failure to complete soldering within a short time could result in device failure. Therefore, the following items should always be observed in order to minimize the thermal stress to which the devices are subjected.

- Always preheat the device.
- The delta temperature between the preheat and soldering should be 100°C or less.*
- When preheating and soldering, the temperature of the leads and the case must not exceed the maximum temperature ratings as shown on the data sheet. When using infrared heating with the reflow soldering method, the difference shall be a maximum of 10°C.
- The soldering temperature and time shall not exceed 260°C for more than 10 seconds.
- When shifting from preheating to soldering, the maximum temperature gradient shall be 5°C or less.
- After soldering has been completed, the device should be allowed to cool naturally for at least three minutes. Gradual cooling should be used as the use of forced cooling will increase the temperature gradient and result in latent failure due to mechanical stress.
- Mechanical stress or shock should not be applied during cooling.

* Soldering a device without preheating can cause excessive thermal shock and stress which can result in damage to the device.

PACKAGE DIMENSIONS

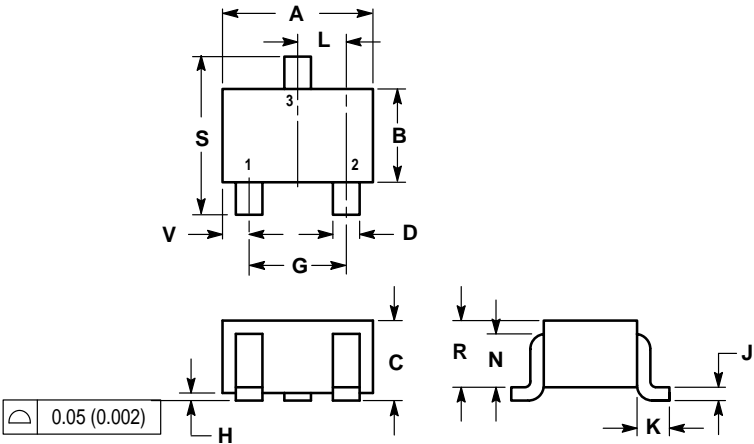

- NOTES:
 1. DIMENSIONING AND TOLERANCING PER ANSI Y14.5M, 1982.
 2. CONTROLLING DIMENSION: INCH.

DIM	INCHES		MILLIMETERS	
	MIN	MAX	MIN	MAX
A	0.071	0.087	1.80	2.20
B	0.045	0.053	1.15	1.35
C	0.035	0.049	0.90	1.25
D	0.012	0.016	0.30	0.40
G	0.047	0.055	1.20	1.40
H	0.000	0.004	0.00	0.10
J	0.004	0.010	0.10	0.25
K	0.017 REF		0.425 REF	
L	0.026 BSC		0.650 BSC	
N	0.028 REF		0.700 REF	
R	0.031	0.039	0.80	1.00
S	0.079	0.087	2.00	2.20
V	0.012	0.016	0.30	0.40

- STYLE 2:
 PIN 1. ANODE
 2. N.C.
 3. CATHODE

**CASE 419-02
 ISSUE G
 SOT-323/SC-70**

Motorola reserves the right to make changes without further notice to any products herein. Motorola makes no warranty, representation or guarantee regarding the suitability of its products for any particular purpose, nor does Motorola assume any liability arising out of the application or use of any product or circuit, and specifically disclaims any and all liability, including without limitation consequential or incidental damages. "Typical" parameters can and do vary in different applications. All operating parameters, including "Typicals" must be validated for each customer application by customer's technical experts. Motorola does not convey any license under its patent rights nor the rights of others. Motorola products are not designed, intended, or authorized for use as components in systems intended for surgical implant into the body, or other applications intended to support or sustain life, or for any other application in which the failure of the Motorola product could create a situation where personal injury or death may occur. Should Buyer purchase or use Motorola products for any such unintended or unauthorized application, Buyer shall indemnify and hold Motorola and its officers, employees, subsidiaries, affiliates, and distributors harmless against all claims, costs, damages, and expenses, and reasonable attorney fees arising out of, directly or indirectly, any claim of personal injury or death associated with such unintended or unauthorized use, even if such claim alleges that Motorola was negligent regarding the design or manufacture of the part. Motorola and  are registered trademarks of Motorola, Inc. Motorola, Inc. is an Equal Opportunity/Affirmative Action Employer.

How to reach us:

USA/EUROPE: Motorola Literature Distribution;
P.O. Box 20912; Phoenix, Arizona 85036. 1-800-441-2447

JAPAN: Nippon Motorola Ltd.; Tatsumi-SPD-JLDC, Toshikatsu Otsuki,
6F Seibu-Butsuryu-Center, 3-14-2 Tatsumi Koto-Ku, Tokyo 135, Japan. 03-3521-8315

MFAX: RMFAX0@email.sps.mot.com – TOUCHTONE (602) 244-6609
INTERNET: <http://Design-NET.com>

HONG KONG: Motorola Semiconductors H.K. Ltd.; 8B Tai Ping Industrial Park,
51 Ting Kok Road, Tai Po, N.T., Hong Kong. 852-26629298

