

PNP Silicon Epitaxial Transistor

This PNP Silicon Epitaxial transistor is designed for use in audio amplifier applications. The device is housed in the SOT-223 package which is designed for medium power surface mount applications.

- High Current: 1.5 Amps
- NPN Complement is BCP56
- The SOT-223 Package can be soldered using wave or reflow. The formed leads absorb thermal stress during soldering, eliminating the possibility of damage to the die
- Available in 12 mm Tape and Reel
Use BCP53T1 to order the 7 inch/1000 unit reel.
Use BCP53T3 to order the 13 inch/4000 unit reel.

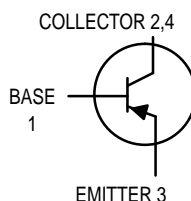

BCP53T1

Motorola Preferred Device

**MEDIUM POWER
PNP SILICON
HIGH CURRENT
TRANSISTOR
SURFACE MOUNT**

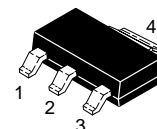

**CASE 318E-04, STYLE 1
TO-261AA**

MAXIMUM RATINGS ($T_C = 25^\circ\text{C}$ unless otherwise noted)

Rating	Symbol	Value	Unit
Collector-Emitter Voltage	V_{CEO}	-80	Vdc
Collector-Base Voltage	V_{CBO}	-100	Vdc
Emitter-Base Voltage	V_{EBO}	-5.0	Vdc
Collector Current	I_C	1.5	Adc
Total Power Dissipation @ $T_A = 25^\circ\text{C}$ (1) Derate above 25°C	P_D	1.5 12	Watts mW/ $^\circ\text{C}$
Operating and Storage Temperature Range	T_J, T_{stg}	-65 to 150	$^\circ\text{C}$

DEVICE MARKING

AH

THERMAL CHARACTERISTICS

Characteristic	Symbol	Max	Unit
Thermal Resistance — Junction-to-Ambient (surface mounted)	$R_{\theta JA}$	83.3	$^\circ\text{C}/\text{W}$
Lead Temperature for Soldering, 0.0625" from case Time in Solder Bath	T_L	260 10	$^\circ\text{C}$ Sec

1. Device mounted on a glass epoxy printed circuit board 1.575 in. x 1.575 in. x 0.059 in.; mounting pad for the collector lead min. 0.93 sq. in.

Thermal Clad is a trademark of the Bergquist Company

Preferred devices are Motorola recommended choices for future use and best overall value.

REV 1

BCP53T1

ELECTRICAL CHARACTERISTICS ($T_A = 25^\circ\text{C}$ unless otherwise noted)

Characteristics	Symbol	Min	Typ	Max	Unit
OFF CHARACTERISTICS					
Collector-Base Breakdown Voltage ($I_C = -100 \mu\text{Adc}$, $I_E = 0$)	$V_{(BR)CBO}$	-100	—	—	Vdc
Collector-Emitter Breakdown Voltage ($I_C = -1.0 \text{ mAdc}$, $I_B = 0$)	$V_{(BR)CEO}$	-80	—	—	Vdc
Collector-Emitter Breakdown Voltage ($I_C = -100 \mu\text{Adc}$, $R_{BE} = 1.0 \text{ kohm}$)	$V_{(BR)CER}$	-100	—	—	Vdc
Emitter-Base Breakdown Voltage ($I_E = -10 \mu\text{Adc}$, $I_C = 0$)	$V_{(BR)EBO}$	-5.0	—	—	Vdc
Collector-Base Cutoff Current ($V_{CB} = -30 \text{ Vdc}$, $I_E = 0$)	I_{CBO}	—	—	-100	nAdc
Emitter-Base Cutoff Current ($V_{EB} = -5.0 \text{ Vdc}$, $I_C = 0$)	I_{EBO}	—	—	-10	μAdc
ON CHARACTERISTICS					
DC Current Gain ($I_C = -5.0 \text{ mAdc}$, $V_{CE} = -2.0 \text{ Vdc}$) ($I_C = -150 \text{ mAdc}$, $V_{CE} = -2.0 \text{ Vdc}$) ($I_C = -500 \text{ mAdc}$, $V_{CE} = -2.0 \text{ Vdc}$)	h_{FE}	25 40 25	— — —	— 250 —	—
Collector-Emitter Saturation Voltage ($I_C = -500 \text{ mAdc}$, $I_B = -50 \text{ mAdc}$)	$V_{CE(sat)}$	—	—	-0.5	Vdc
Base-Emitter On Voltage ($I_C = -500 \text{ mAdc}$, $V_{CE} = -2.0 \text{ Vdc}$)	$V_{BE(on)}$	—	—	-1.0	Vdc
DYNAMIC CHARACTERISTICS					
Current-Gain — Bandwidth Product ($I_C = -10 \text{ mAdc}$, $V_{CE} = -5.0 \text{ Vdc}$, $f = 35 \text{ MHz}$)	f_T	—	50	—	MHz

TYPICAL ELECTRICAL CHARACTERISTICS

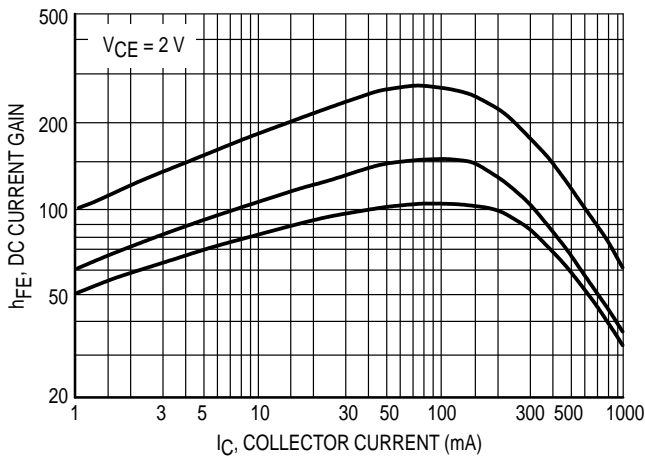

Figure 1. DC Current Gain

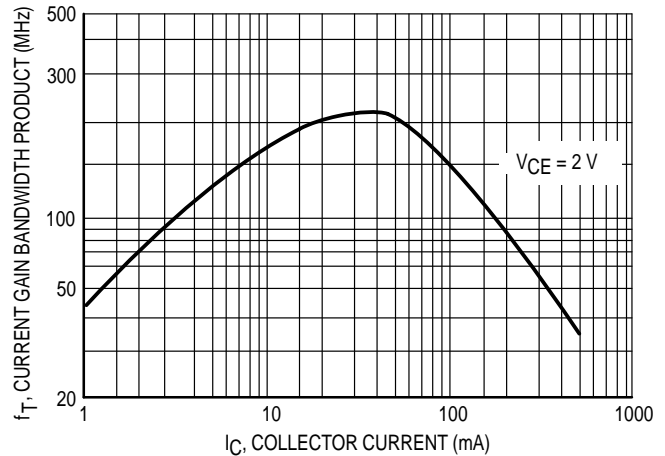

Figure 2. Current Gain Bandwidth Product

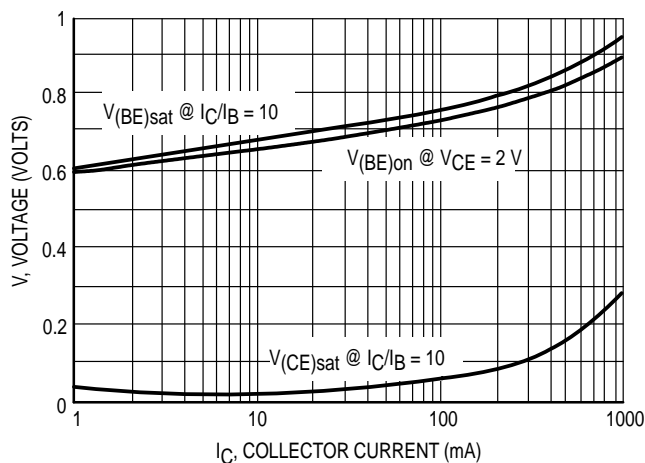

Figure 3. Saturation and "ON" Voltages

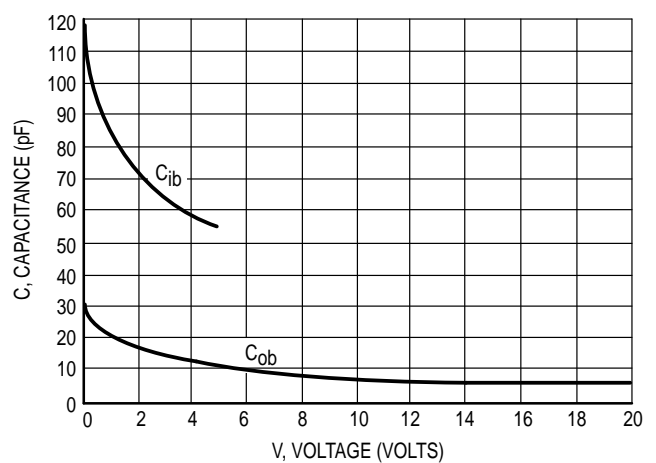

Figure 4. Capacitances

INFORMATION FOR USING THE SOT-223 SURFACE MOUNT PACKAGE

POWER DISSIPATION

The power dissipation of the SOT-223 is a function of the input pad size. These can vary from the minimum pad size for soldering to the pad size given for maximum power dissipation. Power dissipation for a surface mount device is determined by $T_{J(max)}$, the maximum rated junction temperature of the die, $R_{\theta JA}$, the thermal resistance from the device junction to ambient; and the operating temperature, T_A . Using the values provided on the data sheet for the SOT-223 package, P_D can be calculated as follows.

$$P_D = \frac{T_{J(max)} - T_A}{R_{\theta JA}}$$

The values for the equation are found in the maximum ratings table on the data sheet. Substituting these values into

the equation for an ambient temperature T_A of 25°C, one can calculate the power dissipation of the device which in this case is 1.5 watts.

$$P_D = \frac{150^\circ\text{C} - 25^\circ\text{C}}{83.3^\circ\text{C/W}} = 1.5 \text{ watts}$$

The 83.3°C/W for the SOT-223 package assumes the recommended collector pad area of 965 sq. mils on a glass epoxy printed circuit board to achieve a power dissipation of 1.5 watts. If space is at a premium, a more realistic approach is to use the device at a P_D of 833 mW using the footprint shown. Using a board material such as Thermal Clad, a power dissipation of 1.6 watts can be achieved using the same footprint.

MOUNTING PRECAUTIONS

The melting temperature of solder is higher than the rated temperature of the device. When the entire device is heated to a high temperature, failure to complete soldering within a short time could result in device failure. Therefore, the following items should always be observed in order to minimize the thermal stress to which the devices are subjected.

- Always preheat the device.
- The delta temperature between the preheat and soldering should be 100°C or less.*
- When preheating and soldering, the temperature of the leads and the case must not exceed the maximum temperature ratings as shown on the data sheet. When using infrared heating with the reflow soldering method, the difference should be a maximum of 10°C.

- The soldering temperature and time should not exceed 260°C for more than 10 seconds.
- When shifting from preheating to soldering, the maximum temperature gradient should be 5°C or less.
- After soldering has been completed, the device should be allowed to cool naturally for at least three minutes. Gradual cooling should be used as the use of forced cooling will increase the temperature gradient and result in latent failure due to mechanical stress.
- Mechanical stress or shock should not be applied during cooling

* Soldering a device without preheating can cause excessive thermal shock and stress which can result in damage to the device.

MINIMUM RECOMMENDED FOOTPRINT FOR SURFACE MOUNTED APPLICATIONS

Surface mount board layout is a critical portion of the total design. The footprint for the semiconductor packages must be the correct size to insure proper solder connection

interface between the board and the package. With the correct pad geometry, the packages will self align when subjected to a solder reflow process.

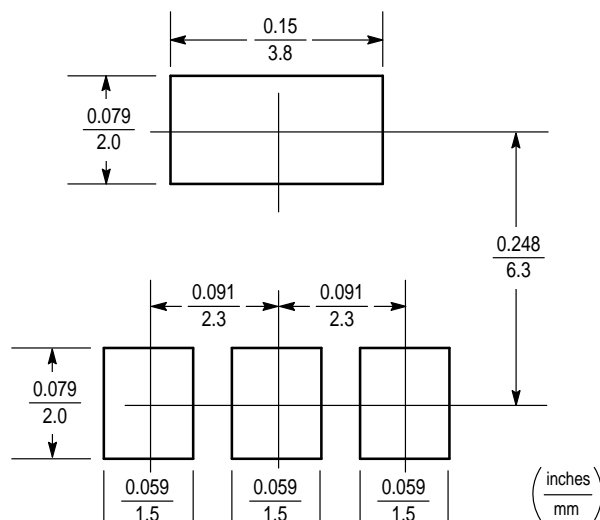

SOT-223

PACKAGE DIMENSIONS

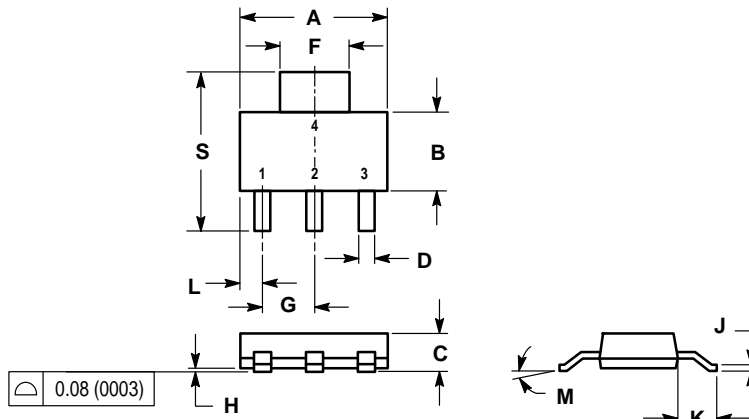

- NOTES:
 1. DIMENSIONING AND TOLERANCING PER ANSI Y14.5M, 1982.
 2. CONTROLLING DIMENSION: INCH.

DIM	INCHES		MILLIMETERS	
	MIN	MAX	MIN	MAX
A	0.249	0.263	6.30	6.70
B	0.130	0.145	3.30	3.70
C	0.060	0.068	1.50	1.75
D	0.024	0.035	0.60	0.89
F	0.115	0.126	2.90	3.20
G	0.087	0.094	2.20	2.40
H	0.0008	0.0040	0.020	0.100
J	0.009	0.014	0.24	0.35
K	0.060	0.078	1.50	2.00
L	0.033	0.041	0.85	1.05
M	0°	10°	0°	10°
S	0.264	0.287	6.70	7.30

- STYLE 1:
 PIN 1. BASE
 2. COLLECTOR
 3. EMITTER
 4. COLLECTOR

CASE 318E-04
 ISSUE H
 TO-261AA

Motorola reserves the right to make changes without further notice to any products herein. Motorola makes no warranty, representation or guarantee regarding the suitability of its products for any particular purpose, nor does Motorola assume any liability arising out of the application or use of any product or circuit, and specifically disclaims any and all liability, including without limitation consequential or incidental damages. "Typical" parameters which may be provided in Motorola data sheets and/or specifications can and do vary in different applications and actual performance may vary over time. All operating parameters, including "Typicals" must be validated for each customer application by customer's technical experts. Motorola does not convey any license under its patent rights nor the rights of others. Motorola products are not designed, intended, or authorized for use as components in systems intended for surgical implant into the body, or other applications intended to support or sustain life, or for any other application in which the failure of the Motorola product could create a situation where personal injury or death may occur. Should Buyer purchase or use Motorola products for any such unintended or unauthorized application, Buyer shall indemnify and hold Motorola and its officers, employees, subsidiaries, affiliates, and distributors harmless against all claims, costs, damages, and expenses, and reasonable attorney fees arising out of, directly or indirectly, any claim of personal injury or death associated with such unintended or unauthorized use, even if such claim alleges that Motorola was negligent regarding the design or manufacture of the part. Motorola and are registered trademarks of Motorola, Inc. Motorola, Inc. is an Equal Opportunity/Affirmative Action Employer.

Mfax is a trademark of Motorola, Inc.

How to reach us:

USA/EUROPE/Locations Not Listed: Motorola Literature Distribution;
 P.O. Box 5405, Denver, Colorado 80217. 303-675-2140 or 1-800-441-2447

JAPAN: Nippon Motorola Ltd.; Tatsumi-SPD-JLDC, 6F Seibu-Butsuryu-Center,
 3-14-2 Tatsumi Koto-Ku, Tokyo 135, Japan. 81-3-3521-8315

Mfax™: RMFAX0@email.sps.mot.com – TOUCHTONE 602-244-6609
 – US & Canada ONLY 1-800-774-1848

ASIA/PACIFIC: Motorola Semiconductors H.K. Ltd.; 8B Tai Ping Industrial Park,
 51 Ting Kok Road, Tai Po, N.T., Hong Kong. 852-26629298

INTERNET: <http://motorola.com/sps>

