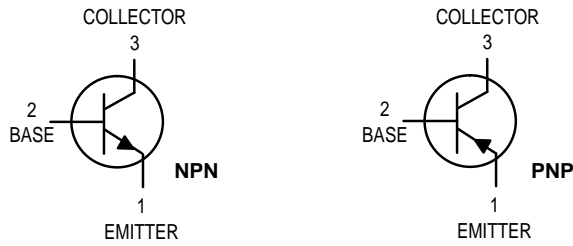
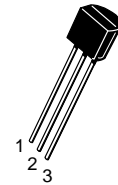


# High Voltage Transistors



**NPN**  
**2N6515**  
**2N6517**  
**PNP**  
**2N6519**  
**2N6520**

Voltage and current are negative  
for PNP transistors



**CASE 29-04, STYLE 1**  
**TO-92 (TO-226AA)**

## MAXIMUM RATINGS

Rating	Symbol	2N6515	2N6519	2N6517 2N6520	Unit
Collector–Emitter Voltage	$V_{CEO}$	250	300	350	Vdc
Collector–Base Voltage	$V_{CBO}$	250	300	350	Vdc
Emitter–Base Voltage 2N6515, 2N6516, 2N6517 2N6519, 2N6520	$V_{EBO}$	6.0 5.0			Vdc
Base Current	$I_B$	250			mAdc
Collector Current — Continuous	$I_C$	500			mAdc
Total Device Dissipation @ $T_A = 25^\circ\text{C}$ Derate above $25^\circ\text{C}$	$P_D$	625 5.0			mW mW/°C
Total Device Dissipation @ $T_C = 25^\circ\text{C}$ Derate above $25^\circ\text{C}$	$P_D$	1.5 12			Watts mW/°C
Operating and Storage Junction Temperature Range	$T_J, T_{stg}$	–55 to +150			°C

## THERMAL CHARACTERISTICS

Characteristic	Symbol	Max	Unit
Thermal Resistance, Junction to Ambient	$R_{\theta JA}$	200	°C/W
Thermal Resistance, Junction to Case	$R_{\theta JC}$	83.3	°C/W

## ELECTRICAL CHARACTERISTICS ( $T_A = 25^\circ\text{C}$ unless otherwise noted)

Characteristic	Symbol	Min	Max	Unit
----------------	--------	-----	-----	------

## OFF CHARACTERISTICS

Collector–Emitter Breakdown Voltage <sup>(1)</sup> ( $I_C = 1.0 \text{ mAdc}, I_B = 0$ )	$V_{(BR)CEO}$	250 300 350	— — —	Vdc
Collector–Base Breakdown Voltage ( $I_C = 100 \mu\text{Adc}, I_E = 0$ )	$V_{(BR)CBO}$	250 300 350	— — —	Vdc
Emitter–Base Breakdown Voltage ( $I_E = 10 \mu\text{Adc}, I_C = 0$ )	$V_{(BR)EBO}$	6.0 5.0	— —	Vdc

1. Pulse Test: Pulse Width  $\leq 300 \mu\text{s}$ , Duty Cycle  $\leq 2.0\%$ .



## NPN 2N6515 2N6517 PNP 2N6519 2N6520

### ELECTRICAL CHARACTERISTICS ( $T_A = 25^\circ\text{C}$ unless otherwise noted) (Continued)

Characteristic	Symbol	Min	Max	Unit
----------------	--------	-----	-----	------

#### OFF CHARACTERISTICS (Continued)

Collector Cutoff Current ( $V_{CB} = 150\text{ Vdc}$ , $I_E = 0$ ) ( $V_{CB} = 200\text{ Vdc}$ , $I_E = 0$ ) ( $V_{CB} = 250\text{ Vdc}$ , $I_E = 0$ )	2N6515 2N6519 2N6517, 2N6520	$I_{CBO}$	— — —	50 50 50	nA <sub>dc</sub>
Emitter Cutoff Current ( $V_{EB} = 5.0\text{ Vdc}$ , $I_C = 0$ ) ( $V_{EB} = 4.0\text{ Vdc}$ , $I_C = 0$ )	2N6515, 2N6517 2N6519, 2N6520	$I_{EBO}$	— —	50 50	nA <sub>dc</sub>

#### ON CHARACTERISTICS(1)

DC Current Gain ( $I_C = 1.0\text{ mAdc}$ , $V_{CE} = 10\text{ Vdc}$ )  ( $I_C = 10\text{ mAdc}$ , $V_{CE} = 10\text{ Vdc}$ )  ( $I_C = 30\text{ mAdc}$ , $V_{CE} = 10\text{ Vdc}$ )  ( $I_C = 50\text{ mAdc}$ , $V_{CE} = 10\text{ Vdc}$ )  ( $I_C = 100\text{ mAdc}$ , $V_{CE} = 10\text{ Vdc}$ )	2N6515 2N6519 2N6517, 2N6520  2N6515 2N6519 2N6517, 2N6520  2N6515 2N6519 2N6517, 2N6520  2N6515 2N6519 2N6517, 2N6520	$h_{FE}$	35 30 20  50 45 30  50 45 30  45 40 20  25 20 15	— — —  — — —  300 270 200  220 200 200  — — —	—
Collector–Emitter Saturation Voltage ( $I_C = 10\text{ mAdc}$ , $I_B = 1.0\text{ mAdc}$ ) ( $I_C = 20\text{ mAdc}$ , $I_B = 2.0\text{ mAdc}$ ) ( $I_C = 30\text{ mAdc}$ , $I_B = 3.0\text{ mAdc}$ ) ( $I_C = 50\text{ mAdc}$ , $I_B = 5.0\text{ mAdc}$ )		$V_{CE(sat)}$	— — — —	0.30 0.35 0.50 1.0	V <sub>dc</sub>
Base–Emitter Saturation Voltage ( $I_C = 10\text{ mAdc}$ , $I_B = 1.0\text{ mAdc}$ ) ( $I_C = 20\text{ mAdc}$ , $I_B = 2.0\text{ mAdc}$ ) ( $I_C = 30\text{ mAdc}$ , $I_B = 3.0\text{ mAdc}$ )		$V_{BE(sat)}$	— — —	0.75 0.85 0.90	V <sub>dc</sub>
Base–Emitter On Voltage ( $I_C = 100\text{ mAdc}$ , $V_{CE} = 10\text{ Vdc}$ )		$V_{BE(on)}$	—	2.0	V <sub>dc</sub>

#### SMALL–SIGNAL CHARACTERISTICS

Current–Gain — Bandwidth Product(1) ( $I_C = 10\text{ mAdc}$ , $V_{CE} = 20\text{ Vdc}$ , $f = 20\text{ MHz}$ )		$f_T$	40	200	MHz
Collector–Base Capacitance ( $V_{CB} = 20\text{ Vdc}$ , $I_E = 0$ , $f = 1.0\text{ MHz}$ )		$C_{cb}$	—	6.0	pF
Emitter–Base Capacitance ( $V_{EB} = 0.5\text{ Vdc}$ , $I_C = 0$ , $f = 1.0\text{ MHz}$ )	2N6515, 2N6517 2N6519, 2N6520	$C_{eb}$	— —	80 100	pF

#### SWITCHING CHARACTERISTICS

Turn–On Time ( $V_{CC} = 100\text{ Vdc}$ , $V_{BE(off)} = 2.0\text{ Vdc}$ , $I_C = 50\text{ mAdc}$ , $I_{B1} = 10\text{ mAdc}$ )		$t_{on}$	—	200	$\mu\text{s}$
Turn–Off Time ( $V_{CC} = 100\text{ Vdc}$ , $I_C = 50\text{ mAdc}$ , $I_{B1} = I_{B2} = 10\text{ mAdc}$ )		$t_{off}$	—	3.5	$\mu\text{s}$

1. Pulse Test: Pulse Width  $\leq 300\ \mu\text{s}$ , Duty Cycle  $\leq 2.0\%$ .

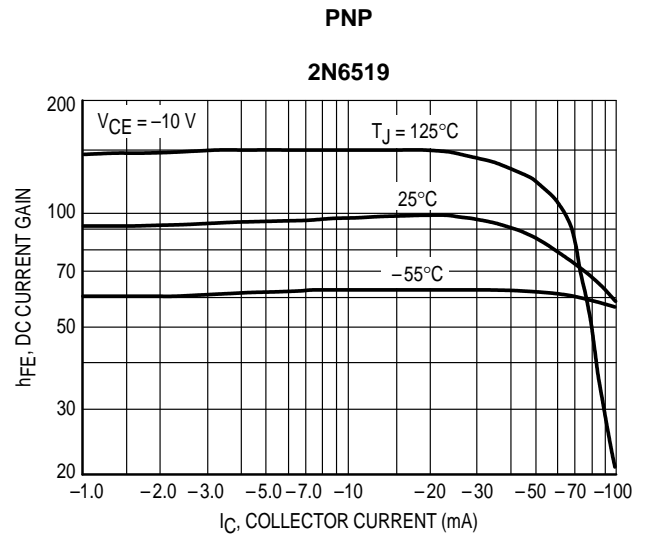
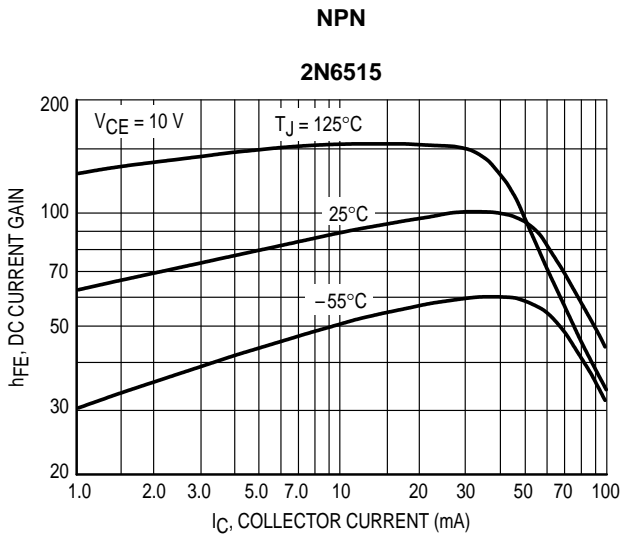


Figure 1. DC Current Gain

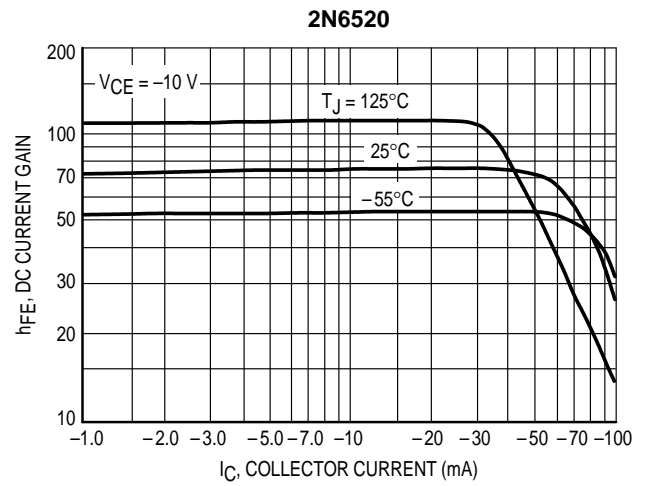
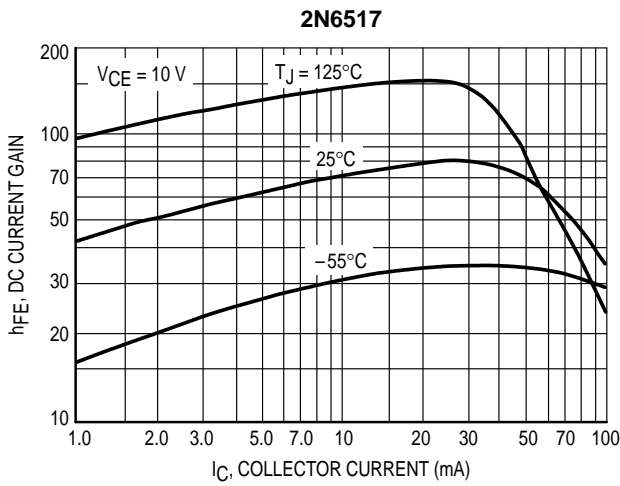


Figure 2. DC Current Gain

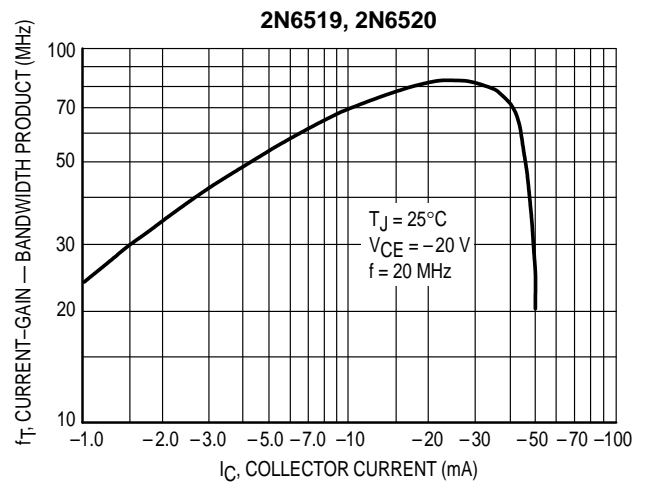
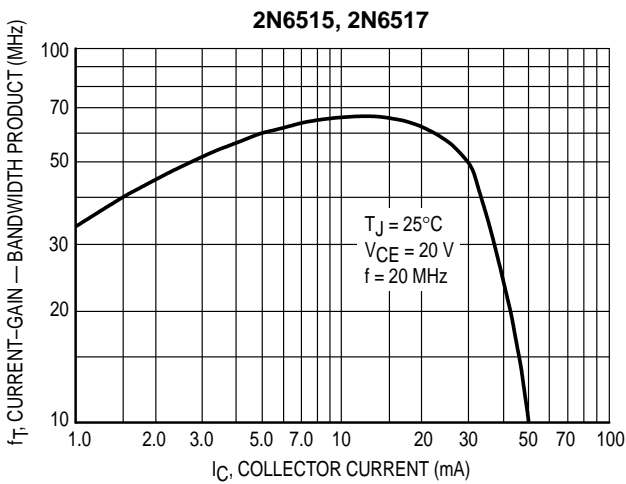
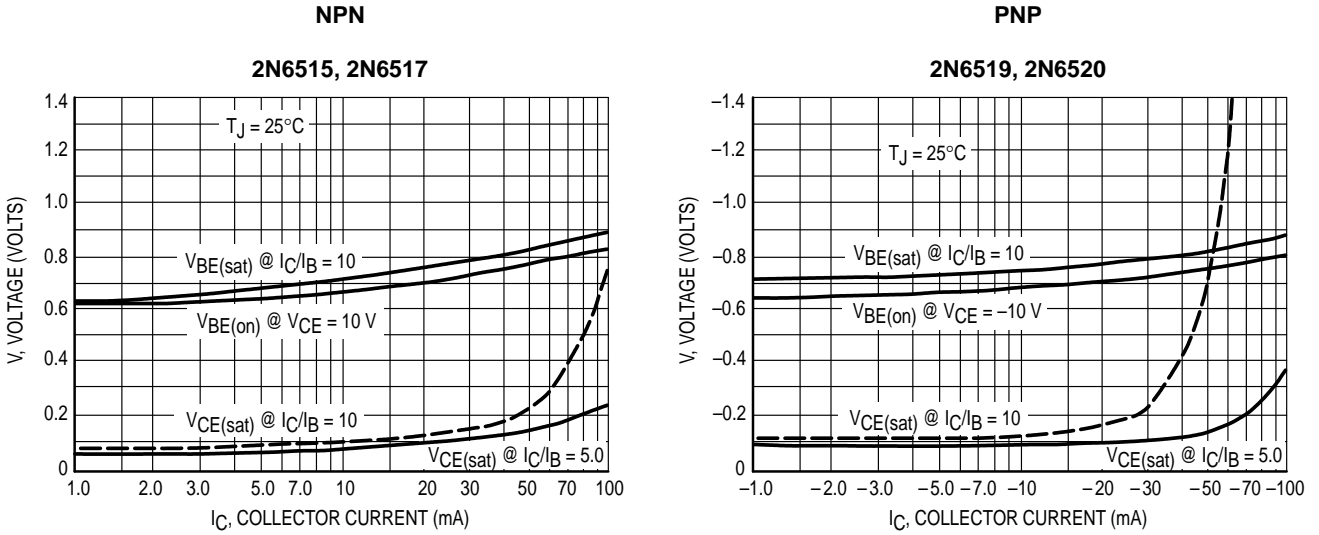
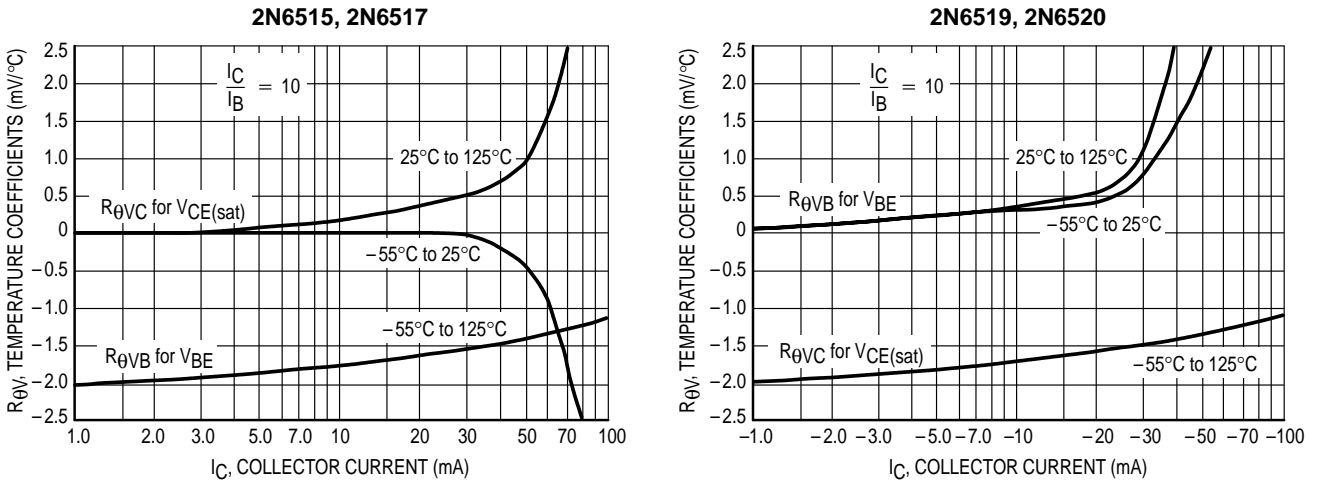


Figure 3. Current-Gain — Bandwidth Product

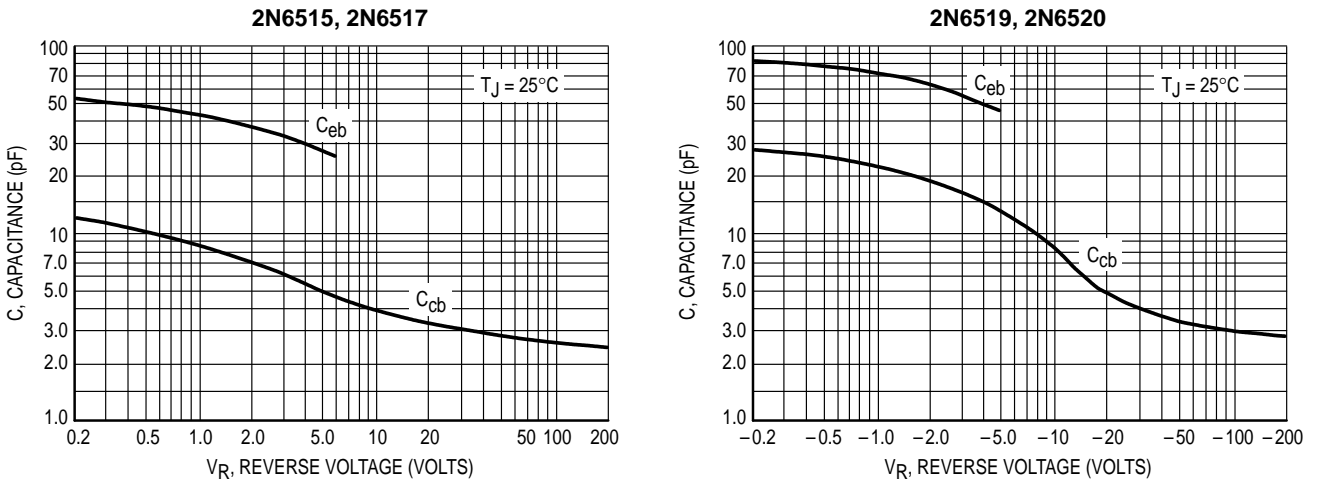
**NPN 2N6515 2N6517 PNP 2N6519 2N6520**



**Figure 4. "On" Voltages**



**Figure 5. Temperature Coefficients**



**Figure 6. Capacitance**

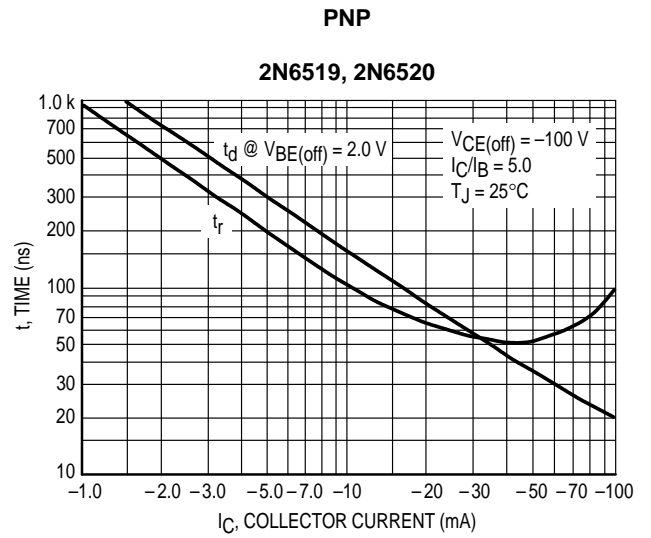
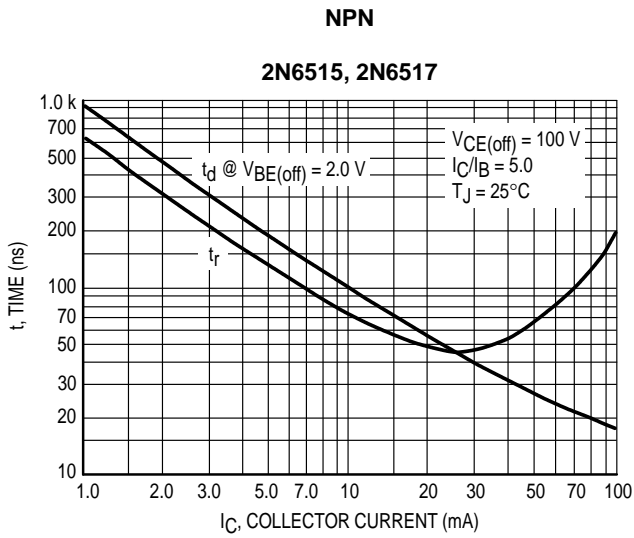


Figure 7. Turn-On Time

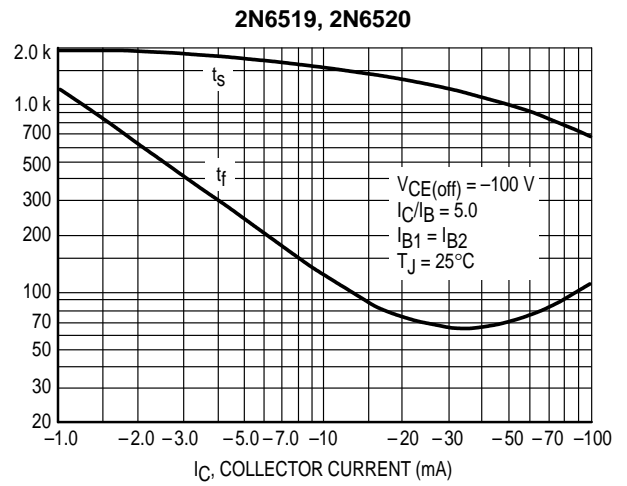
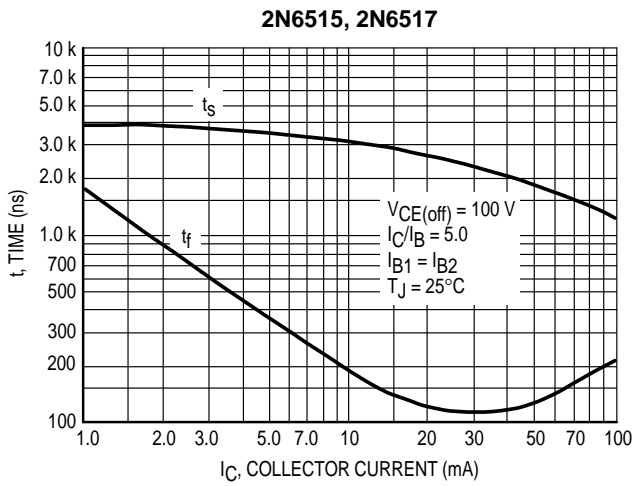
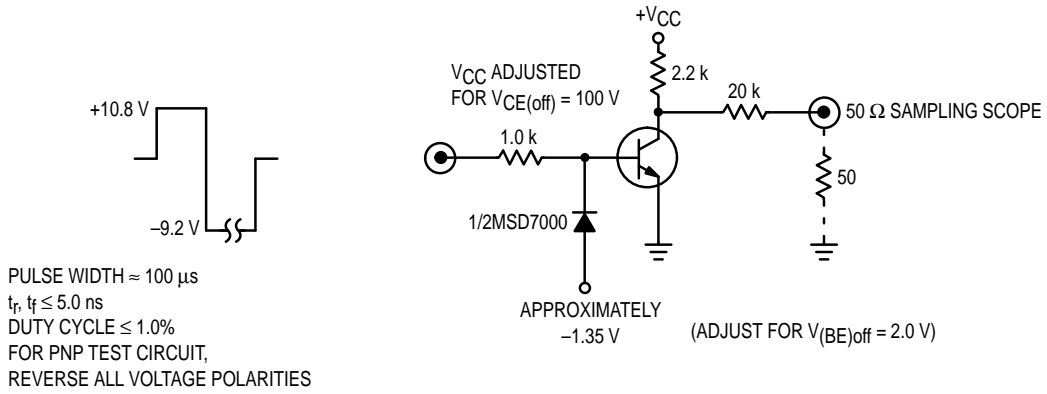
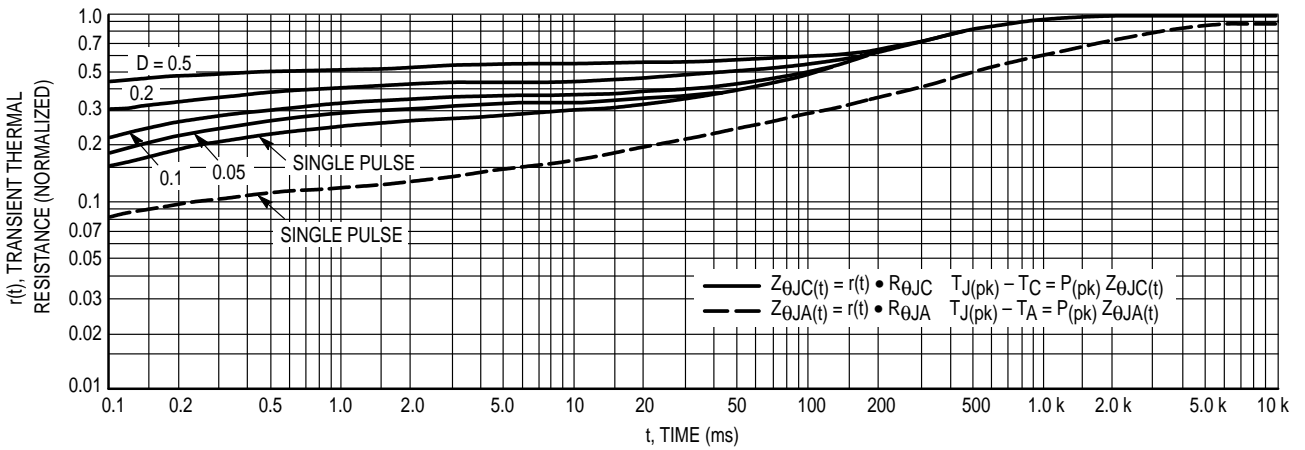


Figure 8. Turn-Off Time

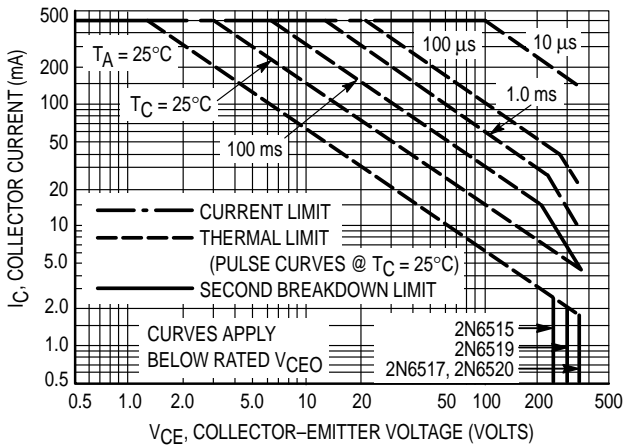
**NPN 2N6515 2N6517 PNP 2N6519 2N6520**



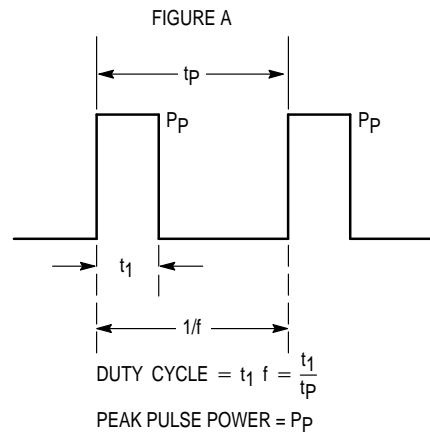
**Figure 9. Switching Time Test Circuit**



**Figure 10. Thermal Response**

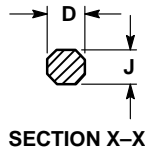
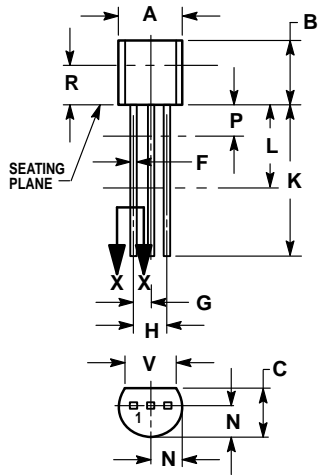


**Figure 11. Active Region Safe Operating Area**



**Design Note: Use of Transient Thermal Resistance Data**

PACKAGE DIMENSIONS



CASE 029-04  
(TO-226AA)  
ISSUE AD

NOTES:


1. DIMENSIONING AND TOLERANCING PER ANSI Y14.5M, 1982.
2. CONTROLLING DIMENSION: INCH.
3. CONTOUR OF PACKAGE BEYOND DIMENSION R IS UNCONTROLLED.
4. DIMENSION F APPLIES BETWEEN P AND L. DIMENSION D AND J APPLY BETWEEN L AND K MINIMUM. LEAD DIMENSION IS UNCONTROLLED IN P AND BEYOND DIMENSION K MINIMUM.

DIM	INCHES		MILLIMETERS	
	MIN	MAX	MIN	MAX
A	0.175	0.205	4.45	5.20
B	0.170	0.210	4.32	5.33
C	0.125	0.165	3.18	4.19
D	0.016	0.022	0.41	0.55
F	0.016	0.019	0.41	0.48
G	0.045	0.055	1.15	1.39
H	0.095	0.105	2.42	2.66
J	0.015	0.020	0.39	0.50
K	0.500	—	12.70	—
L	0.250	—	6.35	—
N	0.080	0.105	2.04	2.66
P	—	0.100	—	2.54
R	0.115	—	2.93	—
V	0.135	—	3.43	—

STYLE 1:

- PIN 1. EMITTER
2. BASE
3. COLLECTOR

**NPN 2N6515 2N6517 PNP 2N6519 2N6520**

Motorola reserves the right to make changes without further notice to any products herein. Motorola makes no warranty, representation or guarantee regarding the suitability of its products for any particular purpose, nor does Motorola assume any liability arising out of the application or use of any product or circuit, and specifically disclaims any and all liability, including without limitation consequential or incidental damages. "Typical" parameters which may be provided in Motorola data sheets and/or specifications can and do vary in different applications and actual performance may vary over time. All operating parameters, including "Typicals" must be validated for each customer application by customer's technical experts. Motorola does not convey any license under its patent rights nor the rights of others. Motorola products are not designed, intended, or authorized for use as components in systems intended for surgical implant into the body, or other applications intended to support or sustain life, or for any other application in which the failure of the Motorola product could create a situation where personal injury or death may occur. Should Buyer purchase or use Motorola products for any such unintended or unauthorized application, Buyer shall indemnify and hold Motorola and its officers, employees, subsidiaries, affiliates, and distributors harmless against all claims, costs, damages, and expenses, and reasonable attorney fees arising out of, directly or indirectly, any claim of personal injury or death associated with such unintended or unauthorized use, even if such claim alleges that Motorola was negligent regarding the design or manufacture of the part. Motorola and  are registered trademarks of Motorola, Inc. Motorola, Inc. is an Equal Opportunity/Affirmative Action Employer.

Mfax is a trademark of Motorola, Inc.

**How to reach us:**

**USA/EUROPE/Locations Not Listed:** Motorola Literature Distribution;  
P.O. Box 5405, Denver, Colorado 80217. 303-675-2140 or 1-800-441-2447

**JAPAN:** Nippon Motorola Ltd.: SPD, Strategic Planning Office, 4-32-1,  
Nishi-Gotanda, Shinagawa-ku, Tokyo 141, Japan. 81-3-5487-8488

**Mfax™:** RMFAX0@email.sps.mot.com – TOUCHTONE 602-244-6609  
– US & Canada ONLY 1-800-774-1848

**ASIA/PACIFIC:** Motorola Semiconductors H.K. Ltd.; 8B Tai Ping Industrial Park,  
51 Ting Kok Road, Tai Po, N.T., Hong Kong. 852-26629298

**INTERNET:** <http://motorola.com/sps>

