

# High Voltage Transistor

## NPN Silicon

# MPSA44

Motorola Preferred Device

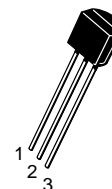
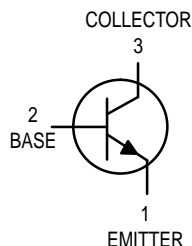

CASE 29-04, STYLE 1  
TO-92 (TO-226AA)

### MAXIMUM RATINGS

Rating	Symbol	Value	Unit
Collector–Emitter Voltage	$V_{CEO}$	400	Vdc
Collector–Base Voltage	$V_{CBO}$	500	Vdc
Emitter–Base Voltage	$V_{EBO}$	6.0	Vdc
Collector Current — Continuous	$I_C$	300	mAdc
Total Device Dissipation @ $T_A = 25^\circ\text{C}$ Derate above $25^\circ\text{C}$	$P_D$	625 5.0	mW mW/ $^\circ\text{C}$
Total Device Dissipation @ $T_C = 25^\circ\text{C}$ Derate above $25^\circ\text{C}$	$P_D$	1.5 12	Watts mW/ $^\circ\text{C}$
Operating and Storage Junction Temperature Range	$T_J, T_{stg}$	-55 to +150	$^\circ\text{C}$

### THERMAL CHARACTERISTICS

Characteristic	Symbol	Max	Unit
Thermal Resistance, Junction to Ambient	$R_{\theta JA}$	200	$^\circ\text{C}/\text{W}$
Thermal Resistance, Junction to Case	$R_{\theta JC}$	83.3	$^\circ\text{C}/\text{W}$

### ELECTRICAL CHARACTERISTICS ( $T_A = 25^\circ\text{C}$ unless otherwise noted)

Characteristic	Symbol	Min	Max	Unit
----------------	--------	-----	-----	------

### OFF CHARACTERISTICS

Collector–Emitter Breakdown Voltage <sup>(1)</sup> ( $I_C = 1.0 \text{ mAdc}, I_B = 0$ )	$V_{(BR)CEO}$	400	—	Vdc
Collector–Emitter Breakdown Voltage ( $I_C = 100 \mu\text{Adc}, V_{BE} = 0$ )	$V_{(BR)CES}$	500	—	Vdc
Collector–Base Breakdown Voltage ( $I_C = 100 \mu\text{Adc}, I_E = 0$ )	$V_{(BR)CBO}$	500	—	Vdc
Emitter–Base Breakdown Voltage ( $I_E = 10 \mu\text{Adc}, I_C = 0$ )	$V_{(BR)EBO}$	6.0	—	Vdc
Collector Cutoff Current ( $V_{CB} = 400 \text{ Vdc}, I_E = 0$ )	$I_{CBO}$	—	0.1	$\mu\text{Adc}$
Collector Cutoff Current ( $V_{CE} = 400 \text{ Vdc}, V_{BE} = 0$ )	$I_{CES}$	—	500	nAdc
Emitter Cutoff Current ( $V_{EB} = 4.0 \text{ Vdc}, I_C = 0$ )	$I_{EBO}$	—	0.1	$\mu\text{Adc}$

1. Pulse Test: Pulse Width  $\leq 300 \mu\text{s}$ , Duty Cycle  $\leq 2.0\%$ .

Preferred devices are Motorola recommended choices for future use and best overall value.

**MPSA44****ELECTRICAL CHARACTERISTICS** ( $T_A = 25^\circ\text{C}$  unless otherwise noted) (Continued)

Characteristic	Symbol	Min	Max	Unit
<b>ON CHARACTERISTICS(1)</b>				
DC Current Gain <sup>(1)</sup> ( $I_C = 1.0 \text{ mAdc}$ , $V_{CE} = 10 \text{ Vdc}$ ) ( $I_C = 10 \text{ mAdc}$ , $V_{CE} = 10 \text{ Vdc}$ ) ( $I_C = 50 \text{ mAdc}$ , $V_{CE} = 10 \text{ Vdc}$ ) ( $I_C = 100 \text{ mAdc}$ , $V_{CE} = 10 \text{ Vdc}$ )	$h_{FE}$	40 50 45 40	— 200 — —	—
Collector–Emitter Saturation Voltage <sup>(1)</sup> ( $I_C = 1.0 \text{ mAdc}$ , $I_B = 0.1 \text{ mAdc}$ ) ( $I_C = 10 \text{ mAdc}$ , $I_B = 1.0 \text{ mAdc}$ ) ( $I_C = 50 \text{ mAdc}$ , $I_B = 5.0 \text{ mAdc}$ )	$V_{CE(sat)}$	— — —	0.4 0.5 0.75	Vdc
Base–Emitter Saturation Voltage ( $I_C = 10 \text{ mAdc}$ , $I_B = 1.0 \text{ mAdc}$ )	$V_{BE(sat)}$	—	0.75	Vdc
<b>SMALL–SIGNAL CHARACTERISTICS</b>				
Output Capacitance ( $V_{CB} = 20 \text{ Vdc}$ , $I_E = 0$ , $f = 1.0 \text{ MHz}$ )	$C_{obo}$	—	7.0	pF
Input Capacitance ( $V_{EB} = 0.5 \text{ Vdc}$ , $I_C = 0$ , $f = 1.0 \text{ MHz}$ )	$C_{ibo}$	—	130	pF
Small–Signal Current Gain ( $I_C = 10 \text{ mAdc}$ , $V_{CE} = 10 \text{ Vdc}$ , $f = 20 \text{ MHz}$ )	$h_{fe}$	1.0	—	—

1. Pulse Test: Pulse Width  $\leq 300 \mu\text{s}$ , Duty Cycle  $\leq 2.0\%$ .

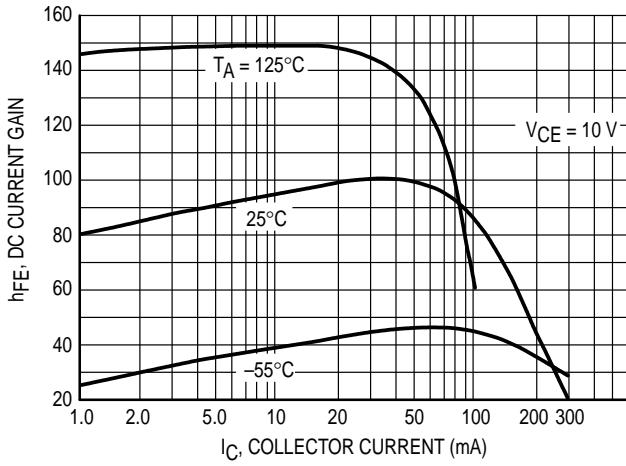

Figure 1. DC Current Gain

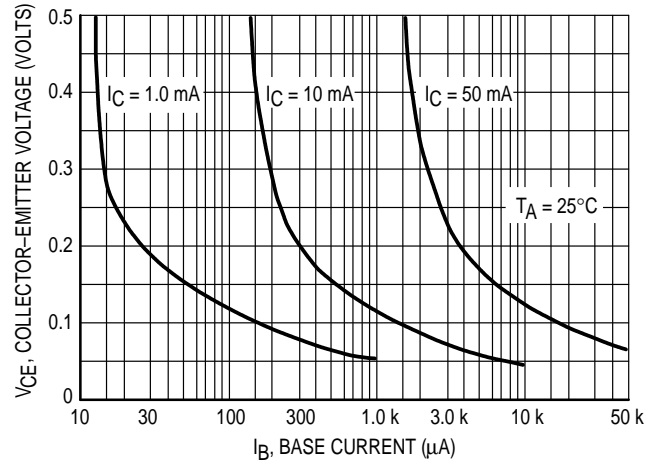

Figure 2. Collector Saturation Region

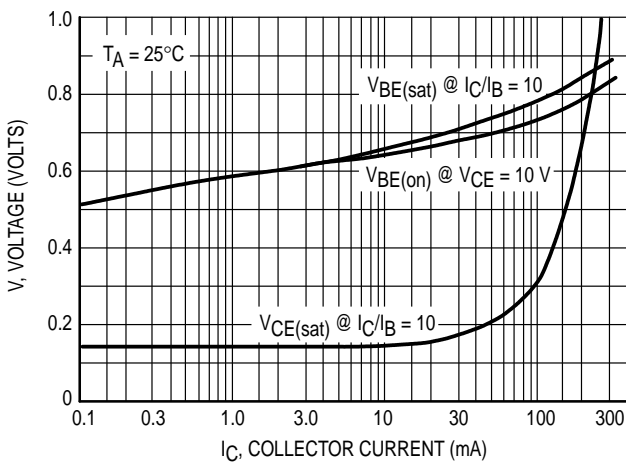

Figure 3. "On" Voltages

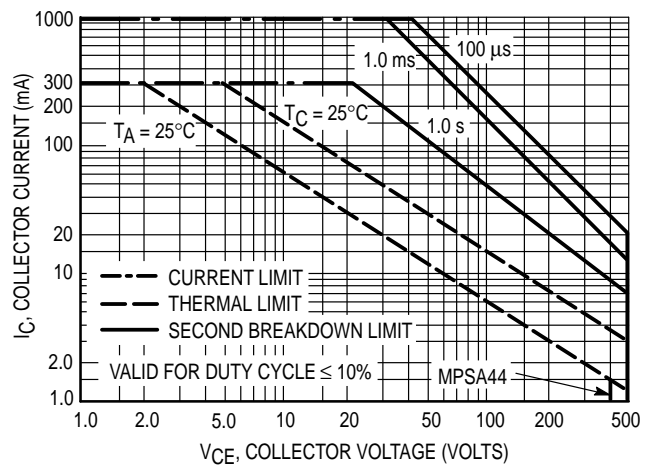

Figure 4. Active Region — Safe Operating Area

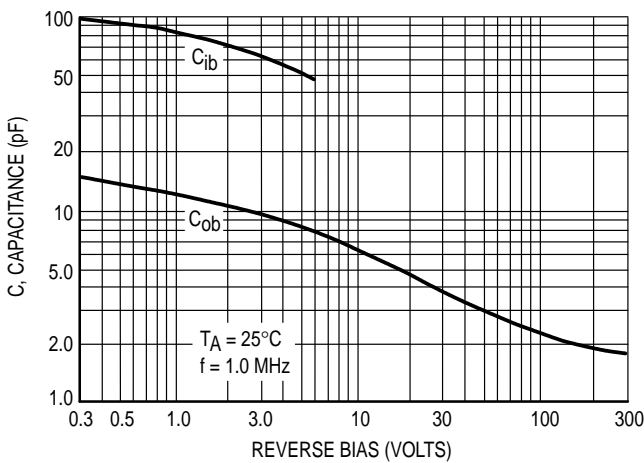

Figure 5. Capacitance

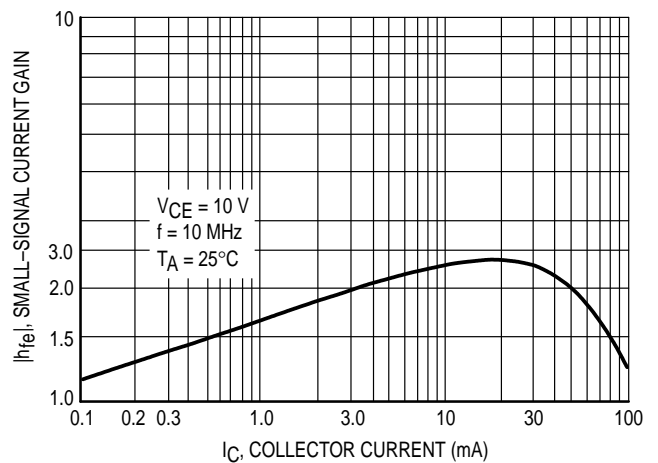

Figure 6. High Frequency Current Gain

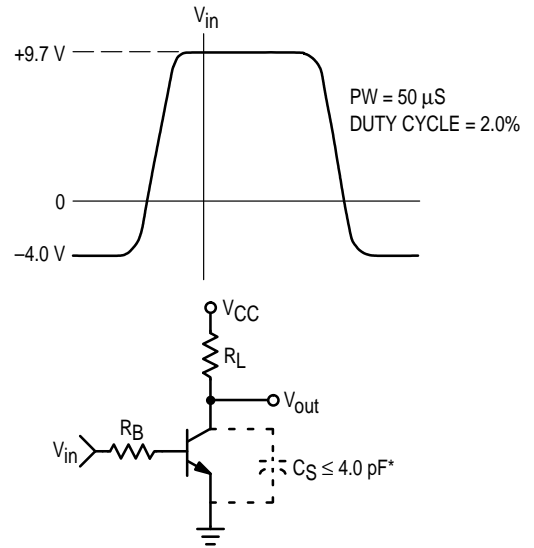
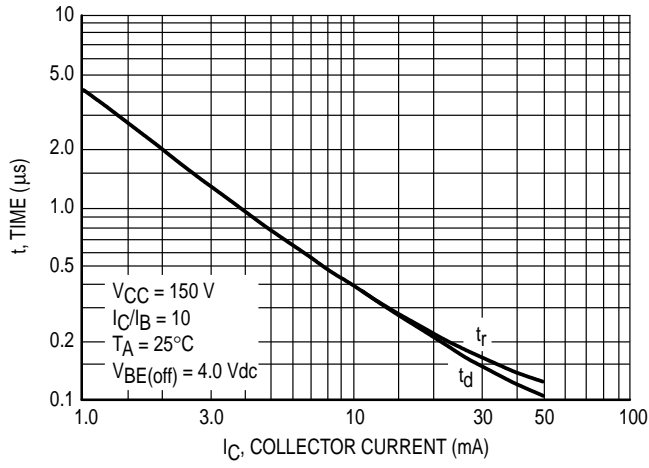

Figure 7. Turn-On Switching Times and Test Circuit

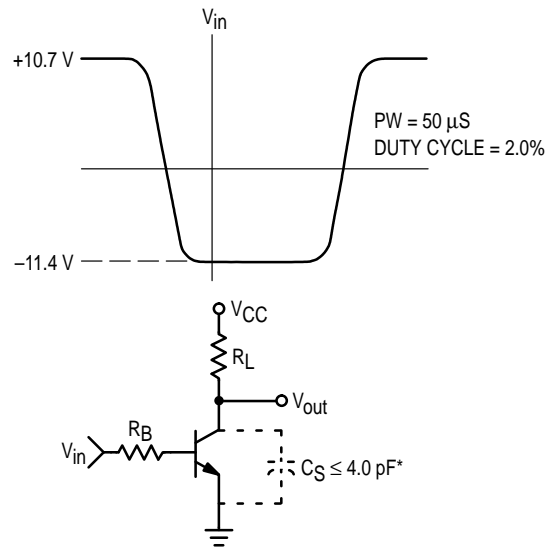
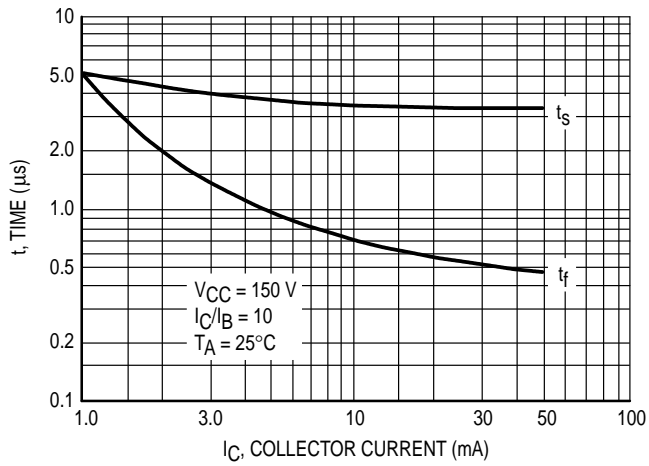
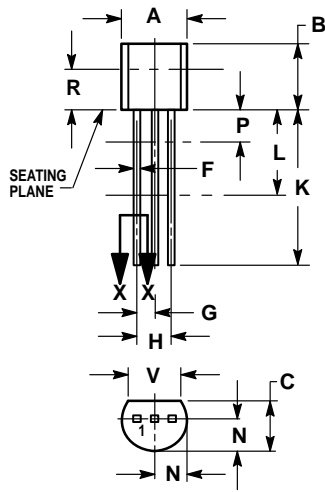

Figure 8. Turn-Off Switching Times and Test Circuit

\* Total Shunt Capacitance of Test Jig and Connectors.

PACKAGE DIMENSIONS



**CASE 029-04  
(TO-226AA)  
ISSUE AD**

- NOTES:
1. DIMENSIONING AND TOLERANCING PER ANSI Y14.5M, 1982.
  2. CONTROLLING DIMENSION: INCH.
  3. CONTOUR OF PACKAGE BEYOND DIMENSION R IS UNCONTROLLED.
  4. DIMENSION F APPLIES BETWEEN P AND L. DIMENSION D AND J APPLY BETWEEN L AND K. MINIMUM LEAD DIMENSION IS UNCONTROLLED IN P AND BEYOND DIMENSION K MINIMUM.

DIM	INCHES		MILLIMETERS	
	MIN	MAX	MIN	MAX
A	0.175	0.205	4.45	5.20
B	0.170	0.210	4.32	5.33
C	0.125	0.165	3.18	4.19
D	0.016	0.022	0.41	0.55
F	0.016	0.019	0.41	0.48
G	0.045	0.055	1.15	1.39
H	0.095	0.105	2.42	2.66
J	0.015	0.020	0.39	0.50
K	0.500	—	12.70	—
L	0.250	—	6.35	—
N	0.080	0.105	2.04	2.66
P	—	0.100	—	2.54
R	0.115	—	2.93	—
V	0.135	—	3.43	—

- STYLE 1:  
 PIN 1. EMITTER  
 2. BASE  
 3. COLLECTOR

Motorola reserves the right to make changes without further notice to any products herein. Motorola makes no warranty, representation or guarantee regarding the suitability of its products for any particular purpose, nor does Motorola assume any liability arising out of the application or use of any product or circuit, and specifically disclaims any and all liability, including without limitation consequential or incidental damages. "Typical" parameters which may be provided in Motorola data sheets and/or specifications can and do vary in different applications and actual performance may vary over time. All operating parameters, including "Typicals" must be validated for each customer application by customer's technical experts. Motorola does not convey any license under its patent rights nor the rights of others. Motorola products are not designed, intended, or authorized for use as components in systems intended for surgical implant into the body, or other applications intended to support or sustain life, or for any other application in which the failure of the Motorola product could create a situation where personal injury or death may occur. Should Buyer purchase or use Motorola products for any such unintended or unauthorized application, Buyer shall indemnify and hold Motorola and its officers, employees, subsidiaries, affiliates, and distributors harmless against all claims, costs, damages, and expenses, and reasonable attorney fees arising out of, directly or indirectly, any claim of personal injury or death associated with such unintended or unauthorized use, even if such claim alleges that Motorola was negligent regarding the design or manufacture of the part. Motorola and  are registered trademarks of Motorola, Inc. Motorola, Inc. is an Equal Opportunity/Affirmative Action Employer.

**How to reach us:**

**USA/EUROPE/Locations Not Listed:** Motorola Literature Distribution;  
P.O. Box 20912; Phoenix, Arizona 85036. 1-800-441-2447 or 602-303-5454

**MFAX:** RMFAX0@email.sps.mot.com – TOUCHTONE 602-244-6609  
**INTERNET:** <http://Design-NET.com>

**JAPAN:** Nippon Motorola Ltd.; Tatsumi-SPD-JLDC, 6F Seibu-Butsuryu-Center,  
3-14-2 Tatsumi Koto-Ku, Tokyo 135, Japan. 03-81-3521-8315

**ASIA/PACIFIC:** Motorola Semiconductors H.K. Ltd.; 8B Tai Ping Industrial Park,  
51 Ting Kok Road, Tai Po, N.T., Hong Kong. 852-26629298

**MOTOROLA****MPSA44/D**