



MOTOROLA

**MC74AC299
MC74ACT299**

**8-INPUT UNIVERSAL
SHIFT/STORAGE REGISTER
WITH COMMON
PARALLEL I/O PINS**

**8-Input Universal
Shift/Storage Register
with Common Parallel I/O Pins**

The MC74AC299/74ACT299 is an 8-bit universal shift/storage register with 3-state outputs. Four modes of operation are possible: hold (store), shift left, shift right and load data. The parallel load inputs and flip-flop outputs are multiplexed to reduce the total number of package pins. Additional outputs are provided for flip-flops Q₀, Q₇ to allow easy serial cascading. A separate active LOW Master Reset is used to reset the register.

- Common Parallel I/O for Reduced Pin Count
- Additional Serial Inputs and Outputs for Expansion
- Four Operating Modes: Shift Left, Shift Right, Load and Store
- 3-State Outputs for Bus-Oriented Applications
- Outputs Source/Sink 24 mA
- 'ACT299 Has TTL Compatible Inputs

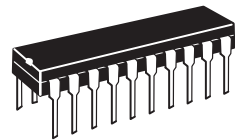

**N SUFFIX
CASE 738-03
PLASTIC**

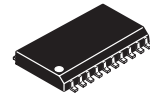

**DW SUFFIX
CASE 751D-04
PLASTIC**

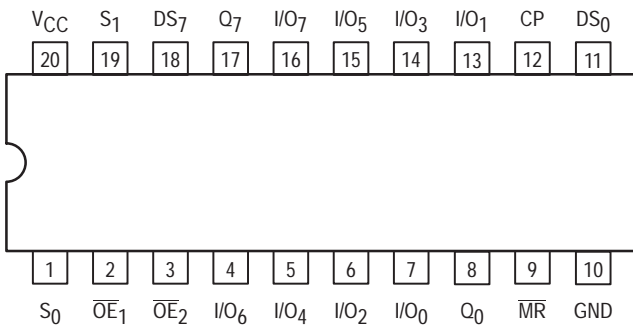

PIN NAMES

- | | |
|---------------------------------------|--|
| CP | Clock Pulse Input |
| DS ₀ | Serial Data Input for Right Shift |
| DS ₇ | Serial Data Input for Left Shift |
| S ₀ , S ₁ | Mode Select Inputs |
| \overline{MR} | Asynchronous Master Reset |
| \overline{OE}_1 , \overline{OE}_2 | 3-State Output Enable Inputs |
| I/O ₀ -I/O ₇ | Parallel Data Inputs or 3-State Parallel Outputs |
| Q ₀ , Q ₇ | Serial Outputs |

LOGIC SYMBOL

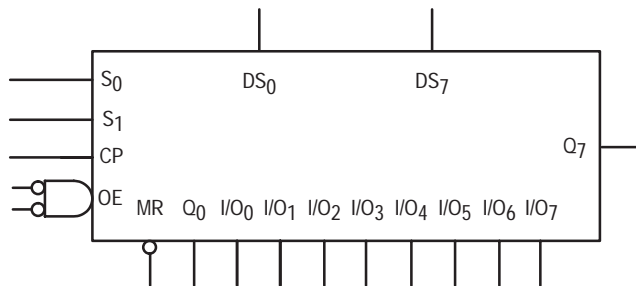

MC74AC299 MC74ACT299

LOGIC DIAGRAM

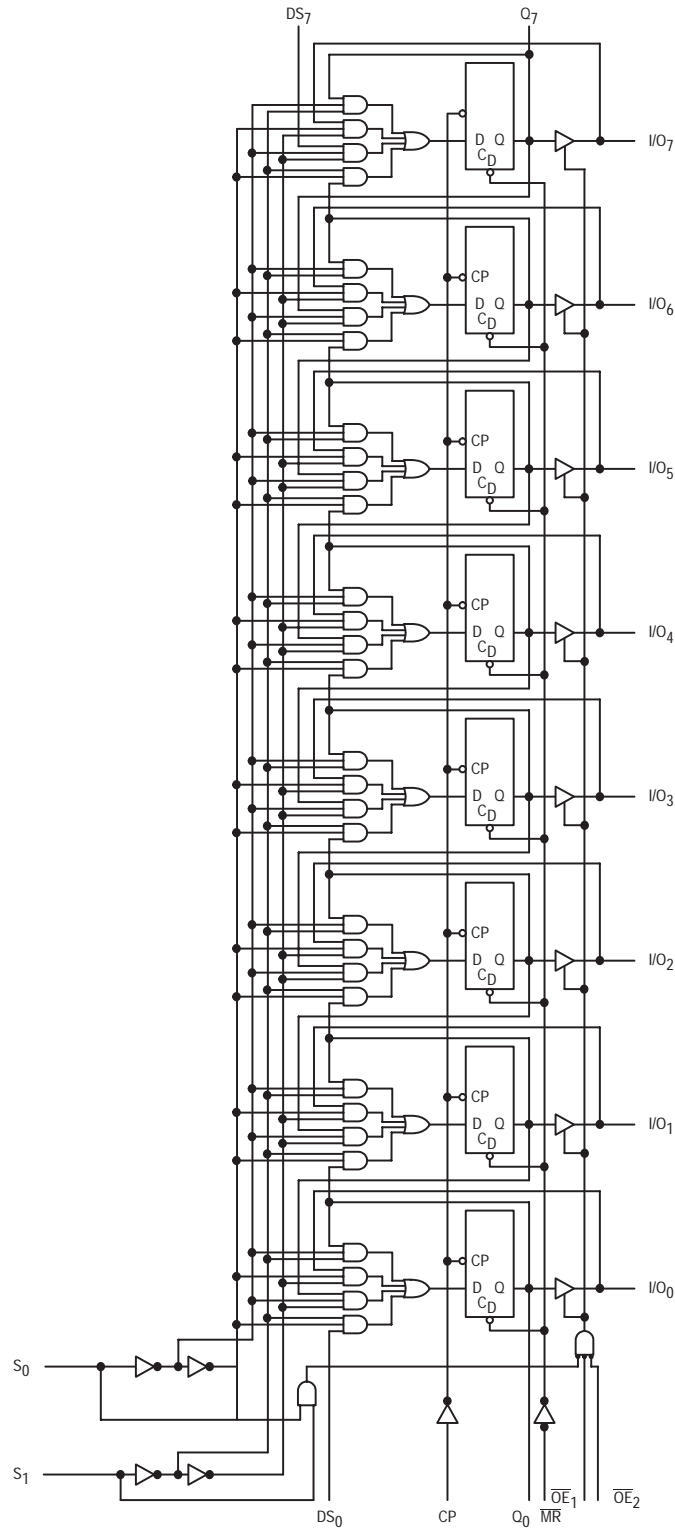

Please note that this diagram is provided only for the understanding of logic operations and should not be used to estimate propagation delays.

MC74AC299 MC74ACT299

FUNCTIONAL DESCRIPTION

The MC74AC299/74ACT299 contains eight edge-triggered D-type flip-flops and the interstage logic necessary to perform synchronous shift left, shift right, parallel load and hold operations. The type of operation is determined by S_0 and S_1 , as shown in the Truth Table. All flip-flop outputs are brought out through 3-state buffers to separate I/O pins that also serve as data inputs in the parallel load mode. Q_0 and Q_7 are also brought out on other pins for expansion in serial shifting of longer words.

A LOW signal on \overline{MR} overrides the Select and CP inputs and resets the flip-flops. All other state changes are initiated by the rising edge of the clock. Inputs can change when the clock is in either state provided only that the recommended setup and hold times, relative to the rising edge of CP, are observed.

A HIGH signal on either \overline{OE}_1 or \overline{OE}_2 disables the 3-state buffers and puts the I/O pins in the high impedance state. In this condition the shift, hold, load and reset operations can still occur. The 3-state buffers are also disabled by HIGH signals on both S_0 and S_1 in preparation for a parallel load operation.

TRUTH TABLE

Inputs				Response
\overline{MR}	S_1	S_0	CP	
L	X	X	X	Asynchronous Reset; Q_0 – Q_7 = LOW
H	H	H	\lrcorner	Parallel Load; I/O_n Q_n
H	L	H	\lrcorner	Shift Rights; DS_0 Q_0, Q_0 Q_1 , etc.
H	H	L	\lrcorner	Shift Left; DS_7 Q_7, Q_7 Q_6 , etc.
H	L	L	X	Hold

H = HIGH Voltage Level
 L = LOW Voltage Level
 X = Immaterial
 \lrcorner = LOW-to-HIGH Transition

MAXIMUM RATINGS*

Symbol	Parameter	Value	Unit
V_{CC}	DC Supply Voltage (Referenced to GND)	–0.5 to +7.0	V
V_{in}	DC Input Voltage (Referenced to GND)	–0.5 to V_{CC} +0.5	V
V_{out}	DC Output Voltage (Referenced to GND)	–0.5 to V_{CC} +0.5	V
I_{in}	DC Input Current, per Pin	± 20	mA
I_{out}	DC Output Sink/Source Current, per Pin	± 50	mA
I_{CC}	DC V_{CC} or GND Current per Output Pin	± 50	mA
T_{stg}	Storage Temperature	–65 to +150	$^{\circ}C$

* Maximum Ratings are those values beyond which damage to the device may occur. Functional operation should be restricted to the Recommended Operating Conditions.

RECOMMENDED OPERATING CONDITIONS

Symbol	Parameter	Min	Typ	Max	Unit	
V_{CC}	Supply Voltage	'AC	2.0	5.0	6.0	V
		'ACT	4.5	5.0	5.5	
V_{in}, V_{out}	DC Input Voltage, Output Voltage (Ref. to GND)	0		V_{CC}	V	
t_r, t_f	Input Rise and Fall Time (Note 1) 'AC Devices except Schmitt Inputs	V_{CC} @ 3.0 V		150	ns/V	
		V_{CC} @ 4.5 V		40		
		V_{CC} @ 5.5 V		25		
t_r, t_f	Input Rise and Fall Time (Note 2) 'ACT Devices except Schmitt Inputs	V_{CC} @ 4.5 V		10	ns/V	
		V_{CC} @ 5.5 V		8.0		
T_J	Junction Temperature (PDIP)			140	$^{\circ}C$	
T_A	Operating Ambient Temperature Range	–40	25	85	$^{\circ}C$	
I_{OH}	Output Current — High			–24	mA	
I_{OL}	Output Current — Low			24	mA	

- V_{in} from 30% to 70% V_{CC} ; see individual Data Sheets for devices that differ from the typical input rise and fall times.
- V_{in} from 0.8 V to 2.0 V; see individual Data Sheets for devices that differ from the typical input rise and fall times.

MC74AC299 MC74ACT299

DC CHARACTERISTICS

Symbol	Parameter	V _{CC} (V)	74AC		74AC		Unit	Conditions
			T _A = +25°C		T _A = -40°C to +85°C			
			Typ	Guaranteed Limits				
V _{IH}	Minimum High Level Input Voltage	3.0	1.5	2.1	2.1	V	V _{OUT} = 0.1 V or V _{CC} - 0.1 V	
		4.5	2.25	3.15	3.15			
		5.5	2.75	3.85	3.85			
V _{IL}	Maximum Low Level Input Voltage	3.0	1.5	0.9	0.9	V	V _{OUT} = 0.1 V or V _{CC} - 0.1 V	
		4.5	2.25	1.35	1.35			
		5.5	2.75	1.65	1.65			
V _{OH}	Minimum High Level Output Voltage	3.0	2.99	2.9	2.9	V	I _{OUT} = -50 μA	
		4.5	4.49	4.4	4.4			
		5.5	5.49	5.4	5.4			
		3.0		2.56	2.46	V	*V _{IN} = V _{IL} or V _{IH} -12 mA I _{OH} -24 mA -24 mA	
		4.5		3.86	3.76			
		5.5		4.86	4.76			
V _{OL}	Maximum Low Level Output Voltage	3.0	0.002	0.1	0.1	V	I _{OUT} = 50 μA	
		4.5	0.001	0.1	0.1			
		5.5	0.001	0.1	0.1			
		3.0		0.36	0.44	V	*V _{IN} = V _{IL} or V _{IH} 12 mA I _{OL} 24 mA 24 mA	
		4.5		0.36	0.44			
		5.5		0.36	0.44			
I _{IN}	Maximum Input Leakage Current	5.5		±0.1	±1.0	μA	V _I = V _{CC} , GND	
I _{OZT}	Maximum 3-State Current	5.5		±0.6	±6.0	μA	V _I (OE) = V _{IL} , V _{IH} V _I = V _{CC} , GND V _O = V _{CC} , GND	
I _{OLD}	†Minimum Dynamic Output Current	5.5			75	mA	V _{OLD} = 1.65 V Max	
I _{OHD}		5.5			-75	mA	V _{OHD} = 3.85 V Min	
I _{CC}	Maximum Quiescent Supply Current	5.5		8.0	80	μA	V _{IN} = V _{CC} or GND	

* All outputs loaded; thresholds on input associated with output under test.

† Maximum test duration 2.0 ms, one output loaded at a time.

Note: I_{IN} and I_{CC} @ 3.0 V are guaranteed to be less than or equal to the respective limit @ 5.5 V V_{CC}.

MC74AC299 MC74ACT299

AC CHARACTERISTICS (For Figures and Waveforms — See Section 3)

Symbol	Parameter	V _{CC} * (V)	74AC			74AC		Unit	Fig. No.
			T _A = +25°C C _L = 50 pF			T _A = -40°C to +85°C C _L = 50 pF			
			Min	Typ	Max	Min	Max		
f _{max}	Maximum Input Frequency	3.3 5.0	90 130			80 105		MHz	3-3
t _{PLH}	Propagation Delay CP to Q ₀ or Q ₇	3.3 5.0	8.5 5.5		20.5 14	7.0 4.5	22 15	ns	3-6
t _{PHL}	Propagation Delay CP to Q ₀ or Q ₇	3.3 5.0	8.5 5.5		21.5 14.5	7.0 5.0	23 16	ns	3-6
t _{PLH}	Propagation Delay CP to I/O _n	3.3 5.0	9.0 6.0		20.5 14.5	7.5 5.0	22.5 16	ns	3-6
t _{PHL}	Propagation Delay CP to I/O _n	3.3 5.0	10 6.5		23 16	8.5 6.0	24.5 17.5	ns	3-6
t _{PHL}	Propagation Delay MR to Q ₀ or Q ₇	3.3 5.0	9.0 5.5		22.5 15.5	7.5 5.0	25.0 17.0	ns	3-6
t _{PHL}	Propagation Delay MR to I/O _n	3.3 5.0	9.0 5.5		21.5 15.0	7.5 5.0	24.0 16.5	ns	3-6
t _{PZH}	Output Enable Time OE to I/O _n	3.3 5.0	7.0 4.5		18 12.5	6.0 4.0	19.5 13.5	ns	3-7
t _{PZL}	Output Enable Time OE to I/O _n	3.3 5.0	7.0 5.0		18 12.5	6.0 4.0	20.5 14	ns	3-8
t _{PHZ}	Output Disable Time OE to I/O _n	3.3 5.0	6.5 3.5		18.5 14	5.5 3.0	19.5 15	ns	3-7
t _{PLZ}	Output Disable Time OE to I/O _n	3.3 5.0	5.5 3.5		17 12.5	4.5 2.0	19 13.5	ns	3-8

* Voltage Range 3.3 V is 3.3 V ±0.3 V.
Voltage Range 5.0 V is 5.0 V ±0.5 V.

MC74AC299 MC74ACT299

AC OPERATING REQUIREMENTS

Symbol	Parameter	V _{CC} * (V)	74AC		Unit	Fig. No.
			74AC			
			T _A = +25°C C _L = 50 pF	T _A = -40°C to +85°C C _L = 50 pF		
Typ	Guaranteed Minimum					
t _s	Setup Time, HIGH or LOW S ₀ or S ₁ to CP	3.3	8.0	8.5	ns	3-9
		5.0	5.0	5.5		
t _h	Hold Time, HIGH or LOW S ₀ or S ₁ to CP	3.3	0.5	0.5	ns	3-9
		5.0	1.0	1.0		
t _s	Setup Time, HIGH or LOW I/O _n to CP	3.3	5.5	6.0	ns	3-9
		5.0	3.5	4.0		
t _h	Hold Time, HIGH or LOW I/O _n to CP	3.3	0	0	ns	3-9
		5.0	1.0	1.0		
t _s	Setup Time, HIGH or LOW DS ₀ or DS ₇ to CP	3.3	6.5	7.0	ns	3-6
		5.0	4.0	4.5		
t _h	Hold Time, HIGH or LOW DS ₀ or DS ₇ to CP	3.3	0	0.5	ns	3-6
		5.0	1.0	1.0		
t _w	CP Pulse Width, LOW	3.3	4.5	5.0	ns	3-6
		5.0	3.5	3.5		
t _w	$\overline{\text{MR}}$ Pulse Width, LOW	3.3	4.5	5.0	ns	3-9
		5.0	3.5	3.5		
t _{rec}	Recovery Time $\overline{\text{MR}}$ to CP	3.3	1.5	1.5	ns	3-9
		5.0	1.5	1.5		

* Voltage Range 3.3 V is 3.3 V ±0.3 V.
Voltage Range 5.0 V is 5.0 V ±0.5 V.

MC74AC299 MC74ACT299

DC CHARACTERISTICS

Symbol	Parameter	V _{CC} (V)	74ACT		74ACT		Unit	Conditions
			T _A = +25°C		T _A = -40°C to +85°C			
			Typ	Guaranteed Limits				
V _{IH}	Minimum High Level Input Voltage	4.5	1.5	2.0	2.0	V	V _{OUT} = 0.1 V or V _{CC} - 0.1 V	
		5.5	1.5	2.0	2.0			
V _{IL}	Maximum Low Level Input Voltage	4.5	1.5	0.8	0.8	V	V _{OUT} = 0.1 V or V _{CC} - 0.1 V	
		5.5	1.5	0.8	0.8			
V _{OH}	Minimum High Level Output Voltage	4.5	4.49	4.4	4.4	V	I _{OUT} = -50 μA	
		5.5	5.49	5.4	5.4			
		4.5		3.86	3.76	V	*V _{IN} = V _{IL} or V _{IH} -24 mA	
		5.5		4.86	4.76		I _{OH} -24 mA	
V _{OL}	Maximum Low Level Output Voltage	4.5	0.001	0.1	0.1	V	I _{OUT} = 50 μA	
		5.5	0.001	0.1	0.1			
		4.5		0.36	0.44	V	*V _{IN} = V _{IL} or V _{IH} 24 mA	
		5.5		0.36	0.44		I _{OL} 24 mA	
I _{IN}	Maximum Input Leakage Current	5.5		±0.1	±1.0	μA	V _I = V _{CC} , GND	
I _{OZT}	Maximum 3-State Current	5.5		±0.6	±6.0	μA	V _I (OE) = V _{IL} , V _{IH} V _I = V _{CC} , GND V _O = V _{CC} , GND	
ΔI _{CCT}	Additional Max. I _{CC} /Input	5.5	0.6		1.5	mA	V _I = V _{CC} - 2.1 V	
I _{OLD}	†Minimum Dynamic Output Current	5.5			75	mA	V _{OLD} = 1.65 V Max	
I _{OHD}		5.5			-75	mA	V _{OHD} = 3.85 V Min	
I _{CC}	Maximum Quiescent Supply Current	5.5		8.0	80	μA	V _{IN} = V _{CC} or GND	

* All outputs loaded; thresholds on input associated with output under test.

† Maximum test duration 2.0 ms, one output loaded at a time.

MC74AC299 MC74ACT299

AC CHARACTERISTICS (For Figures and Waveforms — See Section 3)

Symbol	Parameter	V _{CC} * (V)	74ACT			74ACT		Unit	Fig. No.
			T _A = +25°C C _L = 50 pF			T _A = -40°C to +85°C C _L = 50 pF			
			Min	Typ	Max	Min	Max		
f _{max}	Maximum Input Frequency	5.0	120			110		MHz	3-3
t _{PLH}	Propagation Delay CP to Q ₀ or Q ₇	5.0	4.0		12.5	3.0	14	ns	3-6
t _{PHL}	Propagation Delay CP to Q ₀ or Q ₇	5.0	4.0		13.5	3.5	15	ns	3-6
t _{PLH}	Propagation Delay CP to I/O _n	5.0	4.5		12.5	4.5	13.5	ns	3-6
t _{PHL}	Propagation Delay CP to I/O _n	5.0	5.0		15	4.5	16.5	ns	3-6
t _{PHL}	Propagation Delay MR to Q ₀ or Q ₇	5.0	4.0		15	4.0	18	ns	3-6
t _{PHL}	Propagation Delay MR to I/O _n	5.0	4.0		14.5	3.5	17.5	ns	3-6
t _{PZH}	Output Enable Time OE to I/O _n	5.0	2.5		12	1.5	13	ns	3-7
t _{PZL}	Output Enable Time OE to I/O _n	5.0	2.0		12	1.5	13.5	ns	3-8
t _{PHZ}	Output Disable Time OE to I/O _n	5.0	2.0		12.5	2.0	13.5	ns	3-7
t _{PLZ}	Output Disable Time OE to I/O _n	5.0	2.5		11.5	2.0	12.5	ns	3-8

* Voltage Range 5.0 V is 5.0 V ±0.5 V.

MC74AC299 MC74ACT299

AC OPERATING REQUIREMENTS

Symbol	Parameter	V _{CC} * (V)	74ACT		Unit	Fig. No.	
			T _A = +25°C C _L = 50 pF				T _A = -40°C to +85°C C _L = 50 pF
			Typ	Guaranteed Minimum			
t _s	Setup Time, HIGH or LOW S ₀ or S ₁ to CP	5.0		5.0	5.5	ns	3-9
t _h	Hold Time, HIGH or LOW S ₀ or S ₁ to CP	5.0		1.0	1.0	ns	3-9
t _s	Setup Time, HIGH or LOW I/O _n to CP	5.0		4.0	4.5	ns	3-9
t _h	Hold Time, HIGH or LOW I/O _n to CP	5.0		1.0	1.0	ns	3-9
t _s	Setup Time, HIGH or LOW DS ₀ or DS ₇ to CP	5.0		4.5	5.0	ns	3-6
t _h	Hold Time, HIGH or LOW DS ₀ or DS ₇ to CP	5.0		1.0	1.0	ns	3-6
t _w	CP Pulse Width HIGH or LOW	5.0		4.0	4.5	ns	3-9
t _w	$\overline{\text{MR}}$ Pulse Width, LOW	5.0		3.5	3.5	ns	3-9
t _{rec}	Recovery Time $\overline{\text{MR}}$ to CP	5.0		1.5	1.5	ns	3-9

* Voltage Range 5.0 V is 5.0 V ±0.5 V.

CAPACITANCE

Symbol	Parameter	Value Typ	Unit	Test Conditions
C _{IN}	Input Capacitance	4.5	pF	V _{CC} = 5.0 V
C _{PD}	Power Dissipation Capacitance	170	pF	V _{CC} = 5.0 V

MC74AC299 MC74ACT299

OUTLINE DIMENSIONS

N SUFFIX PLASTIC DIP PACKAGE CASE 738-03 ISSUE E

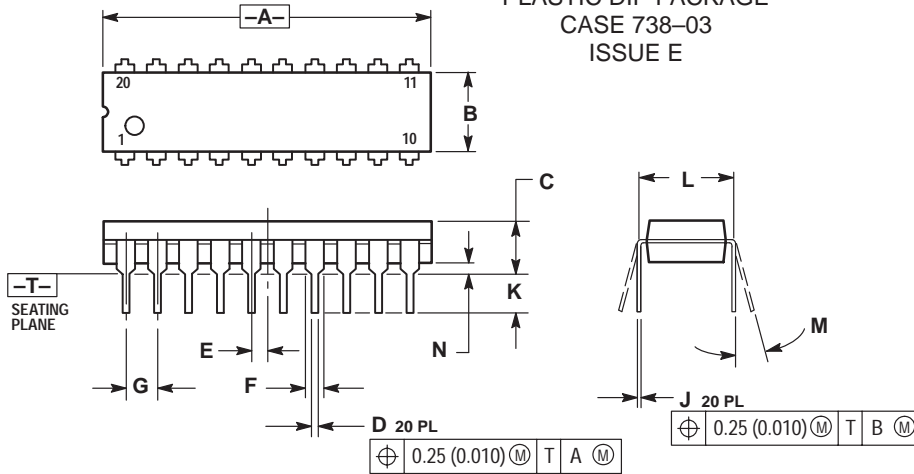

- NOTES:
1. DIMENSIONING AND TOLERANCING PER ANSI Y14.5M, 1982.
 2. CONTROLLING DIMENSION: INCH.
 3. DIMENSION L TO CENTER OF LEAD WHEN FORMED PARALLEL.
 4. DIMENSION B DOES NOT INCLUDE MOLD FLASH.

DIM	INCHES		MILLIMETERS	
	MIN	MAX	MIN	MAX
A	1.010	1.070	25.66	27.17
B	0.240	0.260	6.10	6.60
C	0.150	0.180	3.81	4.57
D	0.015	0.022	0.39	0.55
E	0.050 BSC		1.27 BSC	
F	0.050	0.070	1.27	1.77
G	0.100 BSC		2.54 BSC	
J	0.008	0.015	0.21	0.38
K	0.110	0.140	2.80	3.55
L	0.300 BSC		7.62 BSC	
M	0°	15°	0°	15°
N	0.020	0.040	0.51	1.01

DW SUFFIX PLASTIC SOIC PACKAGE CASE 751D-04 ISSUE E

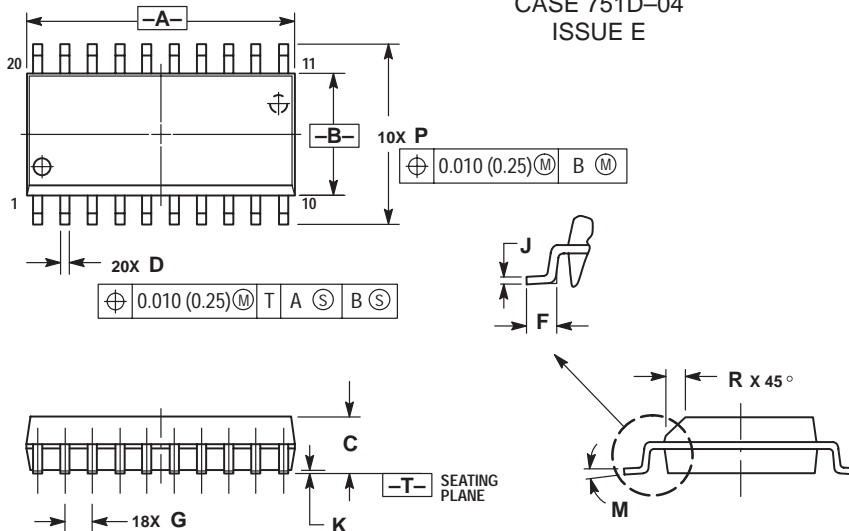

- NOTES:
1. DIMENSIONING AND TOLERANCING PER ANSI Y14.5M, 1982.
 2. CONTROLLING DIMENSION: MILLIMETER.
 3. DIMENSIONS A AND B DO NOT INCLUDE MOLD PROTRUSION.
 4. MAXIMUM MOLD PROTRUSION 0.150 (0.006) PER SIDE.
 5. DIMENSION D DOES NOT INCLUDE DAMBAR PROTRUSION. ALLOWABLE DAMBAR PROTRUSION SHALL BE 0.13 (0.005) TOTAL IN EXCESS OF D DIMENSION AT MAXIMUM MATERIAL CONDITION.

DIM	MILLIMETERS		INCHES	
	MIN	MAX	MIN	MAX
A	12.65	12.95	0.499	0.510
B	7.40	7.60	0.292	0.299
C	2.35	2.65	0.093	0.104
D	0.35	0.49	0.014	0.019
F	0.50	0.90	0.020	0.035
G	1.27 BSC		0.050 BSC	
J	0.25	0.32	0.010	0.012
K	0.10	0.25	0.004	0.009
M	0°	7°	0°	7°
P	10.05	10.55	0.395	0.415
R	0.25	0.75	0.010	0.029

Motorola reserves the right to make changes without further notice to any products herein. Motorola makes no warranty, representation or guarantee regarding the suitability of its products for any particular purpose, nor does Motorola assume any liability arising out of the application or use of any product or circuit, and specifically disclaims any and all liability, including without limitation consequential or incidental damages. "Typical" parameters can and do vary in different applications. All operating parameters, including "Typicals" must be validated for each customer application by customer's technical experts. Motorola does not convey any license under its patent rights nor the rights of others. Motorola products are not designed, intended, or authorized for use as components in systems intended for surgical implant into the body, or other applications intended to support or sustain life, or for any other application in which the failure of the Motorola product could create a situation where personal injury or death may occur. Should Buyer purchase or use Motorola products for any such unintended or unauthorized application, Buyer shall indemnify and hold Motorola and its officers, employees, subsidiaries, affiliates, and distributors harmless against all claims, costs, damages, and expenses, and reasonable attorney fees arising out of, directly or indirectly, any claim of personal injury or death associated with such unintended or unauthorized use, even if such claim alleges that Motorola was negligent regarding the design or manufacture of the part. Motorola and $\text{\textcircled{M}}$ are registered trademarks of Motorola, Inc. Motorola, Inc. is an Equal Opportunity/Affirmative Action Employer.

How to reach us:

USA/EUROPE: Motorola Literature Distribution;
P.O. Box 20912; Phoenix, Arizona 85036. 1-800-441-2447

JAPAN: Nippon Motorola Ltd.; Tatsumi-SPD-JLDC, Toshikatsu Otsuka,
6F Seibu-Butsuryu-Center, 3-14-2 Tatsumi Koto-Ku, Tokyo 135, Japan. 03-3521-8315

MFAX: RMFAX0@email.sps.mot.com -TOUCHTONE (602) 244-6609
INTERNET: <http://Design-NET.com>

HONG KONG: Motorola Semiconductors H.K. Ltd.; 8B Tai Ping Industrial Park,
51 Ting Kok Road, Tai Po, N.T., Hong Kong. 852-26629298



MC74AC299/D

