

*Product Preview*  
**Unbuffered Inverter**

**MC74HC1GU04**

The MC74HC1GU04 is a high speed CMOS unbuffered inverter fabricated with silicon gate CMOS technology. It achieves high speed operation similar to equivalent LSTTL while maintaining CMOS low power dissipation.

The internal circuit is composed of three stages, including a buffer output which provides high noise immunity and stable output.

The MC74HC1GU04 output drive current is 1/2 compared to MC74HC series.

- High Speed:  $t_{pD} = 7\text{ns}$  (Typ) at  $V_{CC} = 5\text{V}$
- Low Power Dissipation:  $I_{CC} = 1\mu\text{A}$  (Max) at  $T_A = 25^\circ\text{C}$
- High Noise Immunity
- Balanced Propagation Delays ( $t_{pLH} = t_{pHL}$ )
- Output Drive Capability: 5 LSTTL
- Symmetrical Output Impedance ( $I_{OH} = I_{OL} = 2\text{mA}$ )
- ESD Performance: HBM > 2000V; MM > 200V



**DF SUFFIX**  
5-LEAD SOT-353 PACKAGE  
SC-88A  
CASE 419A-01



**DT SUFFIX**  
5-LEAD TSSOP PACKAGE  
TSOP5  
CASE TBD

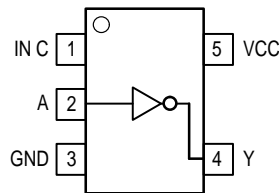

Figure 1. Pinout (Top View)

**FUNCTION TABLE**

Inputs	Outputs
L	H
H	L

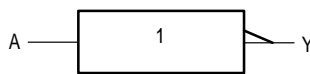
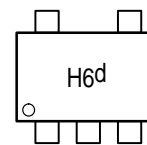

Figure 2. Logic Symbol



Pin 1  
d = Date Code

Marking Diagram

**DEVICE ORDERING INFORMATION**

Device Order Number	Device Nomenclature						Package Type	Tape and Reel Size
	Motorola Circuit Indicator	Temp Range Identifier	Technology	Device Function	Package Suffix	Tape and Reel Suffix		
MC74HC1GU04DFT1	MC	74	HC1G	U04	DF	T1	SC-88A	7-Inch/3000 Unit
MC74HC1GU04DTT1	MC	74	HC1G	U04	DT	T1	TSOP5	7-Inch/3000 Unit

This document contains information on a product under development. Motorola reserves the right to change or discontinue this product without notice.

**MAXIMUM RATINGS\***

Characteristics	Symbol	Value	Unit
DC Supply Voltage	$V_{CC}$	-0.5 to +7.0	V
DC Input Voltage	$V_{IN}$	-0.5 to $V_{CC} + 0.5$	V
DC Output Voltage	$V_{OUT}$	-0.5 to $V_{CC} + 0.5$	V
Input Diode Current	$I_{IK}$	$\pm 20$	mA
Output Diode Current ( $V_{OUT} < GND$ ; $V_{OUT} > V_{CC}$ )	$I_{OK}$	$\pm 20$	mA
DC Output Current, per Pin	$I_{OUT}$	$\pm 12.5$	mA
DC Supply Current, $V_{CC}$ and GND	$I_{CC}$	$\pm 25$	mA
Power dissipation in still air	$P_D$	200 450	mW
		SC-88A† TSOP5†	
Lead temperature, 1 mm from case for 10 s	$T_L$	260	°C
Storage temperature	$T_{stg}$	-65 to +150	°C

\* Maximum Ratings are those values beyond which damage to the device may occur. Exposure to these conditions or conditions beyond those indicated may adversely affect device reliability. Functional operation under absolute-maximum-rated conditions is not implied. Functional operation should be restricted to the Recommended Operating Conditions.

†Derating — SC-88A Package: -3 mW/°C from 65° to 125°C  
 — TSOP5 Package: -6 mW/°C from 65° to 125°C

**RECOMMENDED OPERATING CONDITIONS**

Characteristics	Symbol	Min	Max	Unit
DC Supply Voltage	$V_{CC}$	2.0	6.0	V
DC Input Voltage	$V_{IN}$	0.0	$V_{CC}$	V
DC Output Voltage	$V_{OUT}$	0.0	$V_{CC}$	V
Operating Temperature Range	$T_A$	-55	+125	°C
Input Rise and Fall Time	$t_r, t_f$	0	1000	ns
		$V_{CC} = 2.0V$	0	600
		$V_{CC} = 3.0V$	0	500
		$V_{CC} = 4.5V$	0	400
		$V_{CC} = 6.0V$	0	

## DC ELECTRICAL CHARACTERISTICS

Symbol	Parameter	Test Conditions	V <sub>CC</sub> (V)	T <sub>A</sub> = 25°C			T <sub>A</sub> ≤ 85°C		T <sub>A</sub> ≤ 125°C		Unit
				Min	Typ	Max	Min	Max	Min	Max	
V <sub>IH</sub>	Minimum High-Level Input Voltage		2.0	1.7			1.7		1.7		V
			3.0	2.45			2.45		2.45		
			4.5	3.60			3.60		3.60		
			6.0	4.80			4.80		4.80		
V <sub>IL</sub>	Maximum Low-Level Input Voltage		2.0			0.3		0.3		0.3	V
			3.0			0.5		0.5		0.5	
			4.5			0.9		0.9		0.9	
			6.0			1.20		1.20		1.20	
V <sub>OH</sub>	Minimum High-Level Output Voltage V <sub>IN</sub> = V <sub>IH</sub> or V <sub>IL</sub>	V <sub>IN</sub> = V <sub>IH</sub> or V <sub>IL</sub> I <sub>OH</sub> = -20μA	2.0	1.8	2.0		1.8		1.8		V
			3.0	2.7	3.0		2.7		2.7		
			4.5	4.0	4.5		4.0		4.0		
		V <sub>IN</sub> = V <sub>IH</sub> or V <sub>IL</sub> I <sub>OH</sub> = -2mA I <sub>OH</sub> = -2.6mA	4.5	4.18	4.33		4.13		4.08		V
			6.0	5.68	5.76		5.63		5.58		
V <sub>OL</sub>	Maximum Low-Level Output Voltage V <sub>IN</sub> = V <sub>IH</sub> or V <sub>IL</sub>	V <sub>IN</sub> = V <sub>IH</sub> or V <sub>IL</sub> I <sub>OL</sub> = 20μA	2.0		0.0	0.1		0.1		0.1	V
			3.0		0.0	0.1		0.1		0.1	
			4.5		0.0	0.1		0.1		0.1	
		V <sub>IN</sub> = V <sub>IH</sub> or V <sub>IL</sub> I <sub>OL</sub> = 2mA I <sub>OL</sub> = 2.6mA	4.5			0.26		0.33		0.40	V
			6.0			0.26		0.33		0.40	
I <sub>IN</sub>	Maximum Input Leakage Current	V <sub>IN</sub> = 6.0V or GND	0 to 6.0			±0.1		±1.0		μA	
I <sub>CC</sub>	Maximum Quiescent Supply Current	V <sub>IN</sub> = V <sub>CC</sub> or GND	6.0			1.0		10		40 μA	

AC ELECTRICAL CHARACTERISTICS (C<sub>load</sub> = 50 pF, Input t<sub>r</sub> = t<sub>f</sub> = 6.0ns)

Symbol	Parameter	Test Conditions	T <sub>A</sub> = 25°C			T <sub>A</sub> ≤ 85°C		T <sub>A</sub> ≤ 125°C		Unit
			Min	Typ	Max	Min	Max	Min	Max	
t <sub>PLH</sub> , t <sub>PHL</sub>	Maximum Propagation Delay, Input A to Y	V <sub>CC</sub> = 5.0V    C <sub>L</sub> = 15 pF		7.0	15		20		25	ns
		V <sub>CC</sub> = 2.0V    C <sub>L</sub> = 50 pF		48	100		125		155	
			V <sub>CC</sub> = 3.0V	24	40		50		90	
			V <sub>CC</sub> = 4.5V	12	20		25		35	
V <sub>CC</sub> = 6.0V	9.0	17		21		26				
t <sub>TLH</sub> , t <sub>THL</sub>	Output Transition Time	V <sub>CC</sub> = 5.0V    C <sub>L</sub> = 15 pF		5.0	10		15		20	ns
		V <sub>CC</sub> = 2.0V    C <sub>L</sub> = 50 pF		50	125		155		200	
			V <sub>CC</sub> = 3.0V	22	35		45		60	
			V <sub>CC</sub> = 4.5V	14	25		31		38	
			V <sub>CC</sub> = 6.0V	12	21		26		32	
C <sub>IN</sub>	Maximum Input Capacitance		5	10		10		10	pF	

CPD	Power Dissipation Capacitance (Note 1.)	Typical @ 25°C, V <sub>CC</sub> = 5.0V	
		Min	Max
		10	

1. CPD is defined as the value of the internal equivalent capacitance which is calculated from the operating current consumption without load. Average operating current can be obtained by the equation: I<sub>CC(OPR)</sub> = CPD • V<sub>CC</sub> • f<sub>in</sub> + I<sub>CC</sub>. CPD is used to determine the no-load dynamic power consumption; P<sub>D</sub> = CPD • V<sub>CC</sub><sup>2</sup> • f<sub>in</sub> + I<sub>CC</sub> • V<sub>CC</sub>.

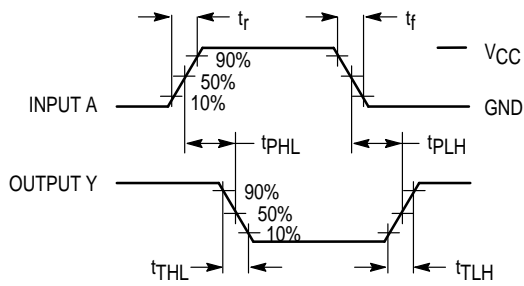
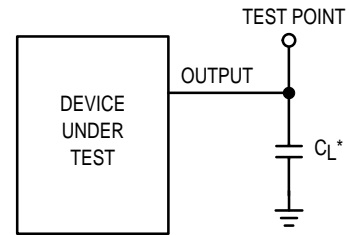

Figure 3. Switching Waveforms



\* Includes all probe and jig capacitance

Figure 4. Test Circuit

OUTLINE DIMENSIONS

DF SUFFIX  
5-LEAD SOT-353 PACKAGE  
SC-88A  
CASE 419A-01  
ISSUE B

- NOTES:  
1. DIMENSIONING AND TOLERANCING PER ANSI Y14.5M, 1982.  
2. CONTROLLING DIMENSION: MM.

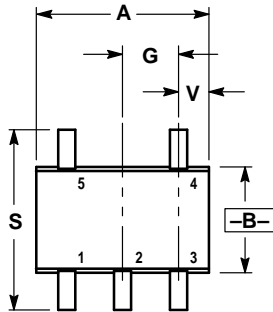

D 5 PL  $\oplus$  0.2 (0.008) M B M

DIM	INCHES		MILLIMETERS	
	MIN	MAX	MIN	MAX
A	0.071	0.087	1.80	2.20
B	0.045	0.053	1.15	1.35
C	0.031	0.043	0.80	1.10
D	0.004	0.012	0.10	0.30
G	0.026 BSC		0.65 BSC	
H	—	0.004	—	0.10
J	0.004	0.010	0.10	0.25
K	0.004	0.012	0.10	0.30
N	0.008 REF		0.20 REF	
S	0.079	0.087	2.00	2.20
V	0.012	0.016	0.30	0.40

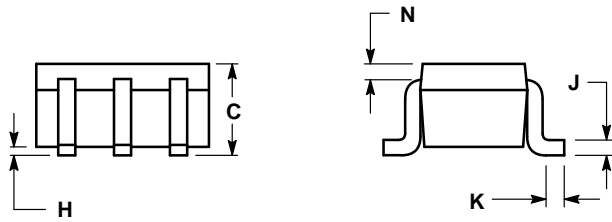

SOT-353

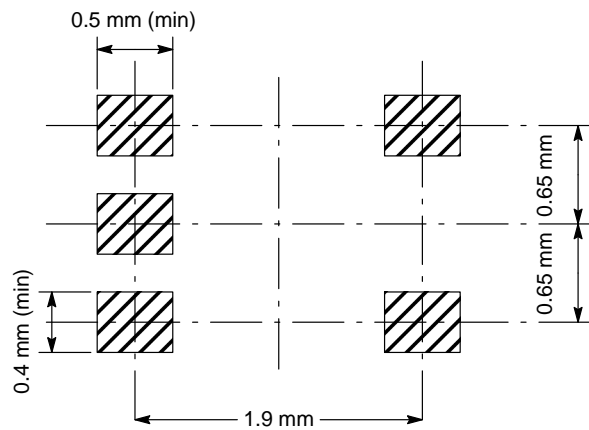

"T1" PIN ONE TOWARDS SPROCKET HOLE

SOT-353 (5 Pin) DEVICE

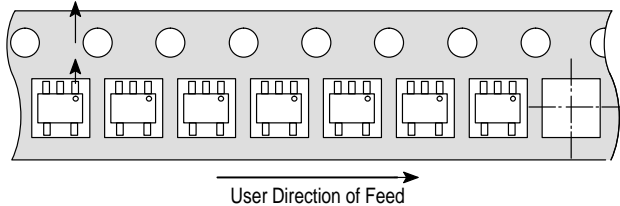

**PROPOSED DT SUFFIX**  
**5-LEAD TSSOP PACKAGE**  
 TSOP5  
 CASE TBD  
 ISSUE TBD

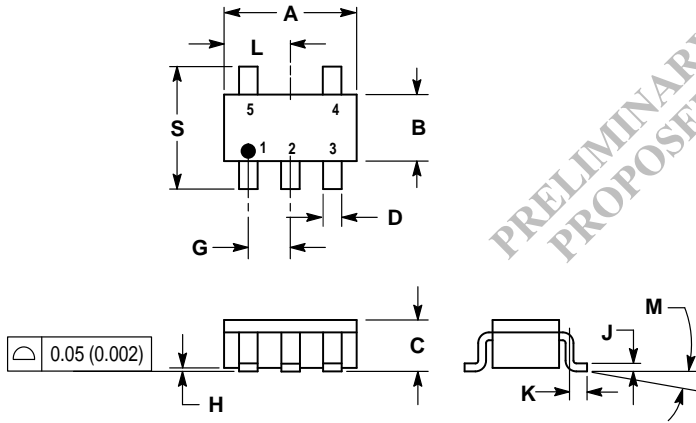

PRELIMINARY  
PROPOSED

- NOTES:
1. DIMENSIONING AND TOLERANCING PER ANSI Y14.5M, 1982.
  2. CONTROLLING DIMENSION: MILLIMETER.
  3. MAXIMUM LEAD THICKNESS INCLUDES LEAD FINISH THICKNESS. MINIMUM LEAD THICKNESS IS THE MINIMUM THICKNESS OF BASE MATERIAL.

DIM	MILLIMETERS		INCHES	
	MIN	MAX	MIN	MAX
A	2.90	3.10	0.1142	0.1220
B	1.30	1.70	0.0512	0.0669
C	0.90	1.10	0.0354	0.0433
D	0.25	0.50	0.0098	0.0197
G	0.85	1.05	0.0335	0.0413
H	0.013	0.100	0.0005	0.0040
J	0.10	0.26	0.0040	0.0102
K	0.20	0.60	0.0079	0.0236
L	1.25	1.55	0.0493	0.0610
M	0°	10°	0°	10°
S	2.50	3.00	0.0985	0.1181

**DO NOT DESIGN WITH THESE DIMENSIONS - PRELIMINARY**

**TSOP5 (5 Pin) DEVICE**

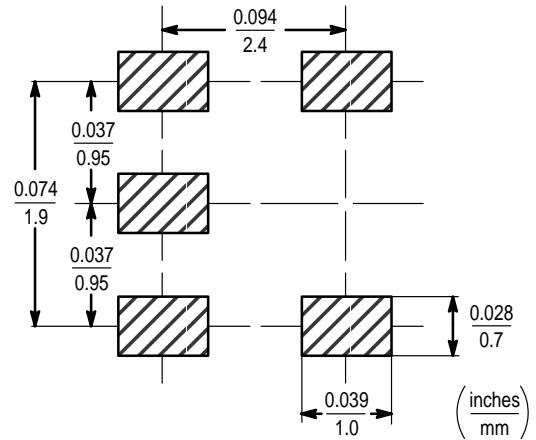
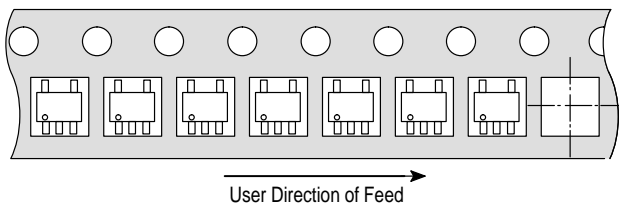

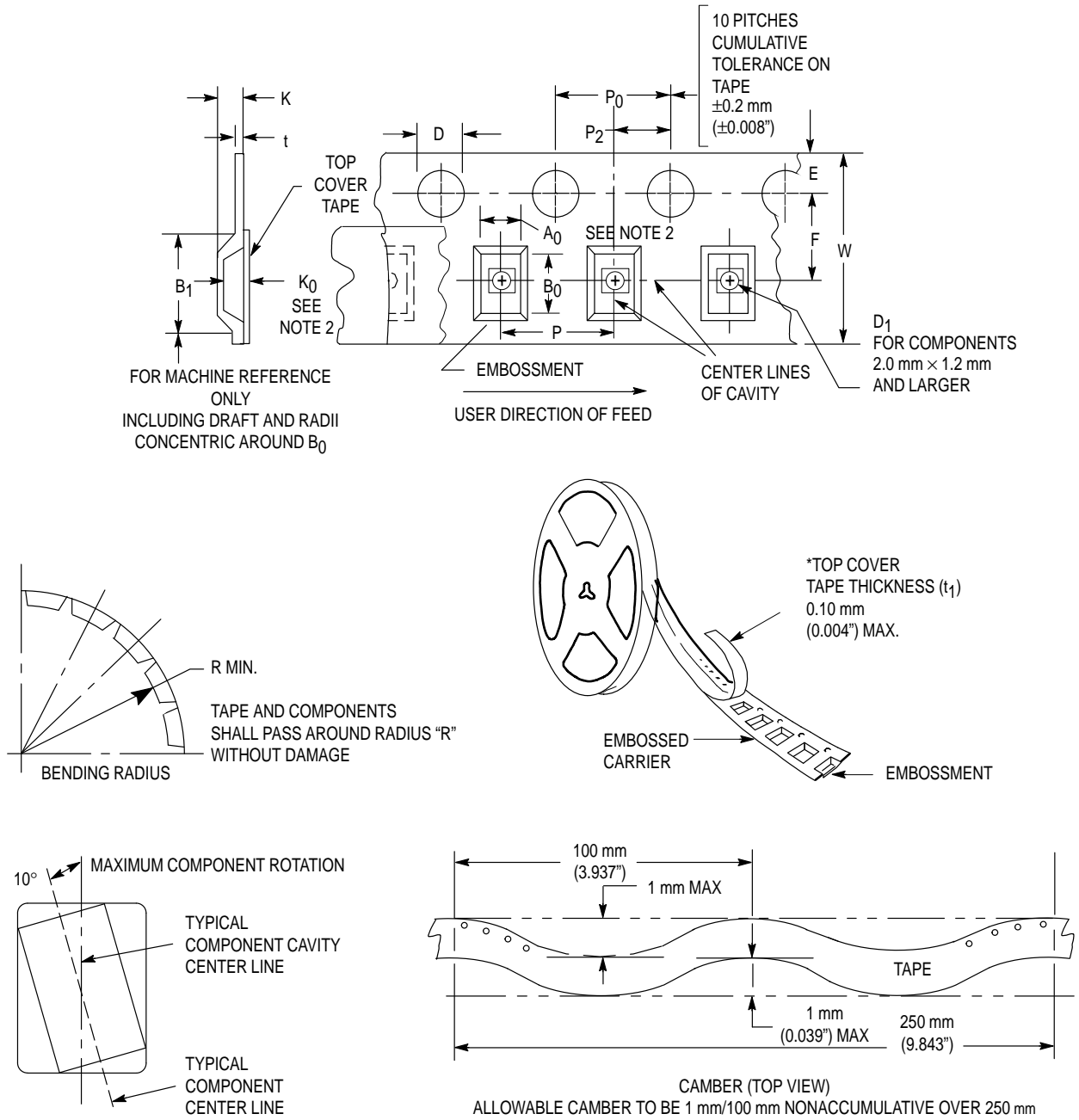

Figure 5. Carrier Tape Specifications

EMBOSSSED CARRIER DIMENSIONS (See Notes 1 and 2)

Tape Size	$B_1$ Max	D	$D_1$	E	F	K	P	$P_0$	$P_2$	R	T	W
8 mm	4.35 mm (0.171")	1.5 +0.1/-0.0 mm (0.059 +0.004/-0.0")	1.0 mm Min (0.039")	1.75 $\pm 0.1$ mm (0.069 $\pm 0.004$ " )	3.5 $\pm 0.5$ mm (1.38 $\pm 0.002$ " )	2.4 mm (0.094")	4.0 $\pm 0.10$ mm (0.157 $\pm 0.004$ " )	4.0 $\pm 0.1$ mm (0.156 $\pm 0.004$ " )	2.0 $\pm 0.1$ mm (0.079 $\pm 0.002$ " )	25 mm (0.98")	0.3 $\pm 0.05$ mm (0.01 $\pm 0.0038$ / -0.0002")	8.0 $\pm 0.3$ mm (0.315 $\pm 0.012$ " )

- Metric Dimensions Govern—English are in parentheses for reference only.
- $A_0$ ,  $B_0$ , and  $K_0$  are determined by component size. The clearance between the components and the cavity must be within 0.05 mm min to 0.50 mm max. The component cannot rotate more than 10° within the determined cavity

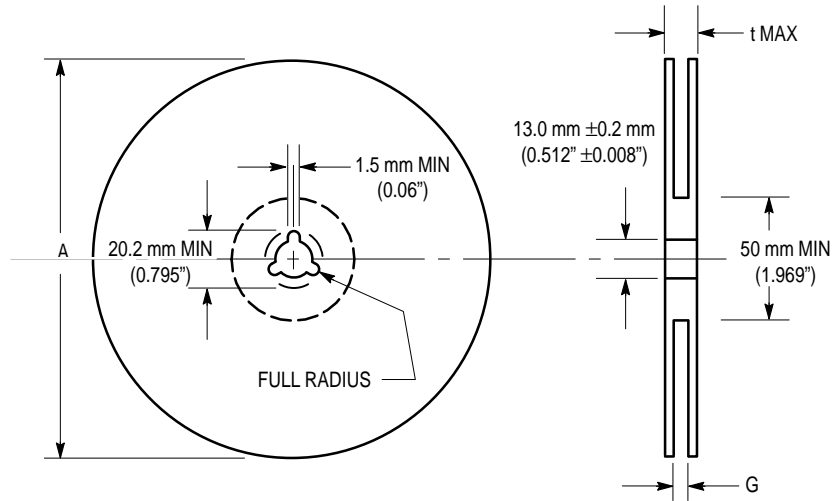

Figure 6. Reel Dimensions

REEL DIMENSIONS

Tape Size	A Max	G	t Max
8 mm	330 mm (13")	8,400 mm, +1.5 mm, -0.0 (0.33", +0.059", -0.00)	14.4 mm (0.56")

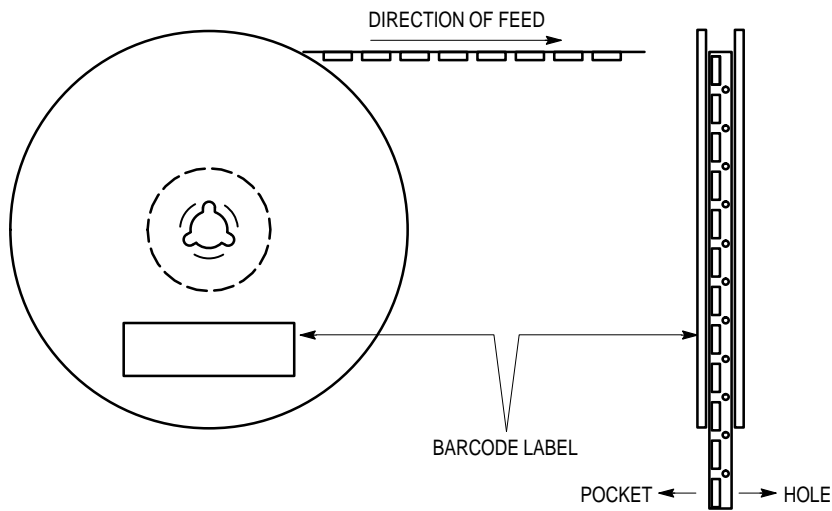

Figure 7. Reel Winding Direction

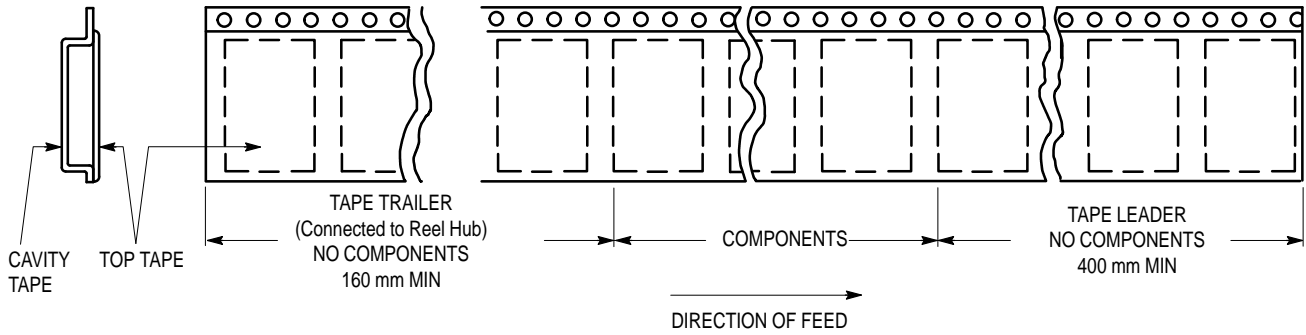



Figure 8. Tape Ends for Finished Goods

Motorola reserves the right to make changes without further notice to any products herein. Motorola makes no warranty, representation or guarantee regarding the suitability of its products for any particular purpose, nor does Motorola assume any liability arising out of the application or use of any product or circuit, and specifically disclaims any and all liability, including without limitation consequential or incidental damages. "Typical" parameters which may be provided in Motorola data sheets and/or specifications can and do vary in different applications and actual performance may vary over time. All operating parameters, including "Typicals" must be validated for each customer application by customer's technical experts. Motorola does not convey any license under its patent rights nor the rights of others. Motorola products are not designed, intended, or authorized for use as components in systems intended for surgical implant into the body, or other applications intended to support or sustain life, or for any other application in which the failure of the Motorola product could create a situation where personal injury or death may occur. Should Buyer purchase or use Motorola products for any such unintended or unauthorized application, Buyer shall indemnify and hold Motorola and its officers, employees, subsidiaries, affiliates, and distributors harmless against all claims, costs, damages, and expenses, and reasonable attorney fees arising out of, directly or indirectly, any claim of personal injury or death associated with such unintended or unauthorized use, even if such claim alleges that Motorola was negligent regarding the design or manufacture of the part. Motorola and  are registered trademarks of Motorola, Inc. Motorola, Inc. is an Equal Opportunity/Affirmative Action Employer.

Mfax is a trademark of Motorola, Inc.

**How to reach us:**

**USA/EUROPE/Locations Not Listed:** Motorola Literature Distribution; P.O. Box 5405, Denver, Colorado 80217. 1-303-675-2140 or 1-800-441-2447

**JAPAN:** Nippon Motorola Ltd.; SPD, Strategic Planning Office, 141, 4-32-1 Nishi-Gotanda, Shinagawa-ku, Tokyo, Japan. 81-3-5487-8488

**Customer Focus Center: 1-800-521-6274**

**Mfax™:** RMFAX0@email.sps.mot.com – TOUCHTONE 1-602-244-6609  
 Motorola Fax Back System – US & Canada ONLY 1-800-774-1848  
 – http://sps.motorola.com/mfax/

**ASIA/PACIFIC:** Motorola Semiconductors H.K. Ltd.; 8B Tai Ping Industrial Park, 51 Ting Kok Road, Tai Po, N.T., Hong Kong. 852-26629298

**HOME PAGE:** <http://motorola.com/sps/>

