

Photologic[®] Slotted Optical Switch

Types OPB625, OPB626, OPB627, OPB628

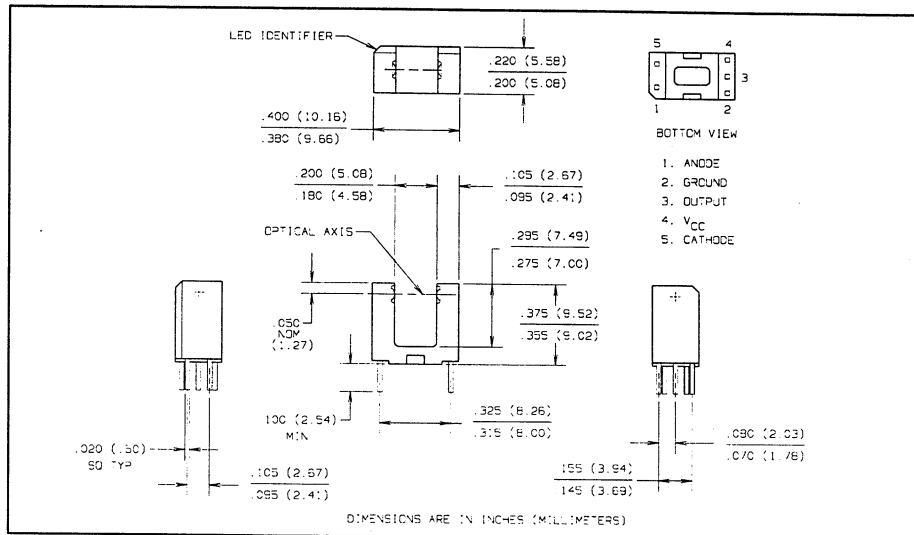
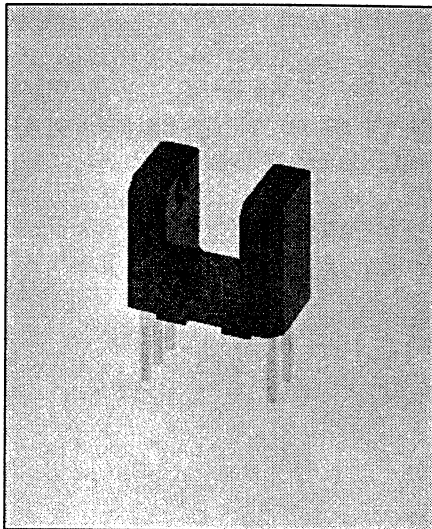

Features

- Non-contact switching
- Printed circuit board mounting
- 0.320" (8.13 mm) Lead centers
- 0.190" (4.83 mm) Gap
- Enhanced signal to noise ratio
- Four output options

Description

The OPB625 series slotted optical switches consist of an infrared emitting diode and a monolithic integrated circuit which incorporates a photodiode, a linear amplifier and a Schmitt trigger on a single silicon chip.

The device features TTL/LSTTL compatible logic level output. Open collector output versions can drive up to 10 TTL loads over a voltage range from 4.5V to 16V.

Absolute Maximum Ratings (T_A = 25° C unless otherwise noted)

Storage Temperature Range -40° C to +100° C
 Operating Temperature Range -40° C to +100° C
 Lead Soldering Temperature [1/16 inch (1.6 mm) from case for 5 sec. with soldering iron]. 240° C⁽¹⁾

Input Diode

Forward DC Current 50 mA
 Peak Forward Current (1μs pulse width, 300 pps) 3.0 A
 Reverse DC Voltage 3.0 V
 Power Dissipation 100 mW⁽²⁾

Output Photologic[®]

Supply Voltage, V_{CC} 18 V
 Duration of Output Short To V_{CC} 1.00 sec
 Voltage at Output 30 V
 Low Level Output Current (sinking) 16 mA
 Power Dissipation 240 mW⁽³⁾

Notes:

- (1) RMA flux is recommended. Duration can be extended to 10 sec. max. when flow soldering.
 (2) Derate linearly 1.33 mW/° C above 25° C.
 (3) Derate linearly 2.50 mW/° C above 30° C.

Schematics

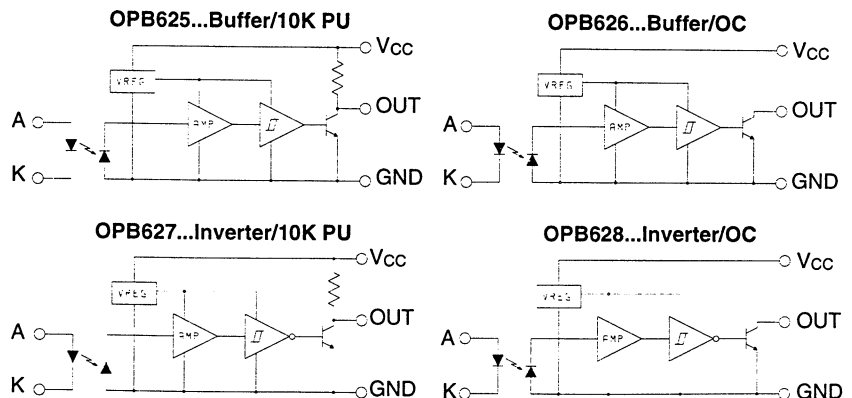

Types OPB625, OPB626, OPB627, OPB628

Electrical Characteristics ($T_A = 25^\circ\text{C}$, $V_{CC} = 4.5\text{ V to }16\text{ V}$ unless otherwise noted)

SYMBOL	PARAMETER	MIN	TYP	MAX	UNITS	TEST CONDITIONS
Input Diode						
V_F	Forward Voltage			1.6	V	$I_F = 10\text{ mA}$
I_R	Reverse Current			100	μA	$V_R = 3.0\text{ V}$
Output Photologic[®] Sensor						
V_{CC}	Operating D.C. Supply Voltage	4.5		16.0	V	
$I_F(+)$	LED Positive-Going Threshold Current	0.1	0.6	3.0	mA	
$I_F(+)/I_F(-)$	Hysteresis Ratio	1.05	1.20	1.60		
I_{CCH}	High Level Supply Current:					
	Buffer, 10K Pull-up OPB625 Buffer, Open-Collector OPB626		5.0	12.0	mA	$I_F = 5\text{ mA}$, No Load On Output
	Inverter, 10K Pull-up OPB627 Inverter, Open-Collector OPB628		4.0	12.0	mA	$I_F = 0\text{ mA}^{(4)}$, No Load On Output
	Low Level Supply Current:					
I_{CCL}	Buffer, 10K Pull-up OPB625 Buffer, Open-Collector OPB626		5.5	12.0	mA	$I_F = 0\text{ mA}^{(4)}$, No Load On Output
	Inverter, 10K Pull-up OPB627 Inverter, Open-Collector OPB628		6.5	12.0	mA	$I_F = 5\text{ mA}$, No Load On Output
V_{OH}	High Level Output Voltage:					
	Buffer, 10K Pull-up OPB625 Inverter, 10K Pull-up OPB627	$(V_{CC}-1.5)$			V	$I_F = 5\text{ mA}$, $I_{OH} = 100\ \mu\text{A}$
I_{OH}	High Level Output Current:					
	Buffer, Open-Collector OPB626 Inverter, Open-Collector OPB628			100	μA	$I_F = 5\text{ mA}$, $V_{OH} = 30\text{ V}$
V_{OL}	Low Level Output Voltage:					
	Buffer, 10K Pull-up OPB625 Buffer, Open-Collector OPB626			0.4	V	$I_F = 0\text{ mA}^{(4)}$, $I_{OL} = 16\text{ mA}$
	Inverter, 10K Pull-up OPB627 Inverter, Open-Collector OPB628			0.4	V	$I_F = 5\text{ mA}$, $I_{OL} = 16\text{ mA}$
	Output Rise Time, Output Fall Time		30		ns	
t_{PLH}	Propagation Delay, Low-High					
	Buffer, 10K Pull-up OPB625 Buffer, Open-Collector OPB626		0.6		μs	$I_F = 0\text{ or }5\text{ mA}$, $f = 10\text{ kHz}$, DC = 50%, $R_L = 300\ \Omega$
	Inverter, 10K Pull-up OPB627 Inverter, Open-Collector OPB628		3.0		μs	
	Propagation Delay, High-Low					
Buffer, 10K Pull-up OPB625 Buffer, Open-Collector OPB626		3.0		μs		
t_{PHL}	Inverter, 10K Pull-up OPB627 Inverter, Open-Collector OPB628		0.6		μs	
	Data Rate		100		KHz	$I_F = 0\text{ or }5\text{ mA}$, DC = 50%, $R_L = 300\ \Omega$

(4) Normal application would be with light source blocked, simulated by $I_F = 0\text{ mA}$.

Typical Performance Curves

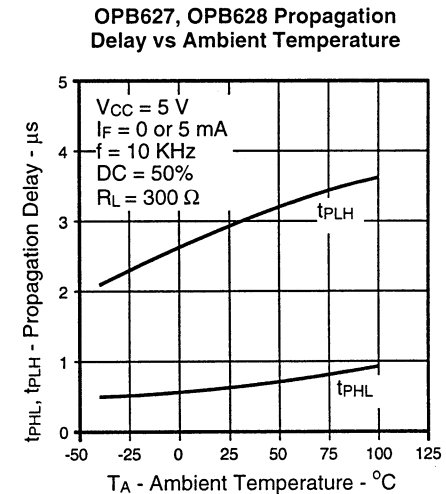
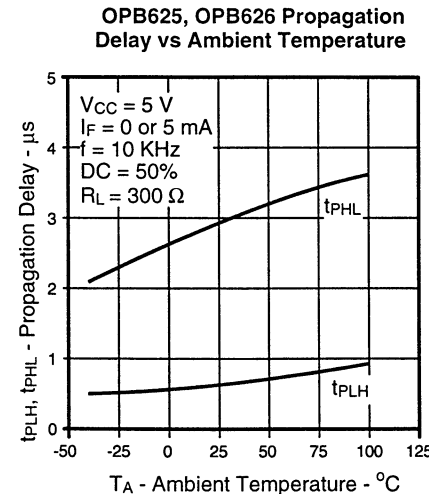
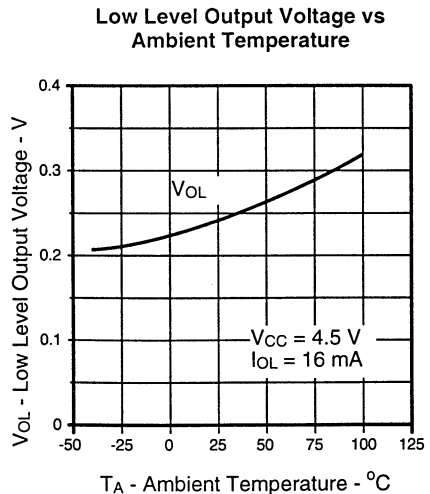
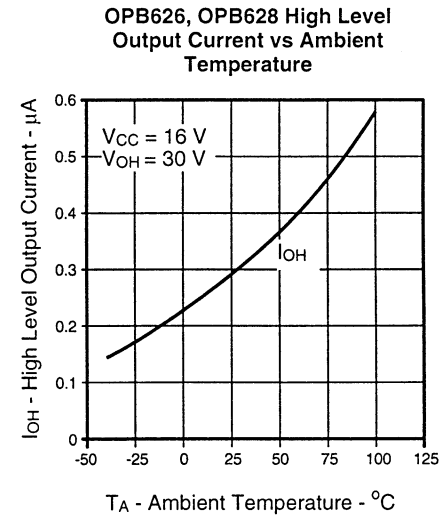
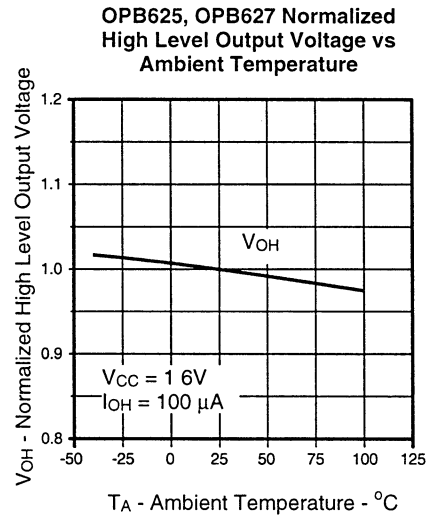
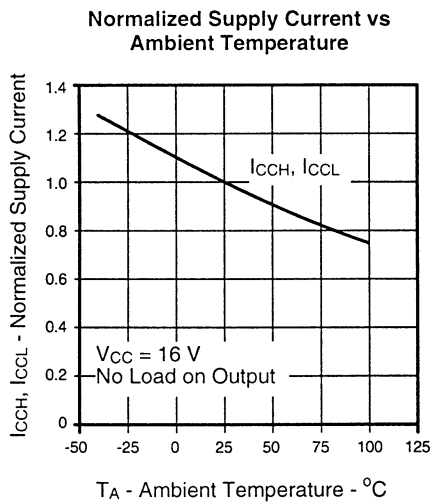
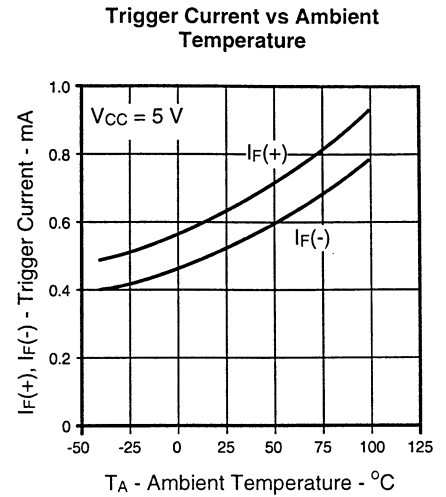
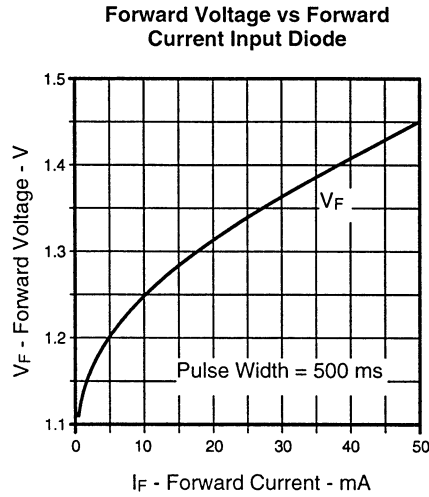
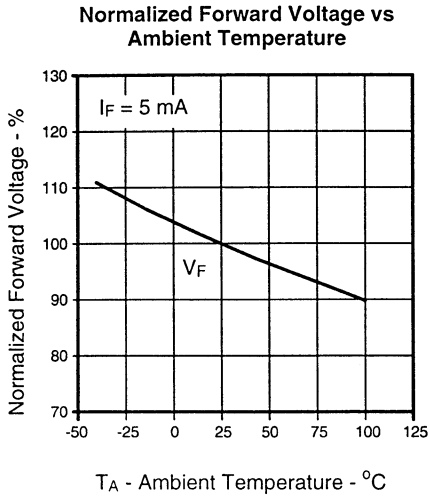

Types OPB625, OPB626, OPB627, OPB628

Typical Performance Curves

Rise Time and Fall Time vs Ambient Temperature

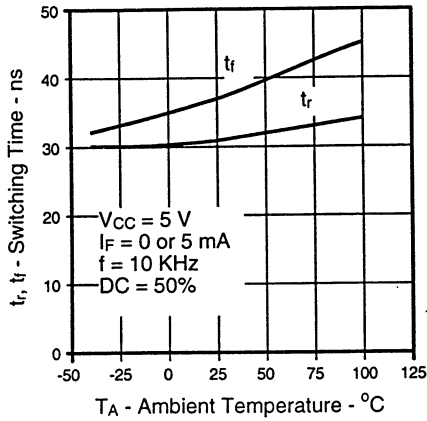

Rise Time vs Output Load vs Ambient Temperature

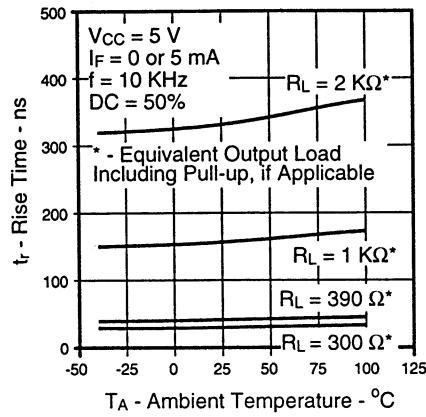

Maximum Data Rate vs Ambient Temperature

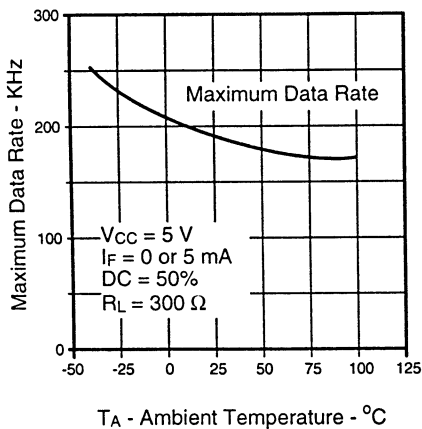

Typical Thermal Derating Curve

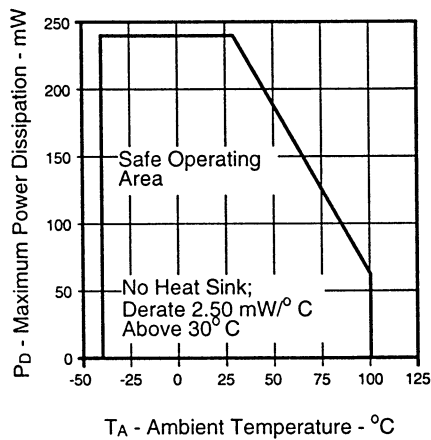

SLOTTED
OPTICAL
SWITCHES

Optek reserves the right to make changes at any time in order to improve design and to supply the best product possible.

Optek Technology, Inc. 1215 W. Crosby Road Carrollton, Texas 75006 (972)323-2200 Fax (972)323-2396