

Photologic® Slotted Optical Switch

Types OPB665N/T, OPB666N/T, OPB667N/T, OPB668N/T

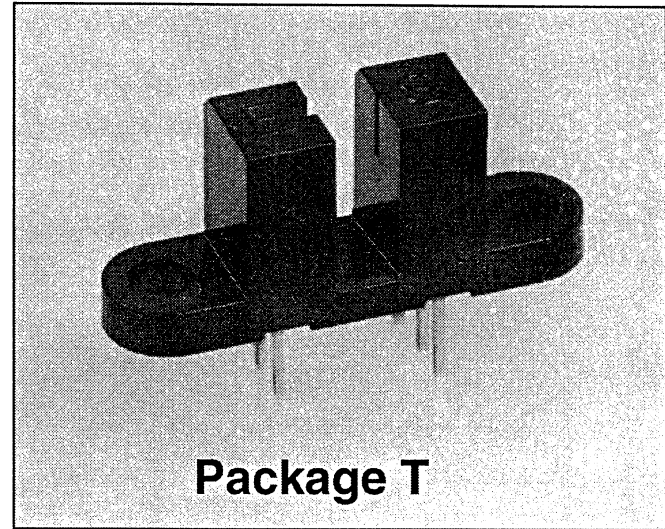
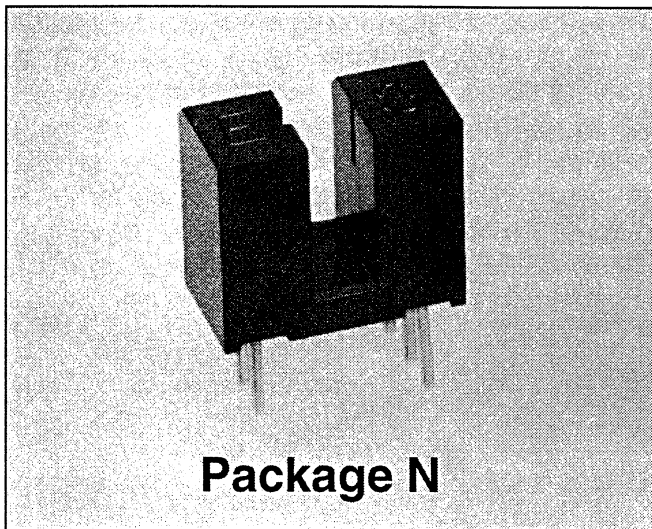

Features

- Four Output Options
- 0.125" (3.18 mm) Wide Gap
- 0.320" (8.13 mm) Lead Spacing
- N or T Package
- 0.010" Sensor Aperture

Description

The OPB665 series optical switches consist of a monolithic integrated circuit and an infrared emitting diode mounted on opposite sides of a 0.125" (3.18 mm) wide slot. The emitter has a 0.050" x 0.060" molded-in aperture while the sensor has a 0.010" x 0.060" molded-in aperture.

The device features TTL/LSTTL compatible logic level output, which can drive up to 10 TTL loads over a voltage range from 4.5 V to 16 V.

Absolute Maximum Ratings (T_A = 25° C unless otherwise noted)

| | |
|--|-----------------------|
| Storage Temperature Range | -40° C to +100° C |
| Operating Temperature Range | -40° C to +100° C |
| Lead Soldering Temperature [1/16 inch (1.6 mm) from case for 5 sec. with soldering iron] | 240° C ⁽¹⁾ |

Input Diode

| | |
|---|-----------------------|
| Forward DC Current | 50 mA |
| Peak Forward Current (1µs pulse width, 300 pps) | 3.0 A |
| Reverse DC Voltage | 3.0 V |
| Power Dissipation | 100 mW ⁽²⁾ |

Output Photologic®

| | |
|---|-----------------------|
| Supply Voltage, V _{CC} | 18 V |
| Duration of Output Short To V _{CC} | 1.0 sec |
| Voltage at Output | 30 V |
| Low Level Output Current (sinking) | 16 mA |
| Power Dissipation | 240 mW ⁽³⁾ |

Notes:

- (1) RMA flux is recommended. Duration can be extended to 10 sec. max. when flow soldering.
- (2) Derate linearly 1.33 mW/° C above 25° C.
- (3) Derate linearly 2.50 mW/° C above 30° C.

Schematics

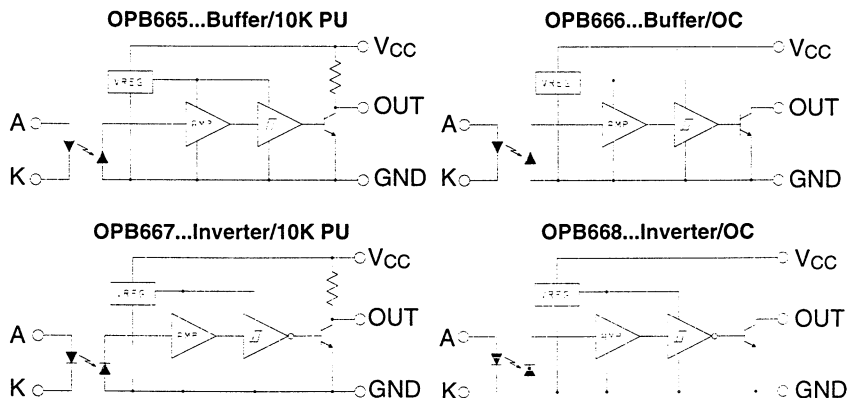

Types OPB665N/T, OPB666N/T, OPB667N/T, OPB668N/T

SLOTTED OPTICAL SWITCHES

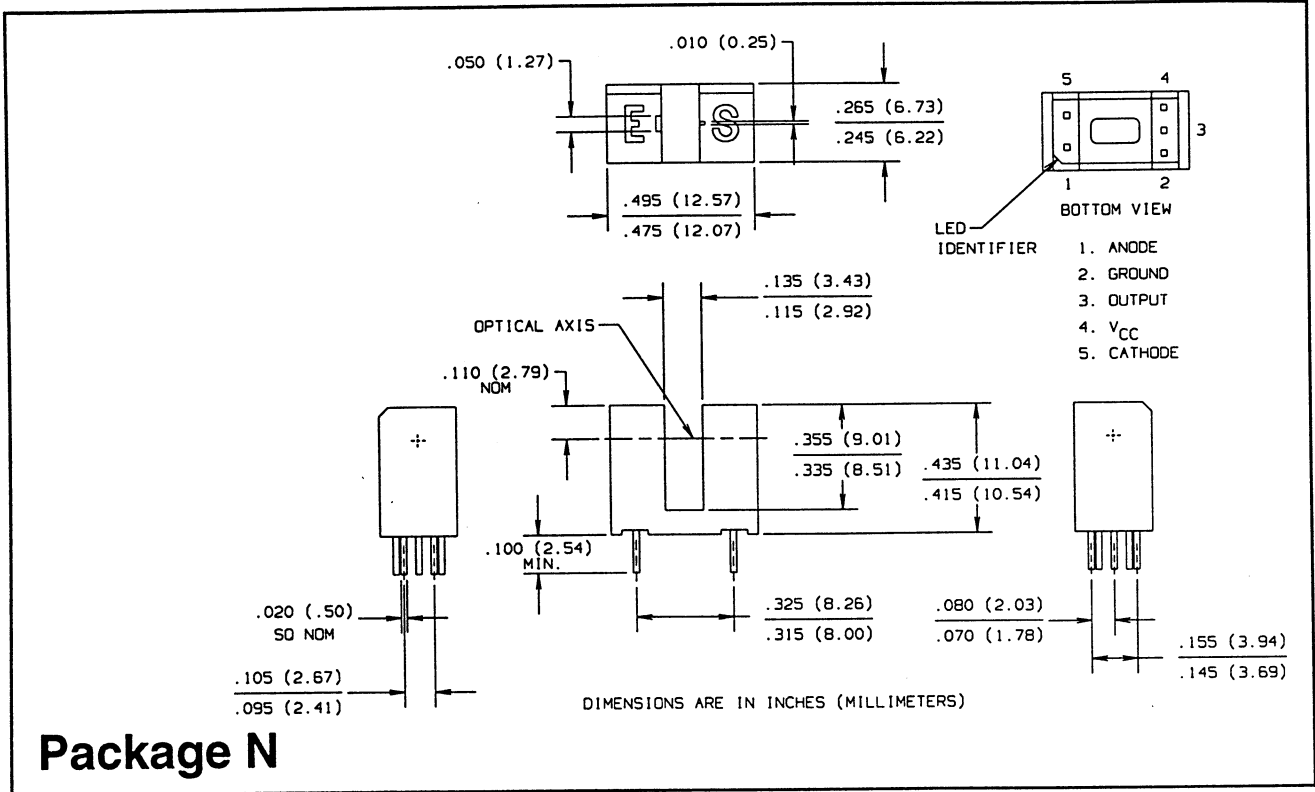

Package N

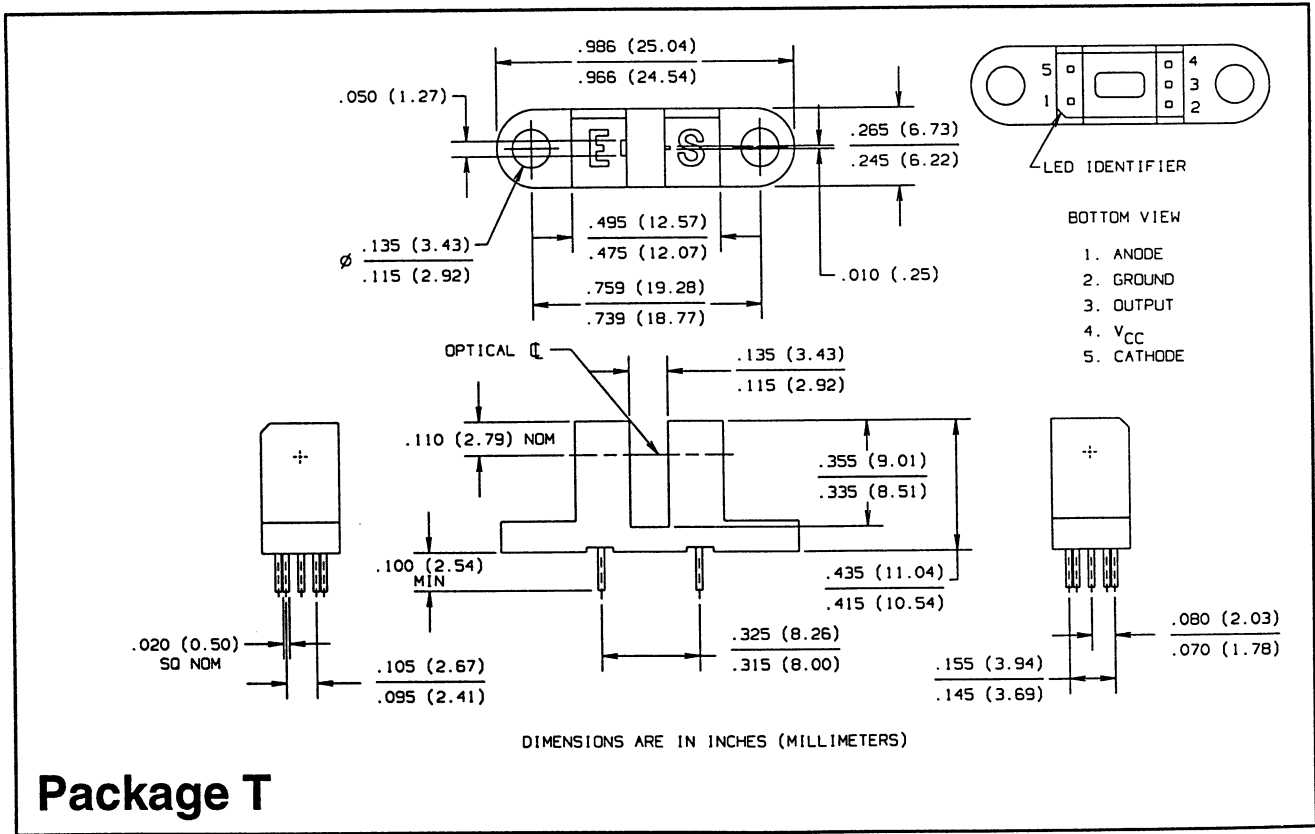

Package T

Types OPB665N/T, OPB666N/T, OPB667N/T, OPB668N/T

Electrical Characteristics ($T_A = 25^\circ\text{C}$ unless otherwise noted)

| SYMBOL | PARAMETER | MIN | TYP | MAX | UNITS | TEST CONDITIONS |
|----------------------------------|---|--|------|------|---------------|--|
| Input Diode | | | | | | |
| V_F | Forward Voltage | | | 1.6 | V | $I_F = 10\text{ mA}$ |
| I_R | Reverse Current | | | 100 | μA | $V_R = 3.0\text{ V}$ |
| Output Photologic™ Sensor | | | | | | |
| V_{CC} | Operating D.C. Supply Voltage | 4.5 | | 16.0 | V | |
| $I_F(+)$ | LED Positive-Going Threshold Current | 0.1 | 1.6 | 10 | mA | $V_{CC} = 5.0\text{ V}$ |
| $I_F(+)/I_F(-)$ | Hysteresis Ratio | 1.05 | 1.20 | 1.60 | | $V_{CC} = 5.0\text{ V}$ |
| I_{CCH} | High Level Supply Current: | | | | | |
| | Buffer, 10K Pull-up OPB665 Buffer, Open-Collector OPB666 | | 5.0 | 12.0 | mA | $V_{CC} = 16\text{ V}$, No Load On Output, $I_F = 10\text{ mA}$ |
| I_{CCH} | Inverter, 10K Pull-up OPB667 Inverter, Open-Collector OPB668 | | 4.0 | 12.0 | mA | $V_{CC} = 16\text{ V}$, No Load On Output, $I_F = 0\text{ mA}$ |
| | I_{CCL} | Low Level Supply Current: | | | | |
| I_{CCL} | Buffer, 10K Pull-up OPB665 Buffer, Open-Collector OPB666 | | 5.5 | 12.0 | mA | $V_{CC} = 16\text{ V}$, No Load On Output, $I_F = 0\text{ mA}$ |
| | I_{CCL} | Inverter, 10K Pull-up OPB667 Inverter, Open-Collector OPB668 | | 6.5 | 12.0 | mA |
| V_{OH} | | High Level Output Voltage: | | | | |
| | Buffer, 10K Pull-up OPB665 Inverter, 10K Pull-up OPB667 | $(V_{CC}-1.5)^{(5)}$ | | | V | $I_{OH} = 100\text{ }\mu\text{A}$, $I_F = 10\text{ mA}$ |
| I_{OH} | High Level Output Current: | | | | | |
| | Buffer, Open-Collector OPB666 Inverter, Open-Collector OPB668 | | | 100 | μA | $V_{CC} = 16\text{ V}$, $V_{OH} = 30\text{ V}$, $I_F = 10\text{ mA}$ |
| V_{OL} | Low Level Output Voltage: | | | | | |
| | Buffer, 10K Pull-up OPB665 Buffer, Open-Collector OPB666 | | | 0.4 | V | $V_{CC} = 4.5\text{ V}$, $I_{OL} = 16\text{ mA}$, $I_F = 0\text{ mA}^{(4)}$ |
| V_{OL} | Inverter, 10K Pull-up OPB667 Inverter, Open-Collector OPB668 | | | 0.4 | V | $V_{CC} = 4.5\text{ V}$, $I_{OL} = 16\text{ mA}$, $I_F = 10\text{ mA}$ |
| | t_r, t_f | Output Rise Time, Output Fall Time | | 30 | ns | |
| t_{PLH} | Propagation Delay, Low-High | | | | | $V_{CC} = 5\text{ V}$, $I_F = 0$ or 10 mA , $f = 10\text{ kHz}$, DC = 50%, $R_L = 300\text{ }\Omega$ |
| | Buffer, 10K Pull-up OPB665 Buffer, Open-Collector OPB666 | | 1.0 | | μs | |
| | Inverter, 10K Pull-up OPB667 Inverter, Open-Collector OPB668 | | 2.0 | | μs | |
| | t_{PHL} | Propagation Delay, High-Low | | | | |
| t_{PHL} | Buffer, 10K Pull-up OPB665 Buffer, Open-Collector OPB666 | | 2.0 | | μs | |
| | Inverter, 10K Pull-up OPB667 Inverter, Open-Collector OPB668 | | 1.0 | | μs | |
| | Data Rate | Data Rate | | 100 | kHz | $V_{CC} = 5\text{ V}$, $I_F = 0$ or 10 mA , DC = 50%, $R_L = 300\text{ }\Omega$ |

(4) Normal application would be with light source blocked, simulated by $I_F = 0\text{ mA}$.

(5) $V_{OH} = V_{CC}-1.5$ for $V_{CC} = 4.5\text{ V}$ to 16 V .

Types OPB665N/T, OPB666N/T, OPB667N/T, OPB668N/T

Typical Performance Curves

SLOTTED OPTICAL SWITCHES

Normalized Forward Voltage vs Ambient Temperature

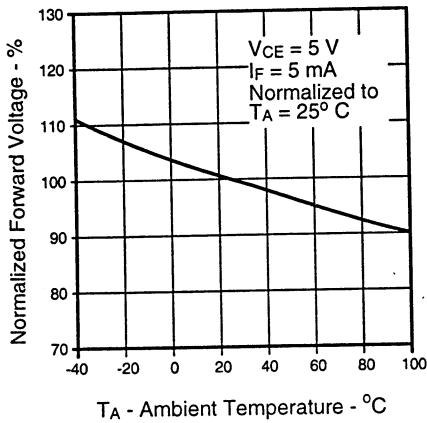

Forward Current vs Forward Voltage Input Diode

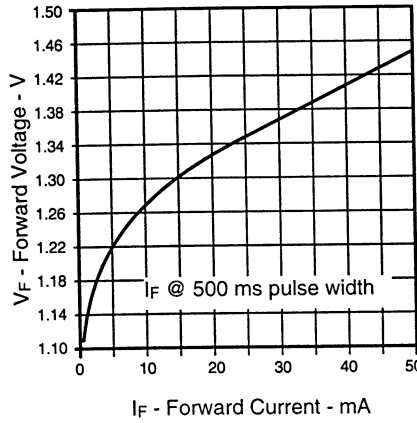

Trigger Current vs Ambient Temperature

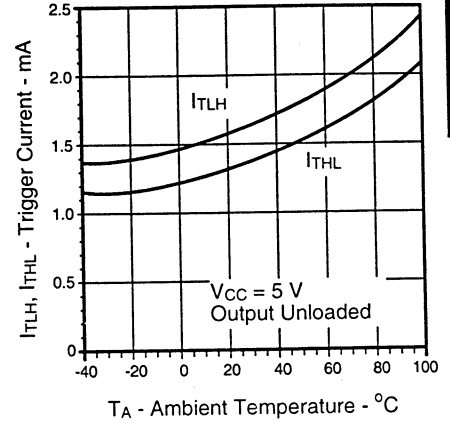

Normalized Supply Current vs Ambient Temperature

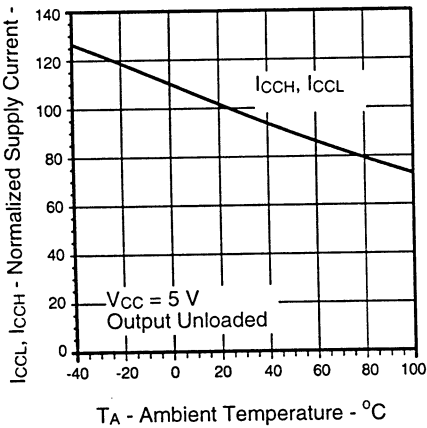

OPB665, OPB667 Normalized High Level Output Voltage vs Ambient Temperature

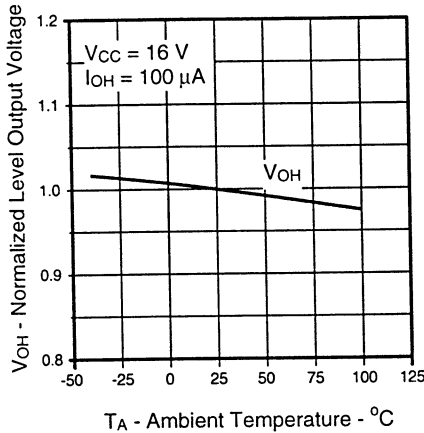

OPB666, OPB668 High Level Output Current vs Ambient Temperature

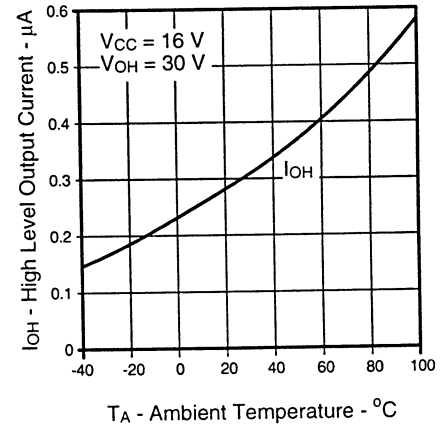

Low Level Output Voltage vs Ambient Temperature

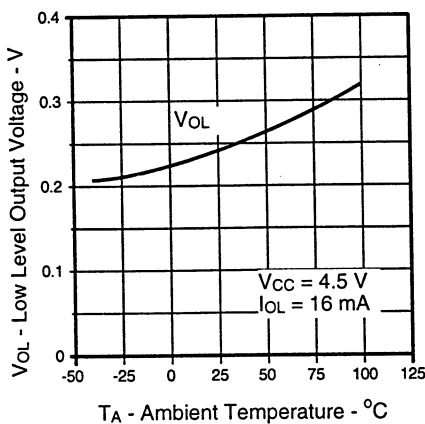

OPB665, OPB666 Propagation Delay vs Ambient Temperature

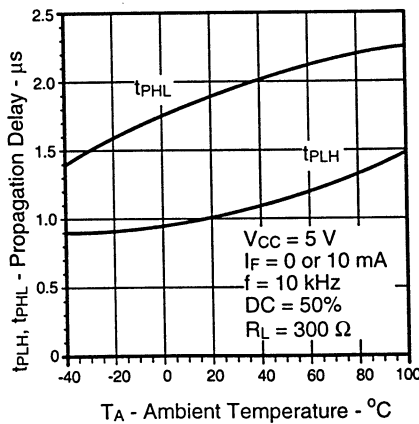

OPB667, OPB668 Propagation Delay vs Ambient Temperature

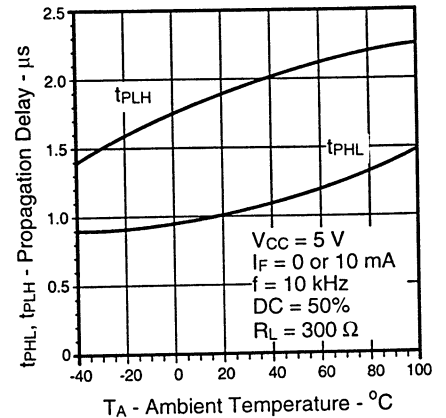

Types OPB665N/T, OPB666N/T, OPB667N/T, OPB668N/T

Typical Performance Curves

Switching Time vs Ambient Temperature

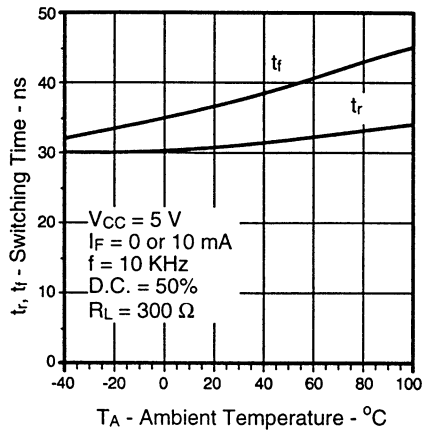

Rise Time vs Output Load vs Ambient Temperature

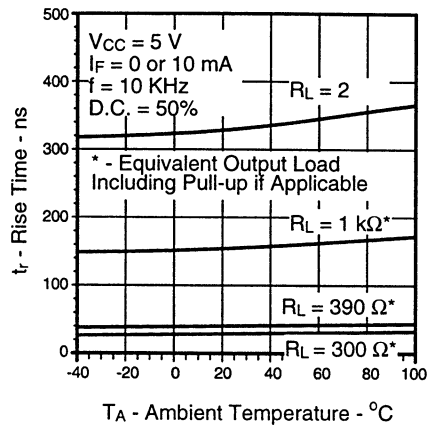

Maximum Data Rate vs Ambient Temperature

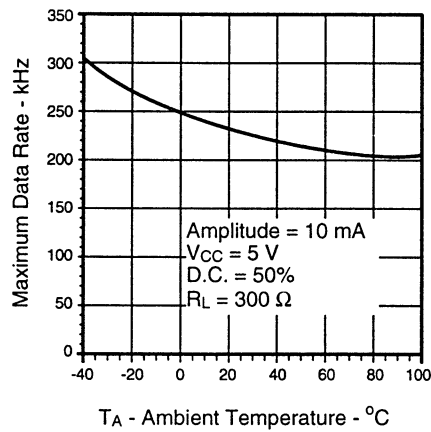

Typical Thermal Derating Curve

