

Reflective Object Sensors

Types OPB708, OPB709

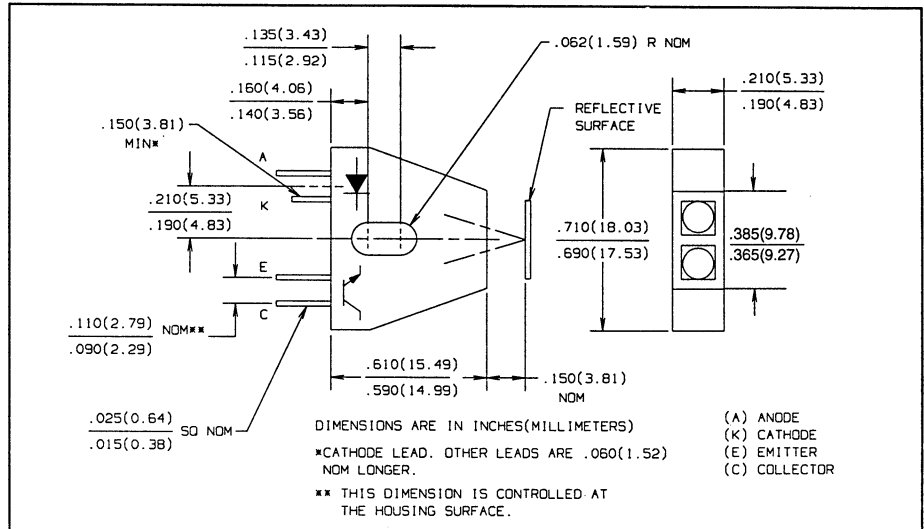
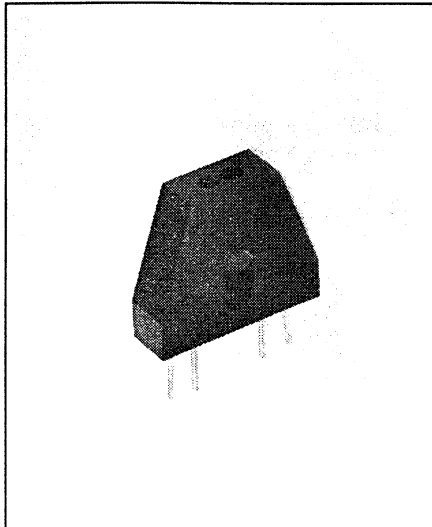

Features

- Focused for maximum sensitivity
- Phototransistor (OPB708) or photodarlington (OPB709) output
- Crosstalk does not exceed specified I_{CEO}
- Low cost plastic housing

Description

The OPB708 and OPB709 each consists of an infrared emitting diode and an NPN silicon phototransistor (OPB708) or photodarlington (OPB709), mounted side-by-side on converging optical axes, in a black plastic housing. Maximum sensitivity typically occurs 0.125 inches from the front of the housing.

The photosensor responds to radiation from the LED only when a reflective object passes within its field of view.

Both parts are constructed using either OP165 or OP265 series LEDs. The OPB708 uses an OP505 type phototransistor and the OPB709 uses an OP535 type photodarlington.

Absolute Maximum Ratings ($T_A = 25^\circ\text{C}$ unless otherwise noted)

Storage Temperature Range	-40°C to $+85^\circ\text{C}$
Operating Temperature Range	-40°C to $+85^\circ\text{C}$
Lead soldering temperature (1/6 inch [1.6 mm] from case for 5 sec. with soldering iron)	240°C

Input Diode

Reverse Voltage	2.0 V
Continuous Forward Current	40 mA
Power Dissipation	$60\text{ mW}^{(2)}$

Output Photosensor

Collector-Emitter Voltage - OPB708	30 V
OPB709	15 V
Emitter-Collector Voltage	5.0 V
Power Dissipation - OPB708	$50\text{ mW}^{(3)}$
OPB709	$125\text{ mW}^{(4)}$

Notes:

- (1) RMA flux is recommended. Duration can be extended to 10 sec. max. when flow soldering.
- (2) Derate linearly $1.00\text{ mW}/^\circ\text{C}$ above 25°C .
- (3) Derate linearly $0.83\text{ mW}/^\circ\text{C}$ above 25°C .
- (4) Derate linearly $2.08\text{ mW}/^\circ\text{C}$ above 25°C .
- (5) d is the distance from the assembly face to the reflective surface.
- (6) Reflective surface is Eastman Kodak neutral white test card with 90% diffuse reflectance as a reflecting surface. Reference: Eastman Kodak, Catalog #1257795.
- (7) Lower curve is based on a calculated worst case condition rather than the conventional -2σ limit.

Types OPB708

Electrical Characteristics ($T_A = 25^\circ\text{C}$ unless otherwise noted)

REFLECTIVE OBJECT SENSORS

SYMBOL	PARAMETER	MIN	MAX	UNITS	TEST CONDITIONS
Input Diode					
V_F	Forward Voltage		1.70	V	$I_F = 40\text{ mA}$
I_R	Reverse Current		100	μA	$V_R = 2.0\text{ V}$
Output Phototransistor					
$V_{(BR)CEO}$	Collector-Emitter Breakdown Voltage	30		V	$I_C = 100\ \mu\text{A}$
$V_{(BR)ECO}$	Emitter-Collector Breakdown Voltage	5.0		V	$I_E = 100\ \mu\text{A}$
I_{CEO}	Collector Dark Current		100	nA	$V_{CE} = 10.0\text{ V}, I_F = 0, E_e = 0$
Combined					
$I_{C(ON)}$	On-State Collector Current	10.0		μA	$V_{CE} = 5.0\text{ V}, I_F = 40\text{ mA}, d = 0.150\text{'' (3.81 mm)}^{(5)(6)}$
$V_{CE(SAT)}$	Collector-Emitter Saturation Voltage		0.40	V	$I_F = 40\text{ mA}, I_C = 3.0\ \mu\text{A}, d = 0.150\text{'' (3.81 mm)}^{(5)(6)}$

Typical Performance Curves

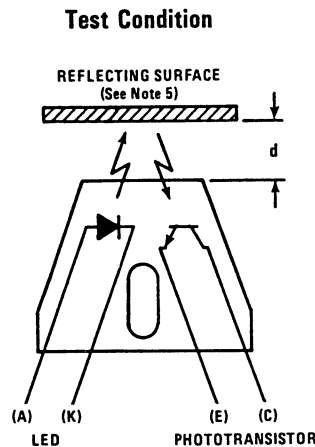
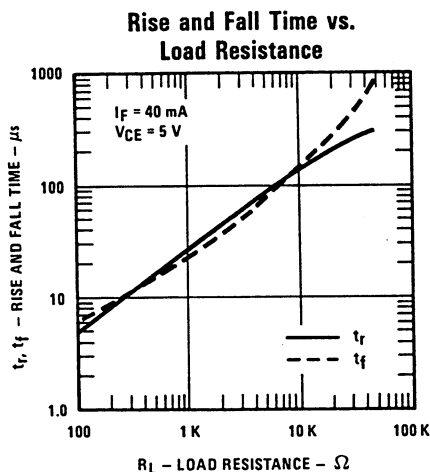
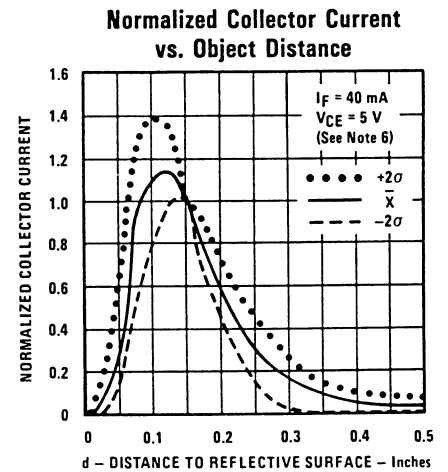
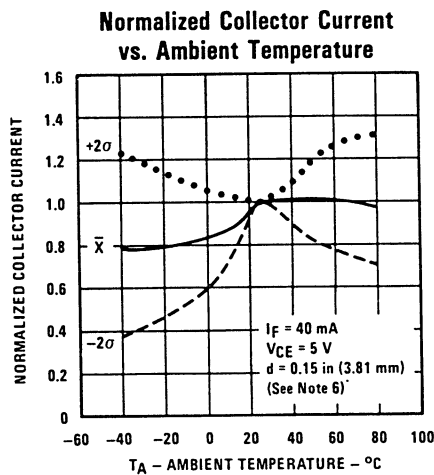
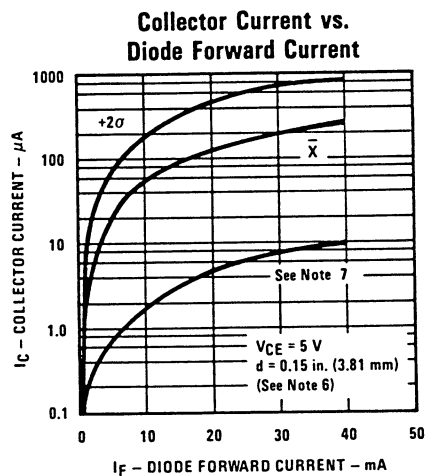

Optek reserves the right to make changes at any time in order to improve design and to supply the best product possible.

Optek Technology, Inc. 1215 W. Crosby Road Carrollton, Texas 75006 (972)323-2200 Fax (972)323-2396

Types OPB709



Electrical Characteristics ($T_A = 25^\circ\text{C}$ unless otherwise noted)

SYMBOL	PARAMETER	MIN	MAX	UNITS	TEST CONDITIONS
Input Diode					
V_F	Forward Voltage		1.70	V	$I_F = 40\text{ mA}$
I_R	Reverse Current		100	μA	$V_R = 2.0\text{ V}$
Output Photodarlington					
$V_{(BR)CEO}$	Collector-Emitter Breakdown Voltage	15.0		V	$I_C = 100\ \mu\text{A}$
$V_{(BR)ECO}$	Emitter-Collector Breakdown Voltage	5.0		V	$I_E = 100\ \mu\text{A}$
I_{CEO}	Collector Dark Current		250	nA	$V_{CE} = 10.0\text{ V}, I_F = 0, E_e = 0$
Combined					
$I_{C(ON)}$	On-State Collector Current	1.00		mA	$V_{CE} = 5.0\text{ V}, I_F = 40\text{ mA}, d = 0.150\text{'' (3.81 mm)}$ ⁽⁵⁾⁽⁶⁾
$V_{CE(SAT)}$	Collector-Emitter Saturation Voltage		1.10	V	$I_F = 40\text{ mA}, I_C = 300\ \mu\text{A}, d = 0.150\text{'' (3.81 mm)}$ ⁽⁵⁾⁽⁶⁾

Typical Performance Curves

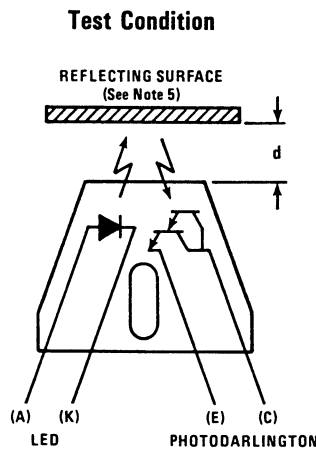
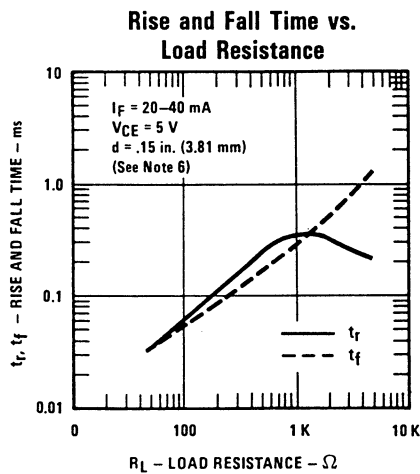
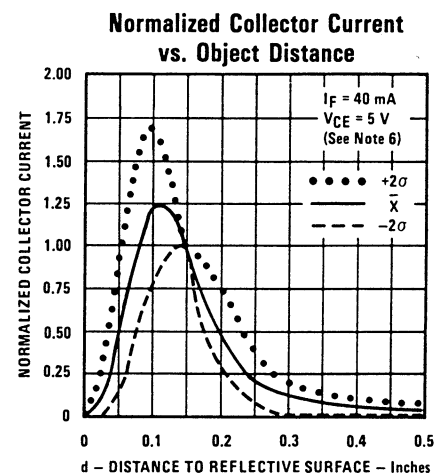
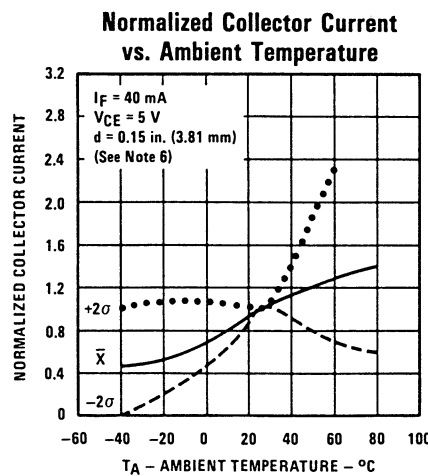
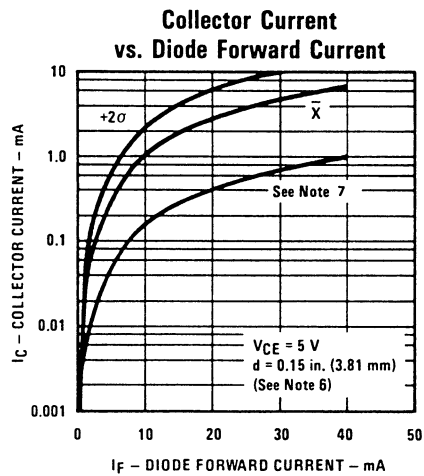

Types OPB708, OPB709

REFLECTIVE
OBJECT
SENSORS

Response Time Test Circuit

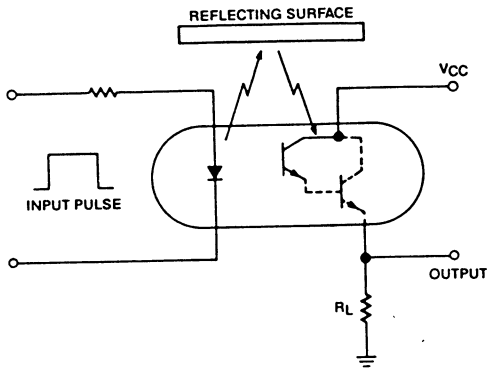

Switching Time Waveforms

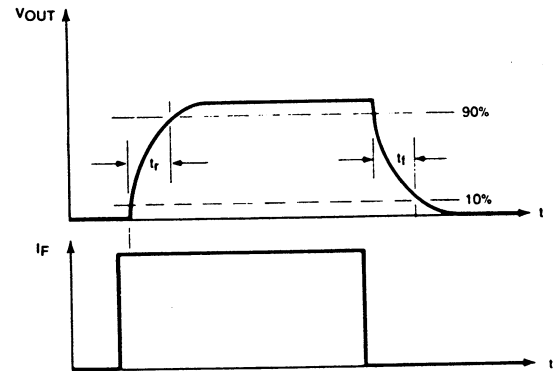

Typical Interfacing Circuit

Recommended for applications requiring adjustments on both sensitivity and hysteresis.

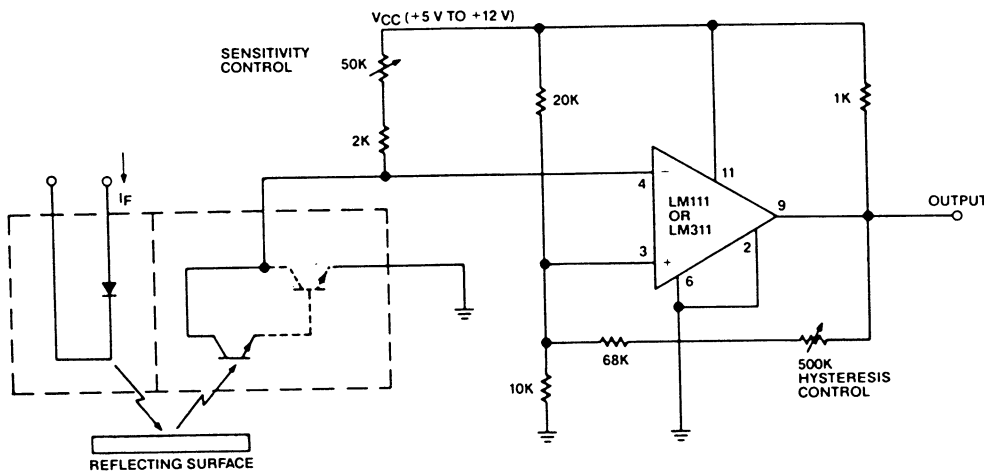

Optek assumes no responsibility for use of any circuits shown and makes no representation that they are free from patent infringement.