

# Photologic® Slotted Optical Switches

## Types OPB930L, OPB940L Series

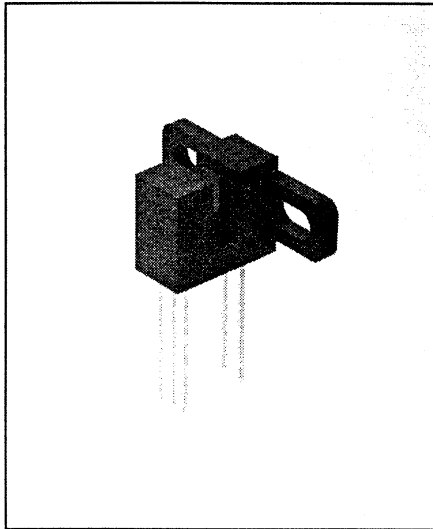

### Features

- 0.320" (8.13 mm) lead space for PC board mount
- Choice of aperture
- Choice of output configuration
- Choice of opaque or IR transmissive shell material
- Data rates to 250 kBaud
- Side mount configuration

### Description

The OPB930L and OPB940L series of Photologic® Photo Integrated Circuit Switches provide optimum flexibility for the design engineer. Building from a standard housing with a 0.125" (3.18 mm) wide slot, the user can specify (1) type and polarity of TTL output, (2) discrete shell material, and (3) aperture width. Available with wire leads as OPB930W/OPB940W series.

The electrical output can be specified as either TTL totem pole or TTL open collector. Either may be supplied with inverter or buffer output polarity. All have added stability of a built-in hysteresis amplifier.

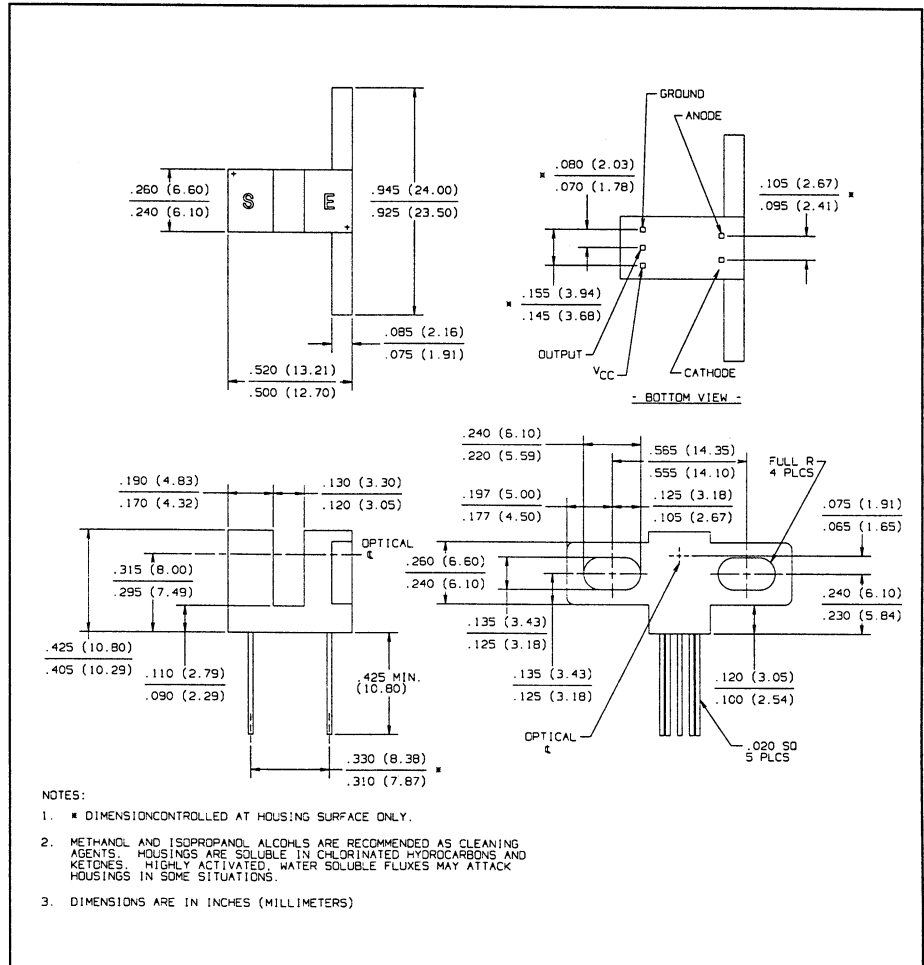

### Absolute Maximum Ratings (T<sub>A</sub> = 25° C unless otherwise noted)

Supply Voltage, V <sub>CC</sub> (Not to exceed 3 sec.)	10 V
Storage Temperature Range	-40° C to +85° C
Operating Temperature Range	-40° C to +70° C
Lead Soldering Temperature [1/16 inch (1.6mm) from case for 5 sec. with soldering iron].	240° C <sup>(1)</sup>
Input Diode Power Dissipation	100 mW <sup>(2)</sup>
Output Photologic® Power Dissipation	200 mW <sup>(3)</sup>
Total Device Power Dissipation	300 mW <sup>(4)</sup>
Voltage at Output Lead (Open Collector Output)	35 V
Diode Forward D.C. Current	40 mA
Diode Reverse D.C. Voltage	2 V

### Notes:

- (1) RMA flux is recommended. Duration can be extended to 10 sec. max. when flow soldering.
- (2) Derate linearly 2.22 mW/° C above 25° C.
- (3) Derate linearly 4.44 mW/° C above 25° C.
- (4) Derate linearly 6.66 mW/° C above 25° C.
- (5) The OPB930L/OPB940L series are terminated with 0.020" square leads designed for printed circuit board mounting.
- (6) Methanol and isopropanol are recommended as cleaning agents. Plastic housing is soluble in chlorinated hydrocarbons and ketones.
- (7) Normal application would be with light source blocked, simulated by I<sub>F</sub> = 0 mA.
- (8) All parameters tested using pulse technique.

# Types OPB930L, OPB940L Series

Electrical Characteristics ( $T_A = -40^\circ\text{C}$  to  $+70^\circ\text{C}$  unless otherwise noted)

SYMBOL	PARAMETER	MIN	TYP	MAX	UNITS	TEST CONDITIONS
<b>Input Diode</b>						
$V_F$	Forward Voltage			1.7	V	$I_F = 20\text{ mA}$ , $T_A = 25^\circ\text{C}$
$I_R$	Reverse Current			100	$\mu\text{A}$	$V_R = 2\text{ V}$ , $T_A = 25^\circ\text{C}$
<b>Output Photologic<sup>®</sup> Sensor</b>						
$V_{CC}$	Operating D.C. Supply Voltage	4.75		5.25	V	
$I_{CCL}$	Low Level Supply Current: Buffered Totem-Pole Output Buffered Open-Collector Output			15	mA	$V_{CC} = 5.25\text{ V}$ , $I_F = 0\text{ mA}^{(7)}$
	Inverted Totem-Pole Output Inverted Open-Collector Output			15	mA	$V_{CC} = 5.25\text{ V}$ , $I_F = 15\text{ mA}$
$I_{CCH}$	High Level Supply Current: Buffered Totem-Pole Output Buffered Open-Collector Output			15	mA	$V_{CC} = 5.25\text{ V}$ , $I_F = 15\text{ mA}$
	Inverted Totem-Pole Output Inverted Open-Collector Output			15	mA	$V_{CC} = 5.25\text{ V}$ , $I_F = 0\text{ mA}^{(7)}$
$V_{OL}$	Low Level Output Voltage: Buffered Totem-Pole Output Buffered Open-Collector Output			0.4	V	$V_{CC} = 4.75\text{ V}$ , $I_{OL} = 12.8\text{ mA}$ $I_F = 0\text{ mA}^{(7)}$
	Inverted Totem-Pole Output Inverted Open-Collector Output			0.4	V	$V_{CC} = 4.75\text{ V}$ , $I_{OL} = 12.8\text{ mA}$ $I_F = 15\text{ mA}$
$V_{OH}$	High Level Output Voltage: Buffered Totem-Pole Output	2.4			V	$V_{CC} = 4.75\text{ V}$ , $I_{OH} = -800\text{ mA}$ $I_F = 15\text{ mA}$
	Inverted Totem-Pole Output	2.4			V	$V_{CC} = 4.75\text{ V}$ , $I_{OH} = -800\text{ mA}$ $I_F = 0\text{ mA}^{(7)}$
$I_{OH}$	High Level Output Current: Buffered Open-Collector Output			100	$\mu\text{A}$	$V_{CC} = 4.75\text{ V}$ , $V_{OH} = 30\text{ V}$ $I_F = 15\text{ mA}$ , $T_A = 25^\circ\text{C}$
	Inverted Open-Collector Output			100	$\mu\text{A}$	$V_{CC} = 4.75\text{ V}$ , $V_{OH} = 30\text{ V}$ $I_F = 0\text{ mA}$ , $T_A = 25^\circ\text{C}$
$I_F(+)$	LED Positive-Going Threshold Current			15	mA	$V_{CC} = 5\text{ V}$ , $T_A = 25^\circ\text{C}$
$I_F(+)/I_F(-)$	Hysteresis		2			$V_{CC} = 5\text{ V}$
$I_{OS}$	Short Circuit Output Current: Buffered Totem-Pole Output	-30		-100	mA	$V_{CC} = 5.25\text{ V}$ , $I_F = 15\text{ mA}$ Output = GND
	Inverted Totem-Pole Output	-30		-100	mA	$V_{CC} = 5.25\text{ V}$ , $I_F = 0\text{ mA}$ Output = GND
$t_r, t_f$	Output Rise Time, Output Fall Time		70		ns	$V_{CC} = 5\text{ V}$ , $T_A = 25^\circ\text{C}$
$t_{PLH}, t_{PHL}$	Propagation Delay Low-High & High-Low		5		$\mu\text{s}$	$I_F = 0$ or $15\text{ mA}$ $R_L = 8\text{ TTL Loads (Totem-Pole)}$ $R_L = 360\ \Omega$ (Open-Collector)

## Housing

All housings are an opaque grade of injection-molded plastic to minimize the assembly's sensitivity to ambient radiation, both visible and near-infrared. Discrete shells (exposed on the parallel faces inside the device throat) are either IR transmissive plastic for applications where aperture contamination may occur or opaque plastic for maximum protection against ambient light.

SLOTTED OPTICAL CHARACTERISTICS

# Types OPB930L, OPB940L Series

## PART NUMBER GUIDE

OPB 9 X X X X X

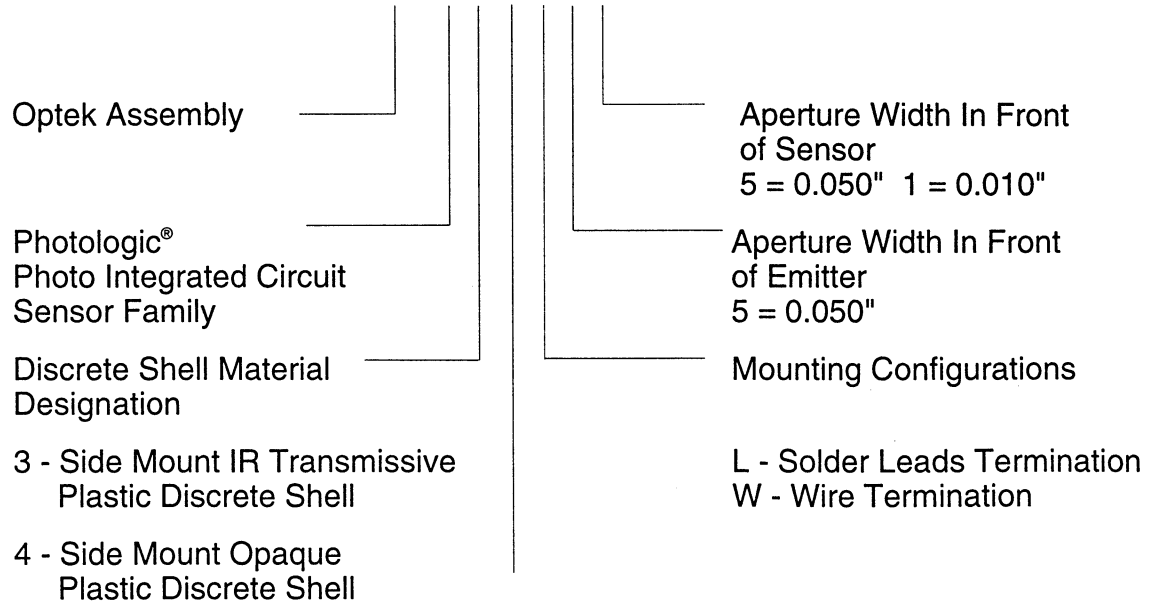

### Electrical Specification Variations

- 0 - Buffered Totem-Pole Output
- 1 - Buffered Open-Collector Output
- 2 - Inverted Totem-Pole Output
- 3 - Inverted Open-Collector Output

### Schematics

**OPB930, OPB940  
(Totem-Pole Output)  
Buffer**

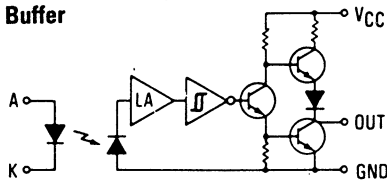

**OPB931, OPB941  
(Open-Collector Output)  
Buffer**

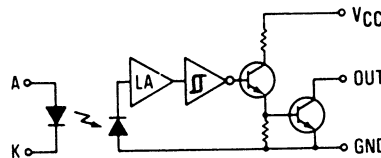

**OPB932, OPB942  
(Totem-Pole Output)  
Inverter**

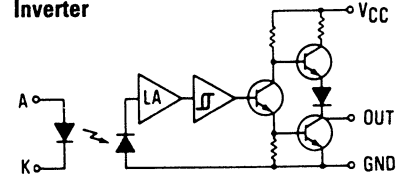

**OPB933, OPB943  
(Open-Collector Output)  
Inverter**

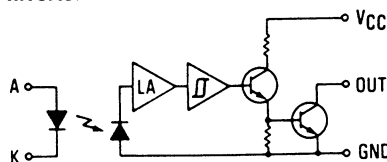

# Types OPB930L, OPB940L Series

## Typical Performance Curves

### OPB930, OPB932, OPB940, OPB942

Output Voltage vs Ambient Temperature

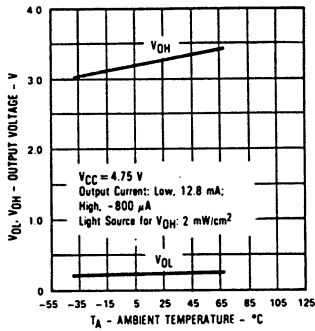

Short Circuit Output Current vs Ambient Temperature

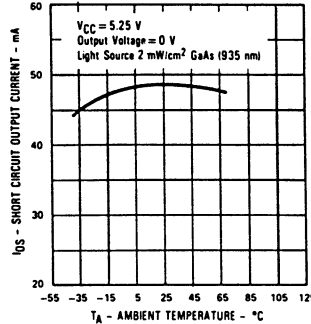

### All Assemblies

Propagation Time vs Ambient Temperature

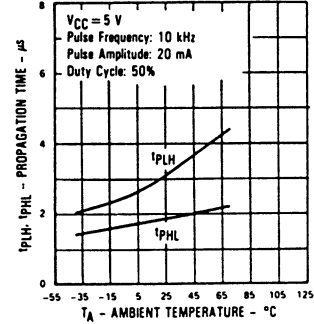

### OPB931, OPB933, OPB941, OPB943

Output Current (High) vs Ambient Temperature

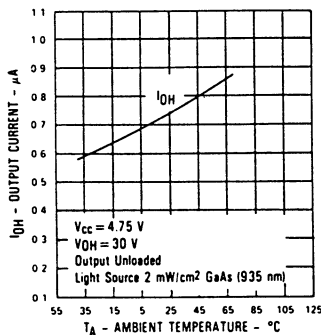

Rise Time and Fall Time vs Ambient Temperature

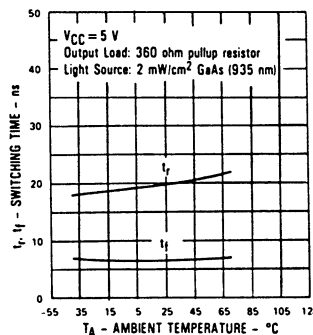

### All Assemblies

Data Rate vs Ambient Temperature

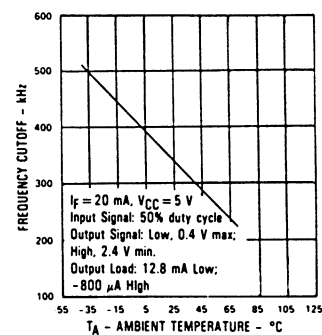

### OPB930, OPB931, OPB940, OPB941

Normalized Supply Current vs Ambient Temperature

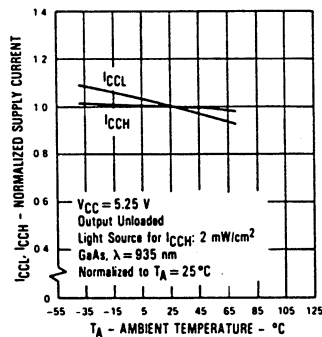

### OPB932, OPB933, OPB942, OPB943

Normalized Supply Current vs Ambient Temperature

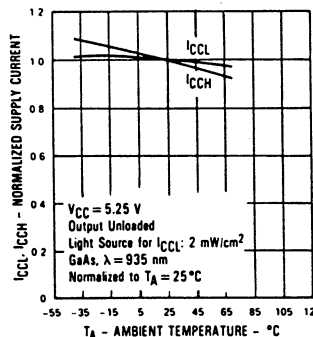

### All Assemblies

Trigger Current vs Ambient Temperature

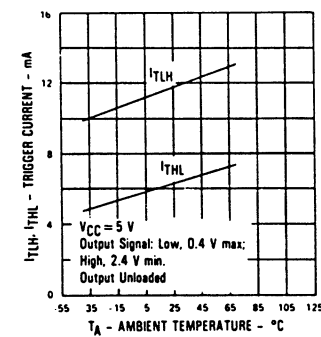

Switching Test Curve for Buffers

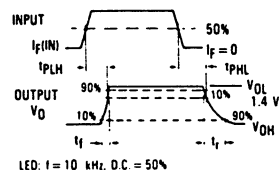

Switching Test Curve for Inverters

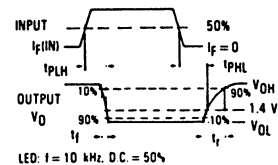

SLOTTED OPTICAL SWITCHES