



LCD Module Technical Specification

First Edition
Jan 1, 2001
Final Revision

T-51383L070J-FW-P-AA

Checked by (Quality Assurance Div.)

Checked by (Design Engineering Div.)

Prepared by (Production Div.)

Table of Contents

1. Applications.....	2
2. Features.....	2
3. Mechanical Specifications.....	2
4. Mechanical Drawing TFT LCD Module.....	3
5. Input / Output Terminals.....	4
6. Absolute Maximum Ratings.....	6
7. Electrical Characteristics.....	6
8. Power Sequence.....	15
9. Optical Characteristics.....	16
10. Handling Cautions.....	17
11. Reliability TEST.....	22
12. Block Diagram.....	23

Revision History

Rev.	Date	Page	Comment

1. Application

This technical specification applies to 7.0" color TFT-LCD module. The applications of the panel are car TV, portable DVD, GPS, multimedia applications and others AV system.

2. Features

- . Compatible with NTSC & PAL system
- . Pixel in stripe configuration
- . Slim and compact
- . High Brightness
- . Image Reversion : Up/Down and Left/Right
- . Multi Video Display Mode

3. Mechanical Specifications

Parameter	Specifications	Unit
Screen Size	7.0 (16:9 diagonal)	inch
Display Format	1440 (H) × 234(V)	dot
Active Area	154.08 (H) × 87.05 (V)	mm
Dot Pitch	0.107(H) × 0.372 (V)	mm
Pixel Configuration	Stripe	
Outline Dimension	167.1 (W)×102.0 (H)×12.0 (D)(typ.)	mm
Surface Treatment	Anti-Glare and Hard Coating	
Weight	205±10	g

4. Mechanical Drawing of TFT-LCD Module

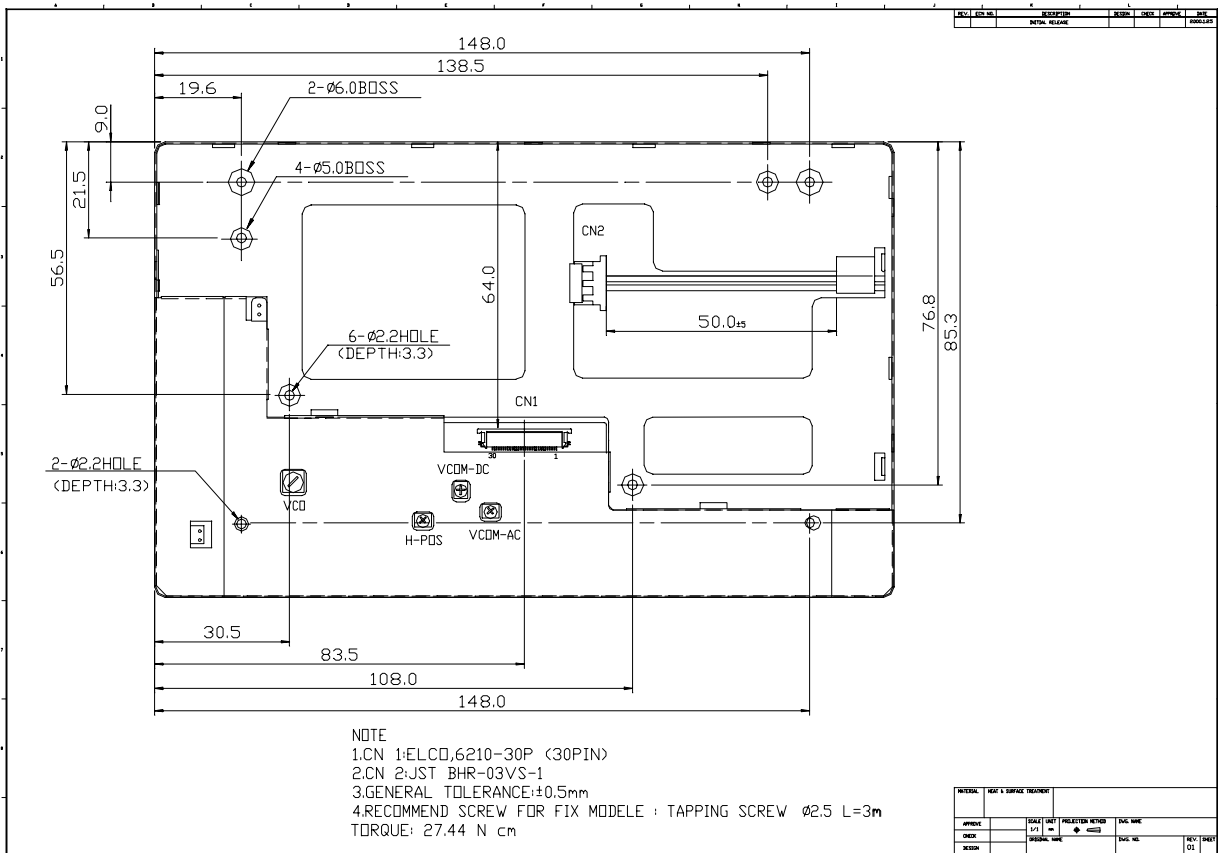
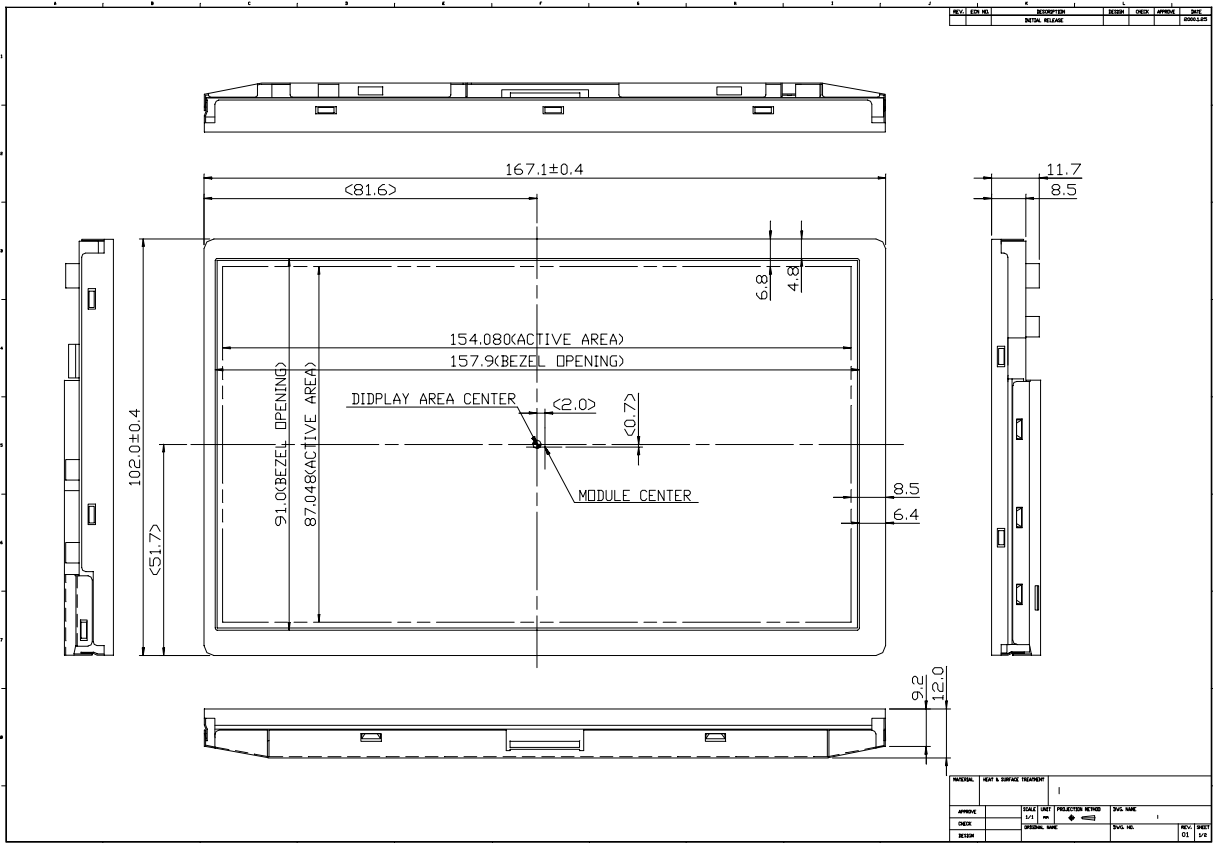

5. Input / Output Terminals

5-1) TFT-LCD Panel Driving

The interface connector is 6210-30P Series manufactured by ELCO or equivalent.
(0.5mm pitch 30 pin)

The connector interface pin assignments are listed in the Table below.

Pin No	Symbol	I/O	Description	Remark
1	PSI	O	Synchronize Pulse for Decoder	
2	VR	I	Red Video Input	
3	VG	I	Green Video Input	
4	VB	I	Blue Video Input	
5	GND	I	Ground	
6	CSY	I	Composite Sync Input	
7	NC		No Connection	
8	NC		No Connection	
9	NC		No Connection	
10	NC		No Connection	
11	MODE 1	I	Display mode selection pin 1 (refer to 5.2)	
12	MODE 2	I	Display mode selection pin 2 (refer to 5.2)	
13	MODE 3	I	Display mode selection pin 3 (refer to 5.2)	
14	GND	I	Ground	
15	BLK	O	Video Signal Mask Timing Output	
16	HSY	O	Horizontal Sync Output	
17	VSY	O	Vertical Sync Output	
18	VDD	I	Input Voltage For Logic/Logic Voltage For Source Driver	
19	NC		No Connection	
20	FRP	O	Video Polarity Control Signal	
21	GND	I	Ground	
22	U/D	I	Scanning Direction : (Low : Normal , High : Reverse)	
23	L/R	I	Scanning Direction : (Low : Normal , High : Reverse)	
24	N/P	I	NTSC/PAL Selection Signal(Low : PAL , High : NTSC)	
25	NC		No Connection	
26	NC		No Connection	
27	GND	I	Ground	
28	VCC	I	Analog Voltage For Source Driver/Logic Voltage For Gate	
29	VGH	I	Positive Voltage For Gate Driver	
30	VGL	I	Negative Voltage For Gate Driver	

5.2) Display Mode

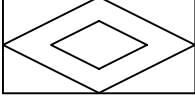
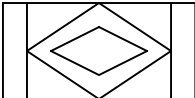
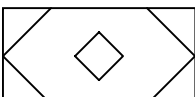
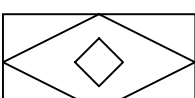
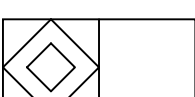
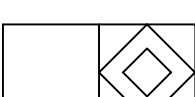
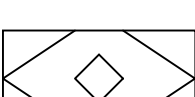
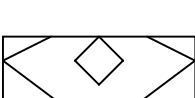
Display Mode	Display (Input Signal of 4:3 Aspect Ratio)	NO:11	NO:12	NO:13	Note
		Mode 1	Mode 2	Mode 3	
Full		Low	Low	Low	Input Video Signals Are Displayed In Full Screen.
Normal Center		High	Low	Low	Input Video Signals Are Displayed In The Center Screen.(4:3 Aspect Ratio)
Zoom 1		High	High	Low	Input Video Signal Of Central 176 Lines Are Display In Full Screen.(Vertically Extension)
Wide		Low	High	Low	Input Video Signals Are Displayed In Full Screen.(Horizontal Modification)
Normal Left		High	Low	High	Input Video Signals Are Display In the Left Screen.(4:3 Aspect Ratio)
Normal Right		Low	High	High	Input Video Signals Are Display In the Right Screen.(4:3 Aspect Ratio)
Zoom 2		Low	Low	High	Input Video Signal Of Central 204 Lines Are Display In Full Screen.(Vertically Extension)
Zoom 3		High	High	High	Same As Zoom 2 Mode Vertically Offset Centered

6 Absolute Maximum Ratings:

The followings are maximum values , which if exceeded, may cause faulty operation or damage to the unit.

Parameter	Symbol	MIN.	MAX.	Unit	Remark	
Supply Voltage For Source Driver	V _{CC}	-0.5	7	V		
	V _{DD}	-0.5	7	V		
Supply Voltage For Gate Driver	V _{GH} - V _{GL}	-0.3	40	V		
	H Level	V _{GH}	0	40	V	
	L Level	V _{GL}	-20	0	V	
Analog Signal Input Level	V _R ,V _G ,V _B	-0.3	7.0	V	Note 6-1	
Digital Input Signals		-0.3	5.5	V		
Digital Output Signals		-0.3	5.5	V		
Storage Temperature		-30	+80			
Operation Temperature		-20	+70		Note 6-2	

Notes:6-1 Analog Input Voltage means V_R,V_G,V_B.

Notes:6-2 Operating Temperature define that contrast, response time, other display optical character are T_a=+25.

7 Electrical Characteristics

7-1) Recommended Driving condition for TFT-LCD panel

Parameter		Symbol	MIN.	Typ	MAX	Unit	Remark
Supply Voltage For Source Driver	Analog	V _{CC}	4.5	5.0	5.5	V	
	Logic	V _{DD}	4.5	5.0	5.5	V	
Supply Voltage For Gate Driver	H level	V _{GH}	+15	+17	+19	V	
	L level	V _{GL}	-16	-15	-14	V	
Supply Voltage For controller		V _{DD}	4.5	5.0	5.5	V	
Analog Signal input Level	Amplitude		0.3		V _{CC} -0.3	V	
Digital input voltage	H level	V _{IN}	0.7	-	V _{DD}	V	
	L level	V _{IL}	-0.3	-	0.3 V _{DD}	V	
Digital output voltage	H level	V _{OH}	0.7	-	V _{DD}	V	
	L level	V _{OL}	-0.3	-	0.3 V _{DD}	V	

7-2) Backlight driving & Power Consumption

Pin No	Symbol	Description	Remark
1	VL1	Input terminal (Hi voltage side)	Wire color: pink
2	NC	No Connection	
3	VL2	Input terminal (Low voltage side)	Wire color: white Note 7-1

Note 7-1 : Low voltage side of backlight inverter connects with Ground of inverter circuits.

Recommended Driving condition for backlight

Ta= 25

Parameter	Symbol	Min.	Typ.	Max.	Unit	Remark
Lamp voltage	V_L		810		Vrms	$I_L=6mA$
Lamp current	I_L	4.5	6	7	mA	
Lamp frequency	P_L	35		60	KHz	Note 7-2
Kick-off voltage(25)	V_s	TBD	TBD	1095	Vrms	Note 7-3
Kick-off voltage(0)	V_s	TBD	TBD	1340	Vrms	Note 7-3

Note 7-2 : The waveform of lamp driving voltage should be as closed to a perfect sine wave as possible.

Note 7-3 : The Kick-off times 1sec.

Power Consumption

Ta= 25

Parameter	Symbol	Conditions	TYP.	MAX	Unit	Remark
Supply current for Gate Driver (Hi level)	I_{GH}	$V_{GH} = +17V$	0.15	0.2	mA	
Supply current for Gate Driver (Low level)	I_{GL}	$V_{GL} = -15V$	20	50	mA	
Supply current for Source Driver	I_{CC}	$V_{CC} = +5V$	20	30	mA	
Supply current for controller	I_{DD}	$V_{DD} = +5V$	20	30	mA	
LCD Panel Power Consumption			0.50		W	Note 7-4
Backlight Lamp Power Consumption			4.86		W	Note 7-5

Note 7-4 : The power consumption for backlight is not included.

Note 7-5 : Backlight lamp power consumption is calculated by $I_L \times V_L$.

7-4) Input / Output Connector

A) LCD Module Connector

The interface connector is 6210-30p Series manufactured by Elco or equivalent (0.5mm pitch 30pin)

B) Backlight Connector, JST BHR-03VS-1. Pin No. : 3, Pitch : 4 mm

7-5) Pixel Arrangement and Output Interface Pin

	1	2	3	4	5	6		1438	1439	1440
1	R	G	B	R	G	B		R	G	B
2	R	G	B	R	G	B		R	G	B
3	R	G	B	R	G	B		R	G	B
233	R	G	B	R	G	B		R	G	B
234	R	G	B	R	G	B		R	G	B

7-6)Signal Timing Waveforms

Timing Specification [Horizontal]

Parameter	Symbol	Condition	NTSC	PAL	Unit	Notes
Horizontal Start Position	HPOS	-	11.35	11.54	usec	Note7-6
Horizontal Display Area	HDIS	-	50.01	50.36	usec	

Notes :7-6

1. Sampling start based on the composite sync falling edge.
2. This value is default , if you want to charge ,please contact PVI.

[Vertical]

Parameter	Symbol	Condition	Display Mode					Unit	Notes	
			Full Normal	Wide	Zoom 1	Zoom 2	Zoom 3			
Vertical Start Position	VPOS	NTSC	ODD 22	22	52	38	53	Line	Note 7-7	
		EVEN	286	286	315	301	315			
Vertical Start Position	VPOS	PAL	ODD 26	26	62	50	62	Line	Note 7-7	
		EVEN	339	363	375	363	375			
Vertical Display Position	VDIS	NTSC		234	234	176	204	204	Line	
		PAL		281	281	210	234	234	Line	

Notes :7-7 Sampling start line number base on the vertical sync pulse (SYNC).

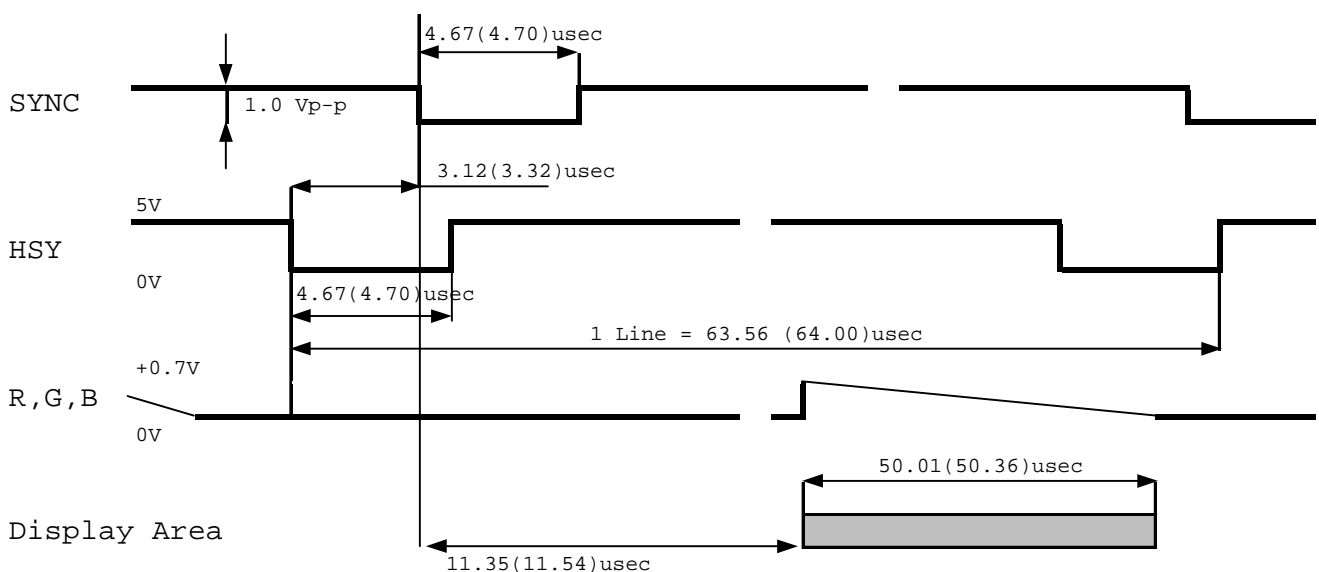

Note:7-7 Values in brackets correspond to PAL mode (f_H=15.734(15.625)KHz).

7-7) Display Time Range

A) When sync. signal of NTSC system is applied.

a) Horizontally

11.35 ~ 61.36 μ s.

b) Vertical

22 ~ 255 H

B) When sync. signal of PAL system is applied.

a) Horizontally

11.54 ~ 61.9 μ s

b) Vertical

28 ~ 300 H

C) NTSC System Timing Reference

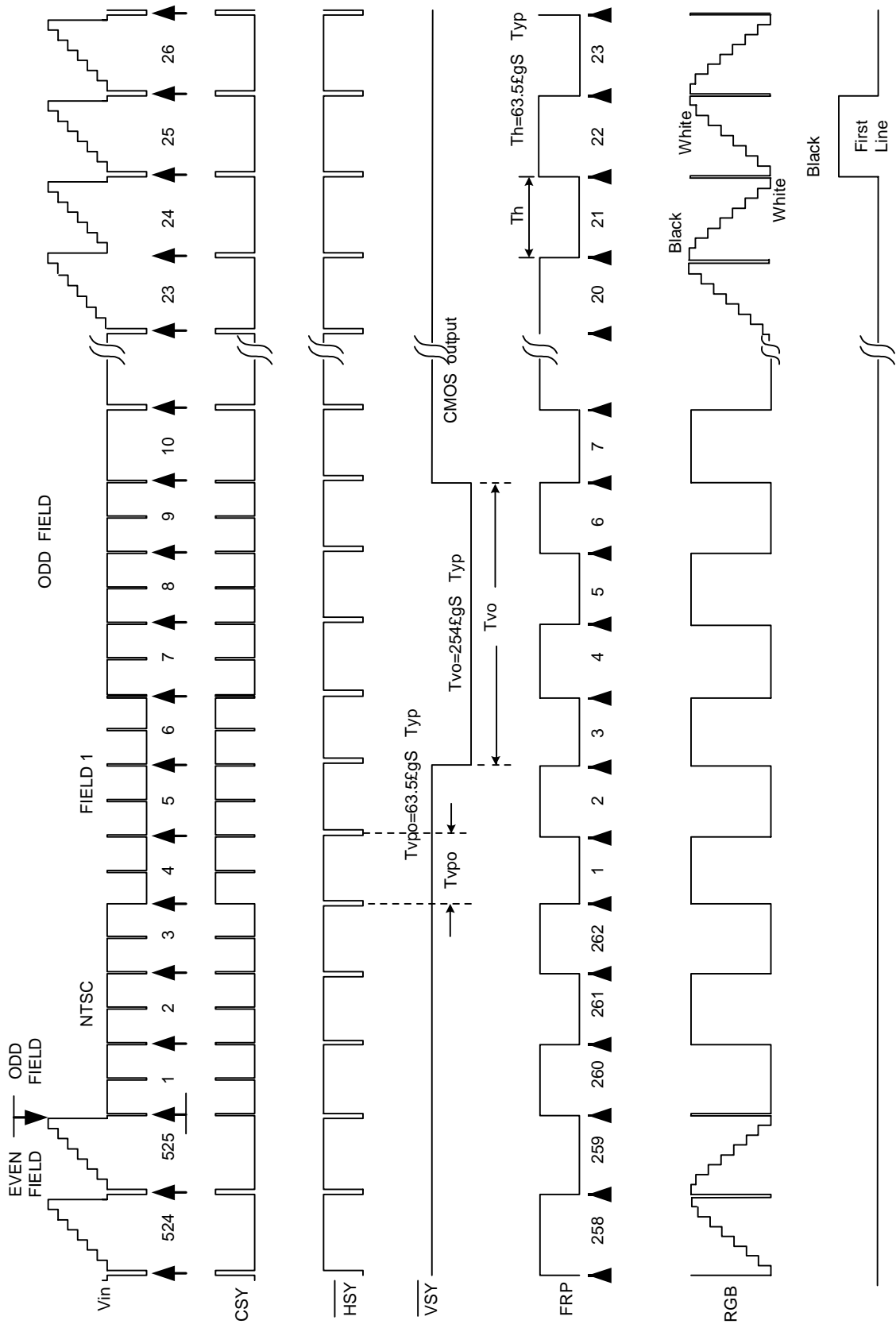

Timing chart of I/O and RGB signal

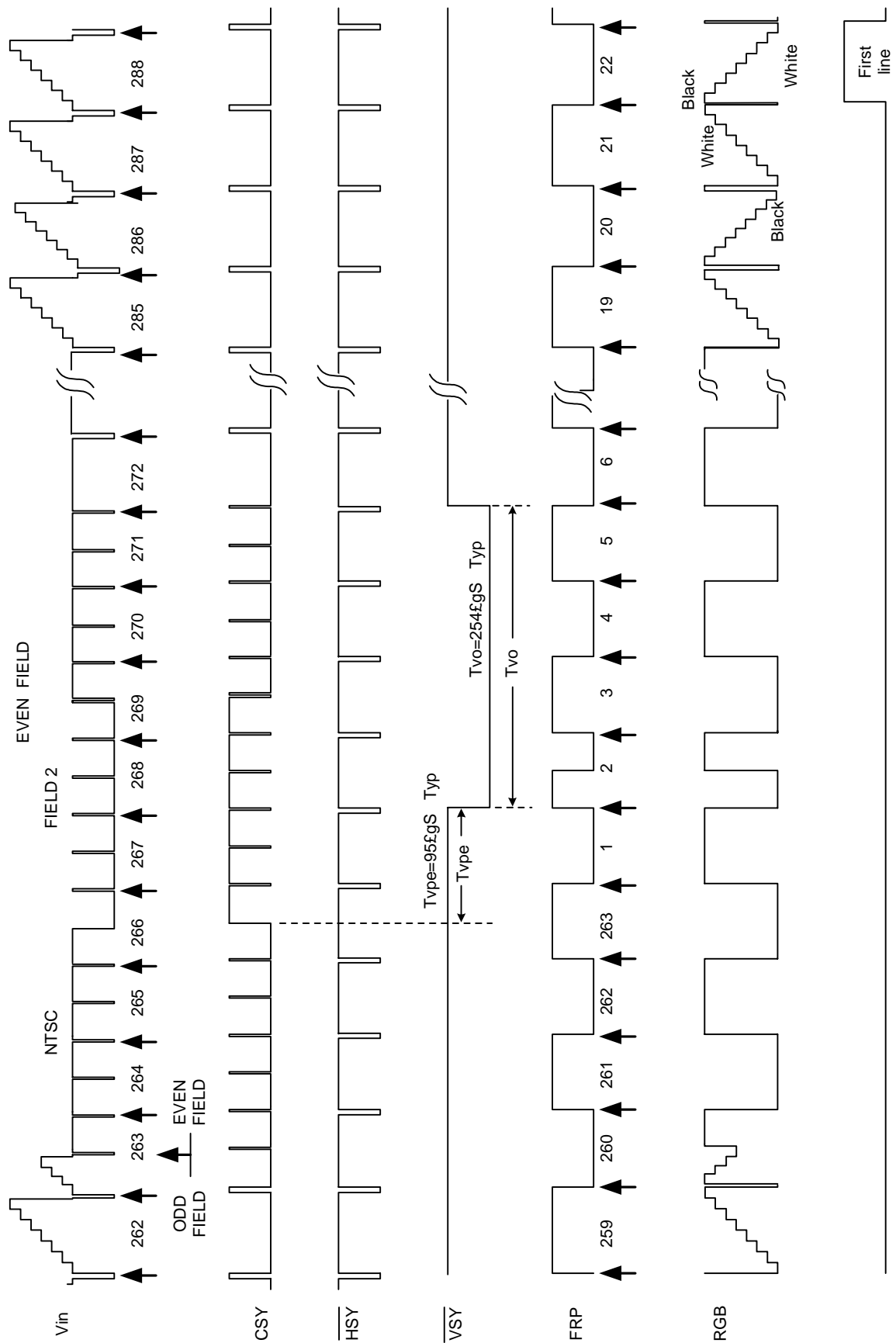

Timing chart of I/O and RGB signal

D) PAL System Timing Reference

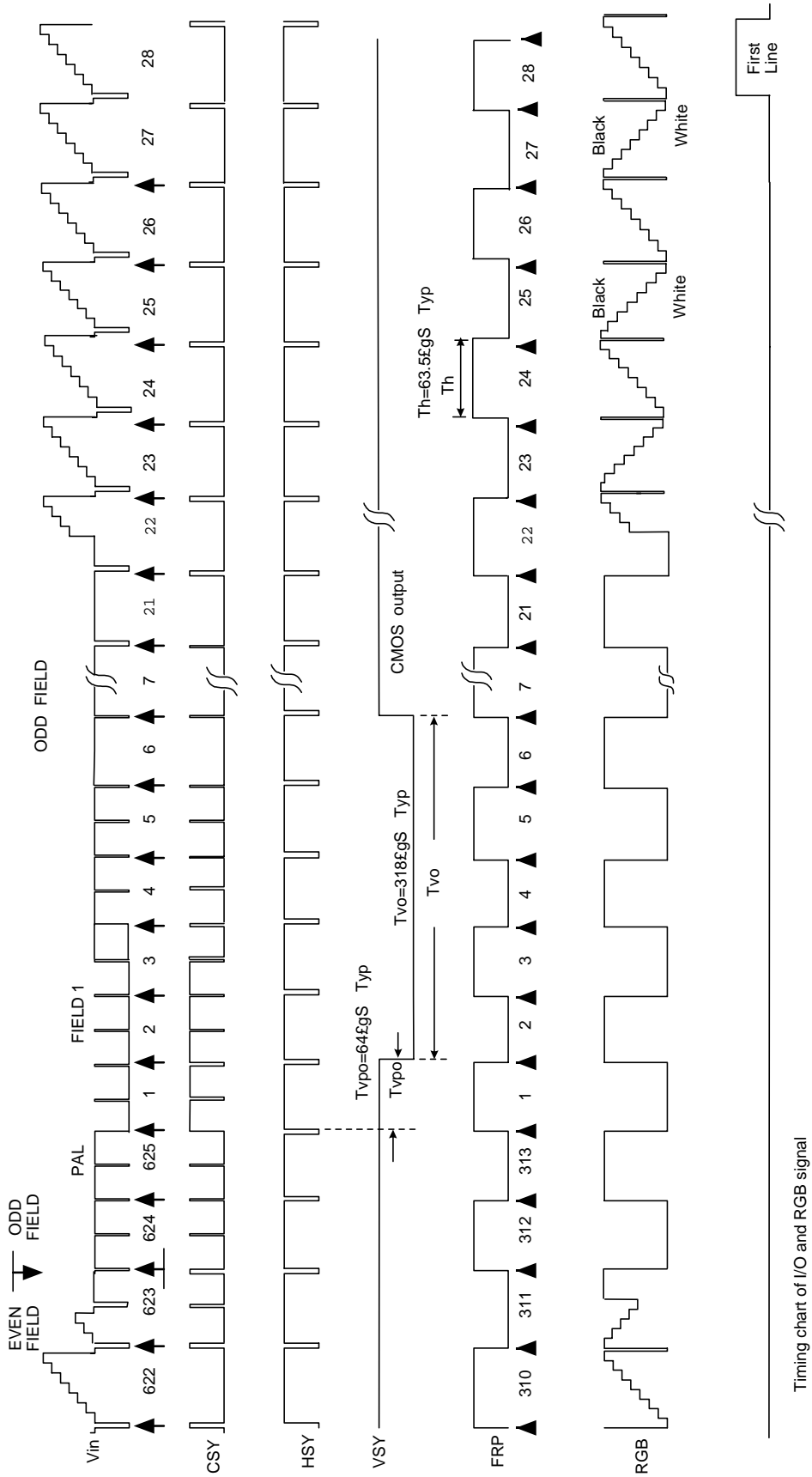

Timing chart of I/O and RGB signal

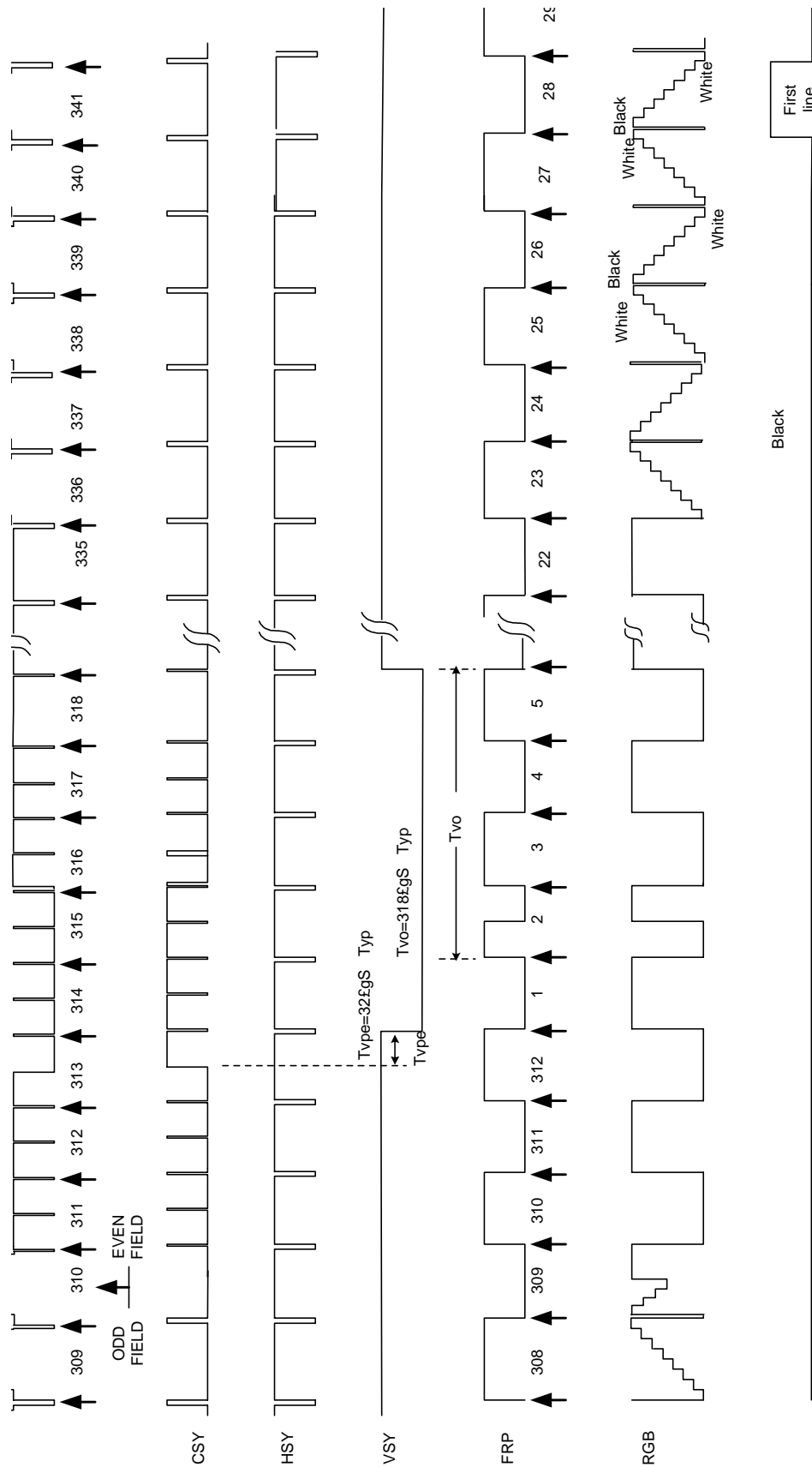

Timing chart of I/O and RGB signal

E) Display Timing (NTSC)

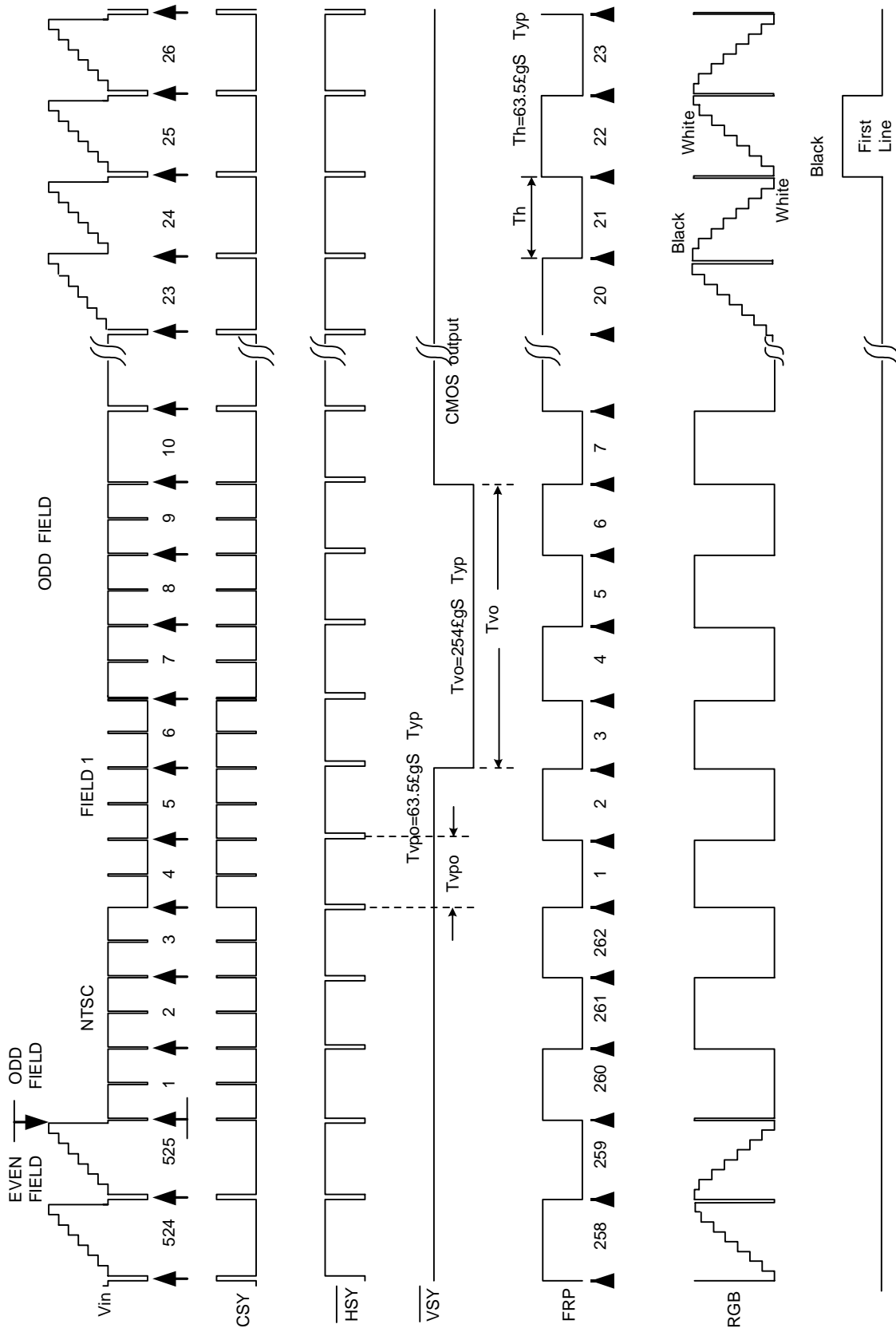

Timing chart of I/O and RGB signal

F) Display Timing (PAL)

Sampling Clock: 9.53MHz

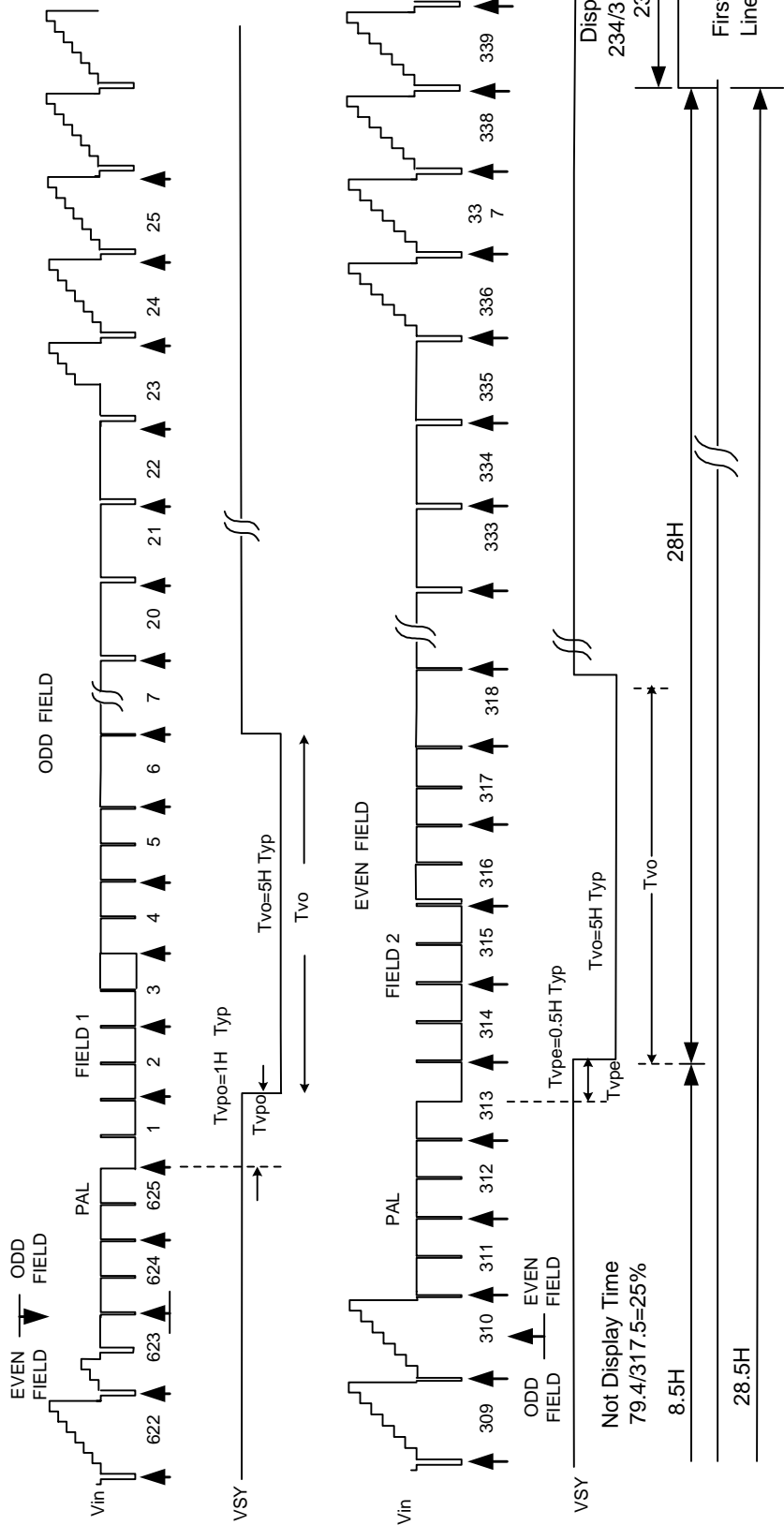
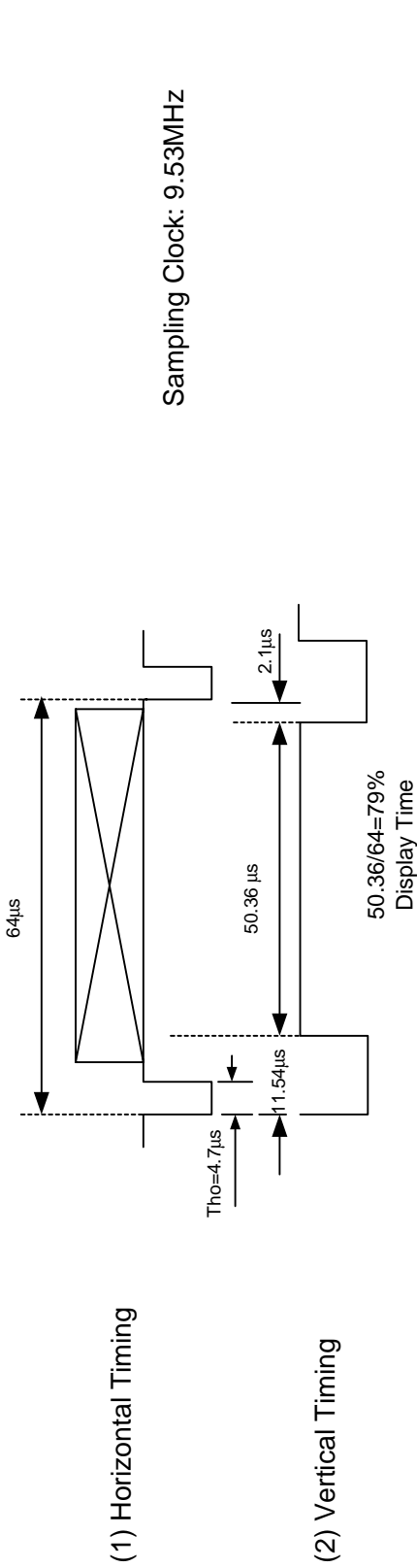

8. Power Sequence

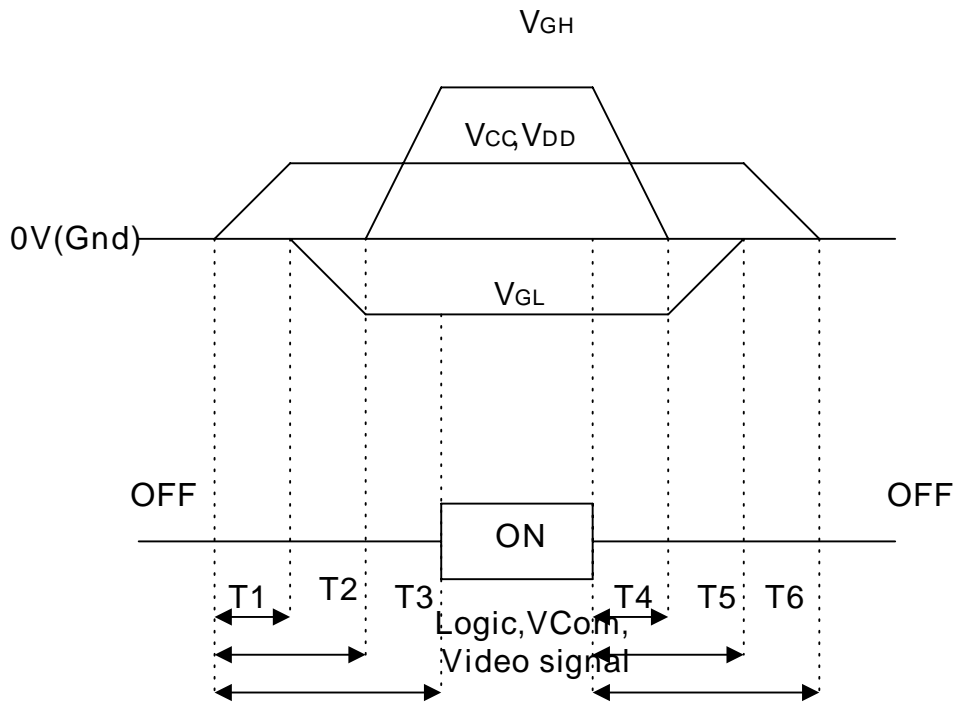

- 1) 10ms T_1 T_2 T_3
- 2) 10ms T_4 T_5 T_6

9. Optical Characteristics

9-1) Specification:

Ta = 25

Parameter		Symbol	Condition	MIN.	TYP.	MAX.	Unit	Remarks
Viewing Angle	Horizontal	21, 22	CR 10	45	55		deg	Note 9-1
	Vertical	12		10	15		deg	Note 9-1
		11		30	35		deg	Note 9-1
Contrast Ratio		CR		70	150			Note 9-2
Response time	Rise	Tr	=0°			30	ms	Note 9-4
	Fall	Tf				50	ms	
Brightness				350	400		cd/m ²	Note 9-3
White Chromaticity		x			0.285			Note 9-3
		y			0.295			
Lamp Life Time +25				10,000			hr	

Note 9-1: The definitions of viewing angles

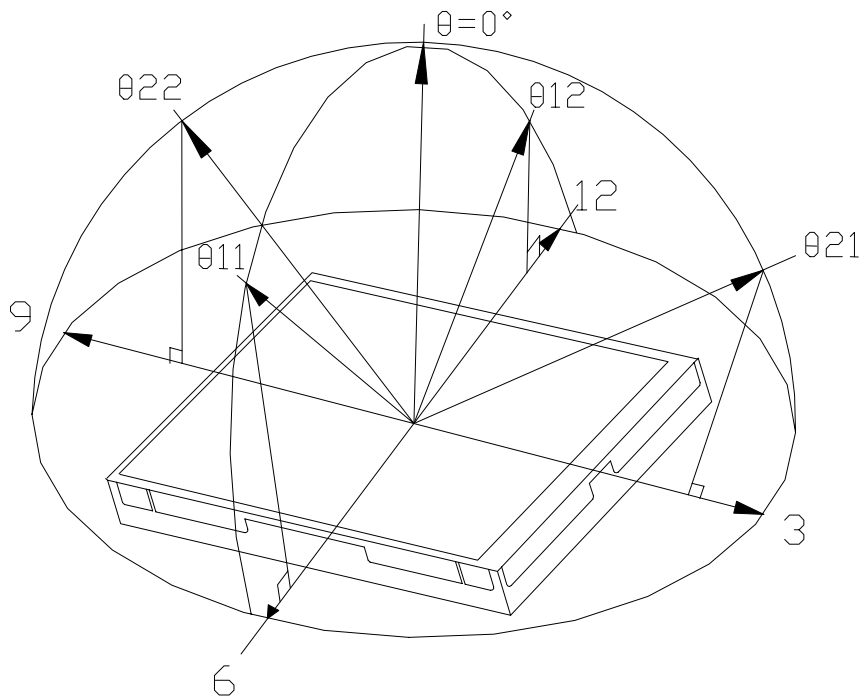

Note 9-2 : CR = $\frac{\text{Luminance when Testing point is White}}{\text{Luminance when Testing point is Black}}$
(Testing configuration see 8-2)

Contrast Ratio is measured in optimum common electrode voltage.

Note 9-3 : Topcon BM-7(fast) luminance meter 2 ° field of view is used in the testing (after 20~30 minutes operation).

Lamp Current 6mA

Note 9-4: The definition of response time:

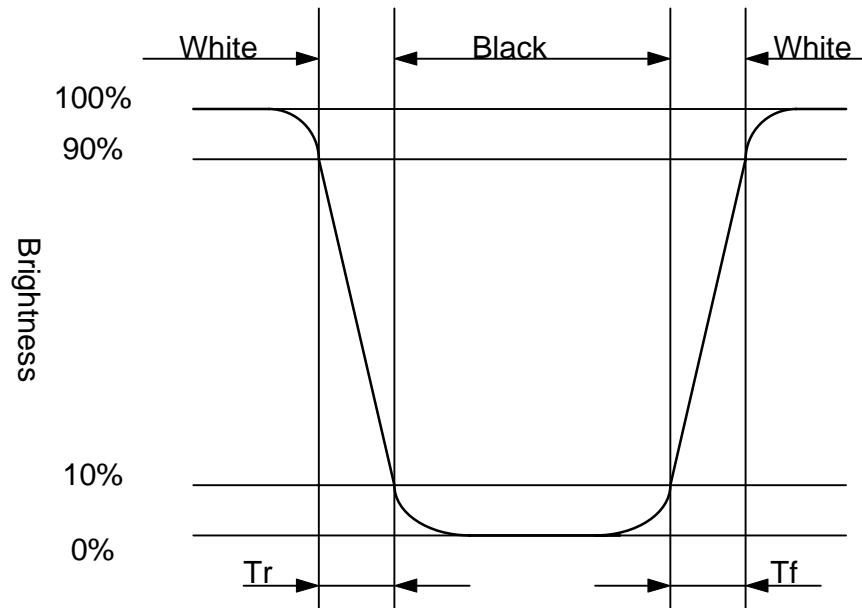

9-2) Testing configuration

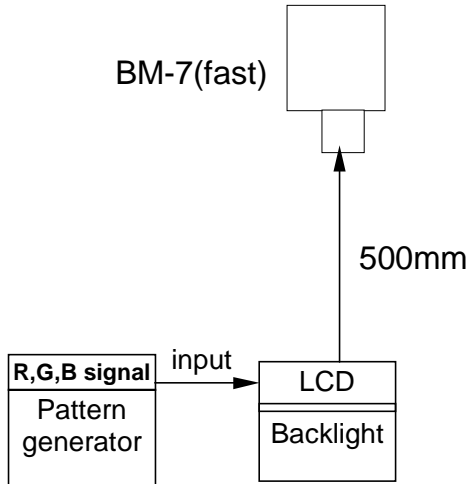

Caution: 1. Environmental illumination 1 lux
 2. Before test CR, Vcom voltage must be adjusted carefully to get the best CR.

- LCD Display Testing Point Testing Point

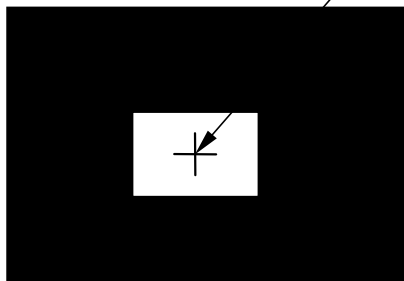

Pattern A

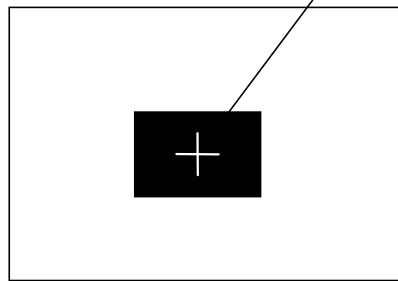

Pattern B

- R, G, B Waveform of Pattern A at Testing Point

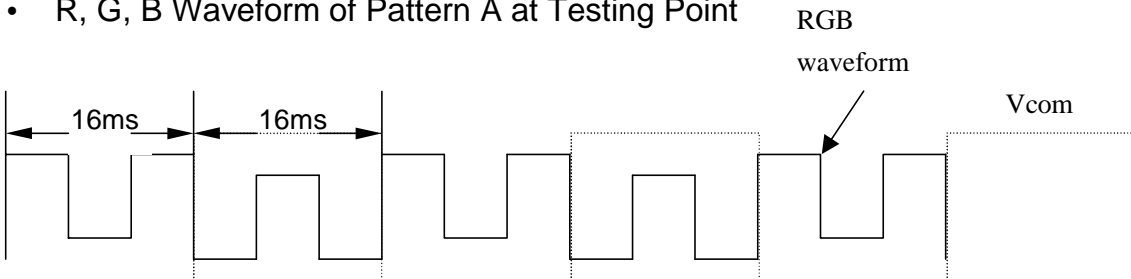

- R, G, B Waveform of Pattern B at Testing Point

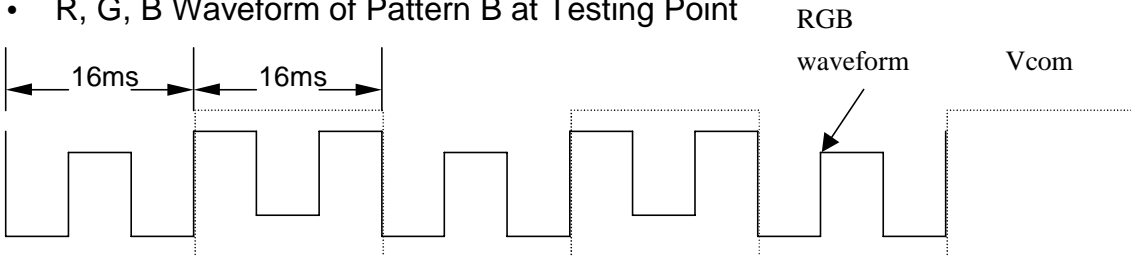

10. Handling Cautions

10-1) Mounting of module

- a) Please power off the module when you connect the input/output connector.
- b) Please connect the ground pattern of the inverter circuit surely. If the connection is not perfect, some following problems may happen possibly.
 - 1. The noise from the backlight unit will increase.
 - 2. The output from inverter circuit will be unstable.
 - 3. In some cases a part of module will heat.
- c) Polarizer which is made of soft material and susceptible to flaw must be handled carefully.
- d) Protective film (Laminator) is applied on surface to protect it against scratches and dirt. It is recommended to peel off the laminator before use and taking care of static electricity.

10-2) Precautions in mounting

- a) When metal part of the TFT-LCD module (shielding lid and rear case) is soiled, wipe it with soft dry cloth.
- b) Wipe off water drops or finger grease immediately. Long contact with water may cause discoloration or spots.
- c) TFT-LCD module uses glass which breaks or cracks easily if dropped or bumped on hard surface. Please handle with care.
- d) Since CMOS LSI is used in the module. So take care of static electricity and earth yourself when handling.

10-3) Adjusting module

- a) Adjusting volumes on the rear face of the module have been set optimally before shipment.
- b) Therefore, do not change any adjusted values. If adjusted values are changed, the specifications described may not be satisfied.

10-4) Others

- a) Do not expose the module to direct sunlight or intensive ultraviolet rays for many hours.
- b) Store the module at a room temperature place.
- c) The voltage of beginning electric discharge may over the normal voltage because of leakage current from approach conductor by to draw lump read lead line around.
- d) If LCD panel breaks, it is possible that the liquid crystal escapes from the panel. Avoid putting it into eyes or mouth. When liquid crystal sticks on hands, clothes or feet. Wash it out immediately with soap.
- e) Observe all other precautionary requirements in handling general electronic components.
- f) Please adjust the voltage of common electrode as material of attachment by 1 module.

11. Reliability Test

No	Test Item	Test Condition
1	High Temperature Storage Test	Ta = +80 , 240 hrs
2	Low Temperature Storage Test	Ta = -30 , 240 hrs
3	High Temperature Operation Test	Ta = +70 , 240 hrs
4	Low Temperature Operation Test	Ta = -20 , 240 hrs
5	High Temperature & High Humidity Operation Test	Ta = +60 , 95%RH, 240 hrs
6	Thermal Cycling Test (non-operating)	-25 +25 +70 , 200 Cycles 30 min 5min 30 min
7	Vibration Test (non-operating)	Frequency : 10 ~ 55 Hz Amplitude : 1.5 mm Sweep time: 11 mins Test Period: 6 Cycles for each direction of X, Y, Z
8	Shock Test (non-operating)	100G, 6ms Direction: ± X, ± Y, ± Z Cycle: 3 times
9	Electrostatic Discharge Test (non-operating)	150pF, 330 Air: ±15KV; Contact: ±8KV 10 times/point, 9 points/panel face

Ta: ambient temperature

[Criteria]

Under the display quality test conditions with normal operation state, there should be no change which may affect practical display function.

11. Block Diagram

