

UF1000F THRU UF1008F

ULTRAFAST SWITCHING RECTIFIER

VOLTAGE - 50 to 800 Volts CURRENT - 10.0 Amperes

ITO-220AC

FEATURES

- Plastic package has Underwriters Laboratory Flammability Classification 94V-O Utilizing Flame Retardant Epoxy Molding Compound
- Exceeds environmental standards of MIL-S-19500/228
- Low power loss, high efficiency
- Low forward voltage, high current capability
- High surge capacity
- Ultra Fast recovery times, high voltage

MECHANICAL DATA

Case: ITO-220AC full molded plastic package

Terminals: Lead solderable per MIL-STD-202, Method 208

Polarity: As marked

Mounting Position: Any

Weight: 0.08 ounce, 2.24 gram

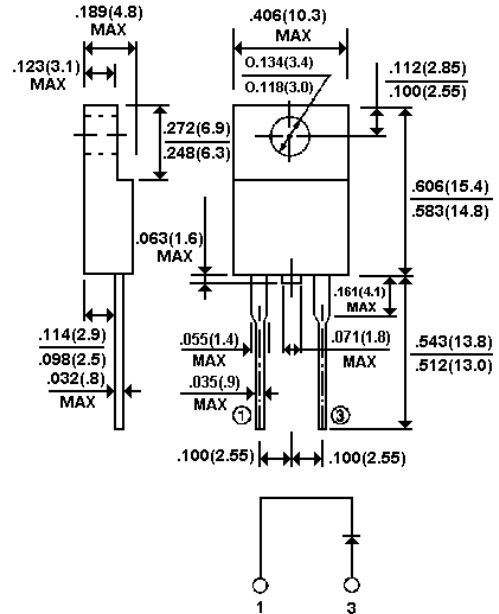

Dimensions in inches and (millimeters)

MAXIMUM RATINGS AND ELECTRICAL CHARACTERISTICS

Ratings at 25 °C ambient temperature unless otherwise specified.

Single phase, half wave, 60Hz, resistive or inductive load.

For capacitive load, derate current by 20%

TYPE NUMBER	UF1000F	UF1001F	UF1002F	UF1003F	UF1004F	UF1006F	UF1008F	UNITS
Maximum Recurrent Peak Reverse Voltage	50	100	200	300	400	600	800	V
Maximum RMS Voltage	35	70	140	210	280	420	560	V
Maximum DC Blocking Voltage	50	100	200	300	400	600	800	V
Maximum Average Forward Rectified Current .375"(9.5mm) lead length @ T _C =100 °C	10.0							A
Peak Forward Surge Current, 8.3ms single half sine wave superimposed on rated load(JEDEC method)	150							A
Maximum Instantaneous Forward Voltage at 10.0A	1.0		1.3		1.7			V
Maximum DC Reverse Current @ T _A =25 °C	10.0							µg A
at Rated DC Blocking Voltage @ T _A =125 °C	500							µg A
Maximum Reverse Recovery Time(Note 1)	50					100		ns
Typical Junction capacitance (Note 2)	80					50		pF
Typical Junction Resistance (Note 2) R _{θJKJA}	15							°C/W
Operating and Storage Temperature Range T _J , T _{STG}	-50 to +150							°C

NOTES:

1. Reverse Recovery Test Conditions: I_F=0.5A, I_R=1A, I_{rr}=0.25A
2. Measured at 1 MHz and applied reverse voltage of 4.0 VDC
3. Thermal resistance from junction to ambient and from junction to lead length 0.375"(9.5mm) P.C.B. mounted

RATING AND CHARACTERISTIC CURVES UF1000F THRU UF1008F

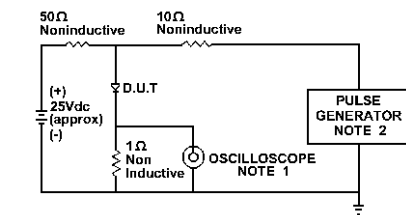

NOTE:1. Rise Time = 7ns max.
Input Impedance = 1 megohm. 22pF
2. Rise Time = 10ns max.
Source Impedance = 50 Ohms

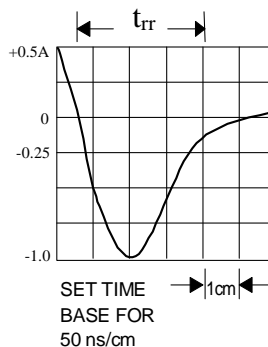

Fig. 1-REVERSE RECOVERY TIME CHARACTERISTIC AND TEST CIRCUIT DIAGRAM

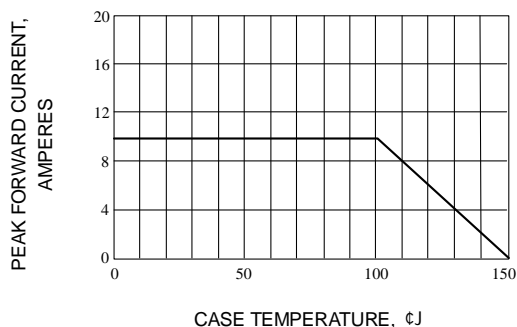

Fig. 1-TYPICAL FORWARD CURRENT DERATING CURVE

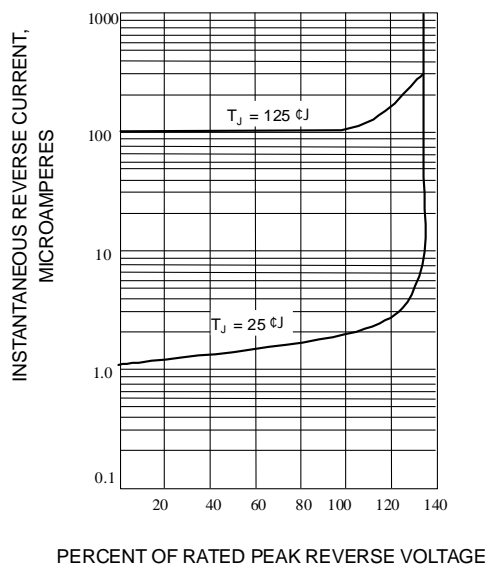

Fig. 2-TYPICAL REVERSE CHARACTERISTICS

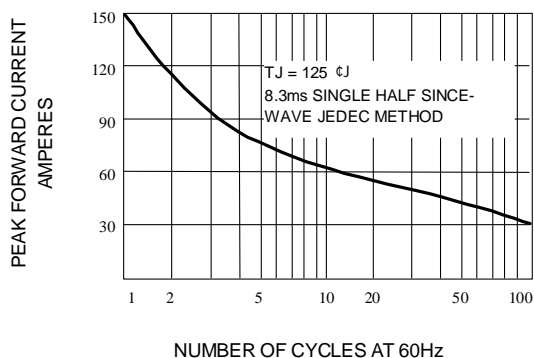

Fig. 3-MAXIMUM NON-REPETITIVE FORWARD SURGE CURRENT

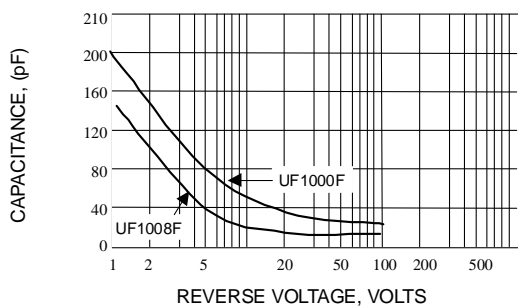

Fig. 4-TYPICAL JUNCTION CAPACITANCE

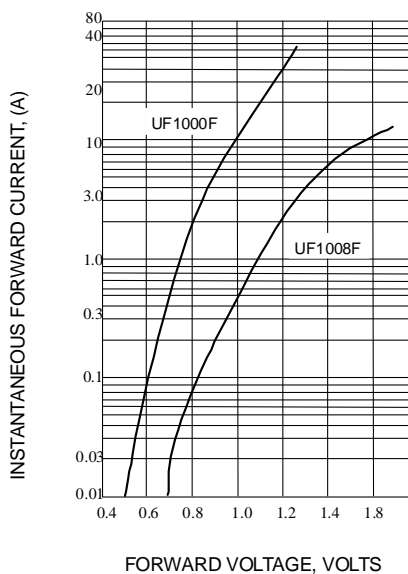

Fig. 5-TYPICAL FORWARD CHARACTERISTICS