

# 2SB1553

Silicon PNP epitaxial planar type

For power amplification

## Features

- High forward current transfer ratio  $h_{FE}$
- Satisfactory linearity of forward current transfer ratio  $h_{FE}$
- Allowing automatic insertion with radial taping

## Absolute Maximum Ratings ( $T_C=25^\circ\text{C}$ )

Parameter	Symbol	Rated	Unit
Collector to base voltage	$V_{CBO}$	-60	V
Collector to emitter voltage	$V_{CEO}$	-60	V
Emitter to base voltage	$V_{EBO}$	-6	V
Peak collector current	$I_{CP}$	-6	A
Collector current	$I_C$	-3	A
Base current	$I_B$	-1	A
Collector power dissipation	$P_C$	15	W
		2	
Junction temperature	$T_j$	150	$^\circ\text{C}$
Storage temperature	$T_{stg}$	-55 to +150	$^\circ\text{C}$

## Electrical Characteristics ( $T_C=25^\circ\text{C}$ )

Parameter	Symbol	Conditions	min	typ	max	Unit
Collector cutoff current	$I_{CBO}$	$V_{CB} = -60\text{V}, I_E = 0$			-100	$\mu\text{A}$
	$I_{CEO}$	$V_{CE} = -40\text{V}, I_B = 0$			-100	$\mu\text{A}$
Emitter cutoff current	$I_{EBO}$	$V_{EB} = -6\text{V}, I_C = 0$			-100	$\mu\text{A}$
Collector to emitter voltage	$V_{CEO}$	$I_C = -25\text{mA}, I_B = 0$	-60			V
Forward current transfer ratio	$h_{FE}^*$	$V_{CE} = -4\text{V}, I_C = -0.5\text{A}$	300		700	
Collector to emitter saturation voltage	$V_{CE(sat)}$	$I_C = -2\text{A}, I_B = -0.05\text{A}$			-1	V
Transition frequency	$f_T$	$V_{CE} = -12\text{V}, I_C = -0.2\text{A}, f = 10\text{MHz}$		30		MHz

\* $h_{FE}$  Rank classification

Rank	Q	P
$h_{FE}$	300 to 500	400 to 700

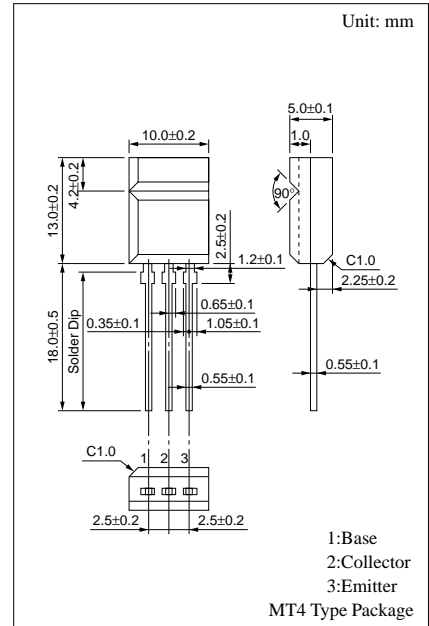

$P_C - T_a$

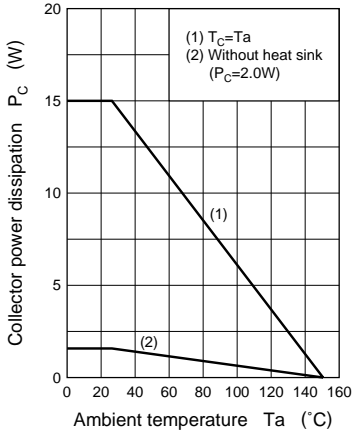

$I_C - V_{CE}$

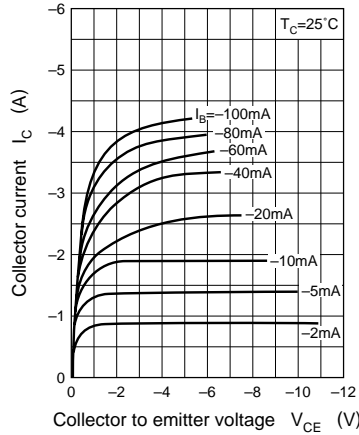

$I_C - V_{BE}$

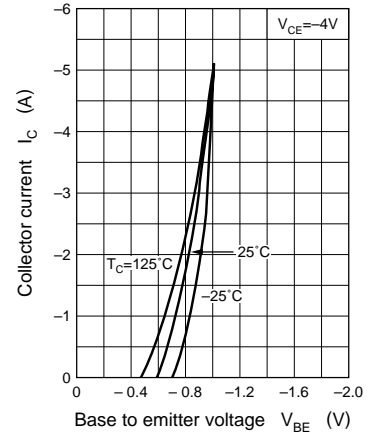

$V_{CE(sat)} - I_C$

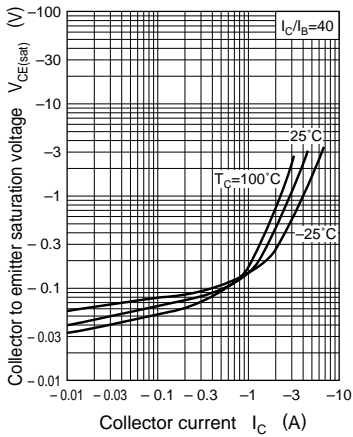

$h_{FE} - I_C$

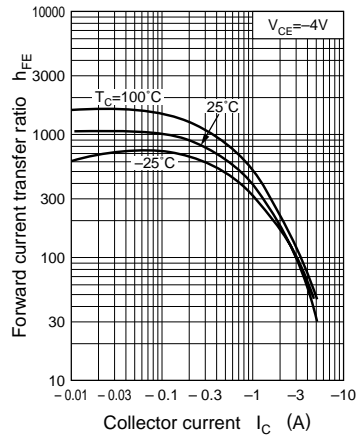

$f_T - I_C$

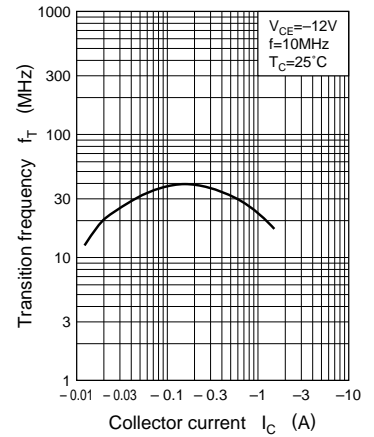

$C_{ob} - V_{CB}$

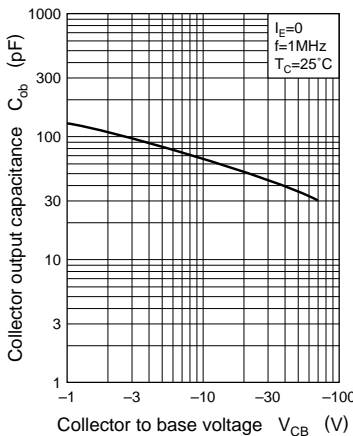

$t_{on}, t_{stg}, t_f - I_C$

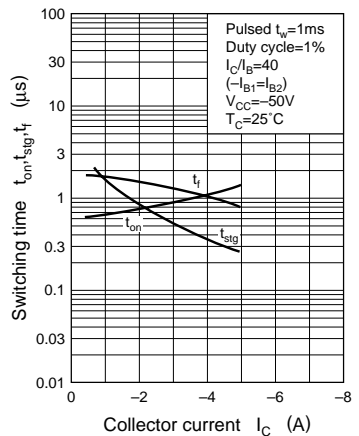

Area of safe operation (ASO)

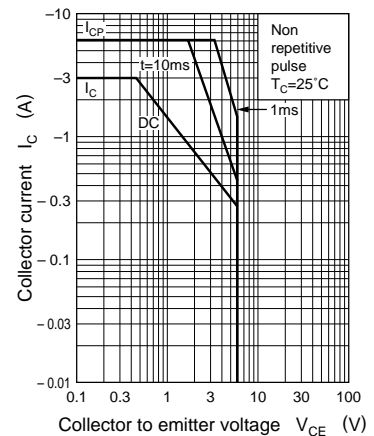

$$R_{th(t)} - t$$

