

# LN58

## GaAs Infrared Light Emitting Diode

For optical control systems

### ■ Features

- High-power output, high-efficiency :  $P_O = 3.5 \text{ mW}$  (typ.)
- Emitted light spectrum suited for silicon photodetectors
- Infrared light emission close to monochromatic light :  
 $\lambda_p = 950 \text{ nm}$  (typ.)
- Small size, thin side-view type package

### ■ Absolute Maximum Ratings ( $T_a = 25^\circ\text{C}$ )

Parameter	Symbol	Ratings	Unit
Power dissipation	$P_D$	75	mW
Forward current (DC)	$I_F$	50	mA
Pulse forward current	$I_{FP}^*$	1	A
Reverse voltage (DC)	$V_R$	3	V
Operating ambient temperature	$T_{opr}$	-25 to +85	$^\circ\text{C}$
Storage temperature	$T_{stg}$	-30 to +100	$^\circ\text{C}$

\*  $f = 100 \text{ Hz}$ , Duty cycle = 0.1 %

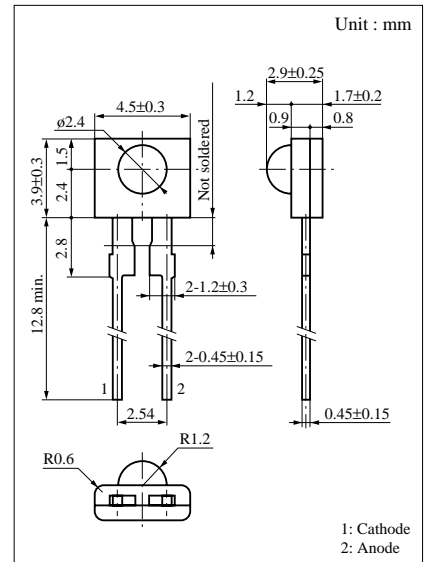

### ■ Electro-Optical Characteristics ( $T_a = 25^\circ\text{C}$ )

Parameter	Symbol	Conditions	min	typ	max	Unit
Radiant power	$P_O$	$I_F = 50 \text{ mA}$	1.8	3.5		mW
Peak emission wavelength	$\lambda_p$	$I_F = 50 \text{ mA}$		950		nm
Spectral half band width	$\Delta\lambda$	$I_F = 50 \text{ mA}$		50		nm
Forward voltage (DC)	$V_F$	$I_F = 50 \text{ mA}$			1.5	V
Reverse current (DC)	$I_R$	$V_R = 3 \text{ V}$			10	$\mu\text{A}$
Capacitance between pins	$C_t$	$V_R = 0 \text{ V}$ , $f = 1 \text{ MHz}$		35		pF
Half-power angle	$\theta$	The angle in which radiant intensity is 50%		35		deg.

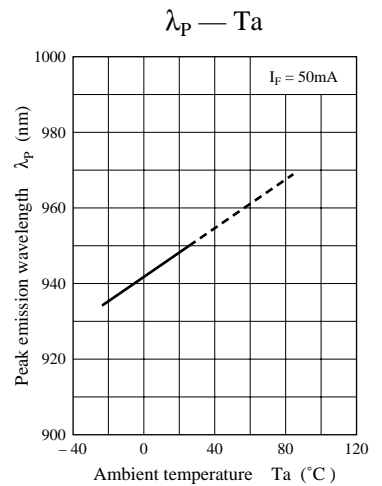
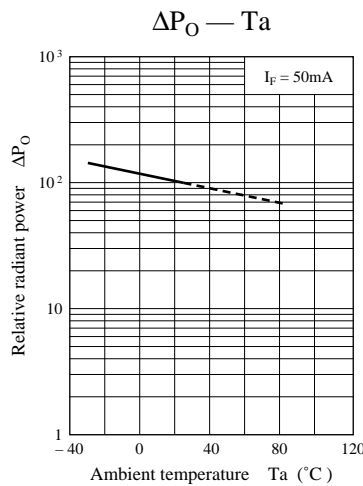
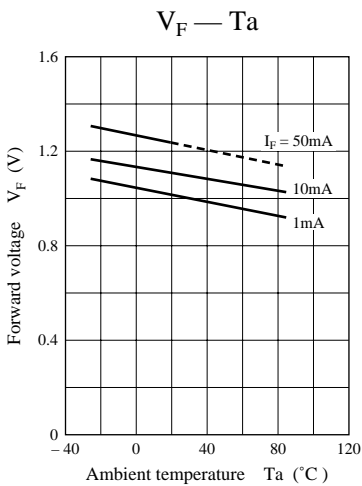
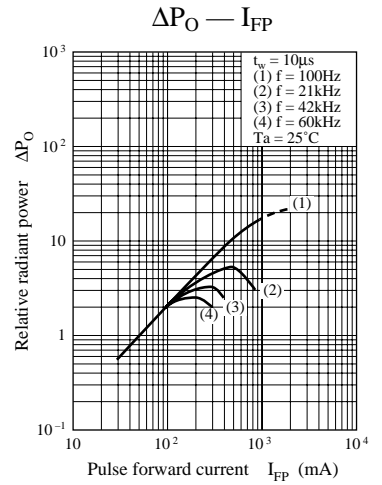
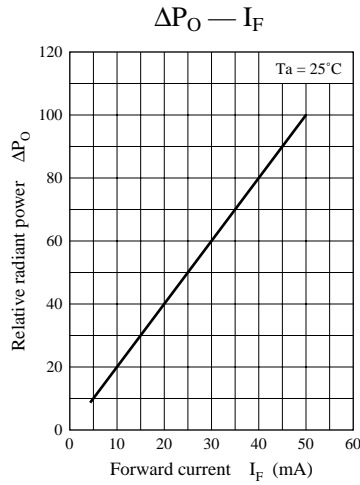
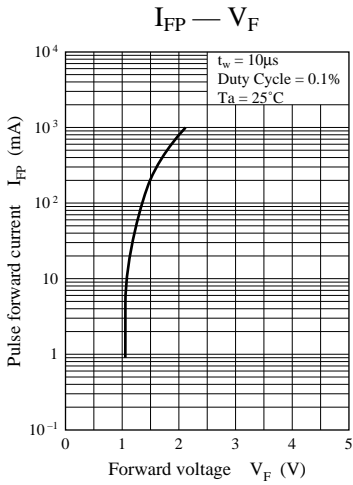
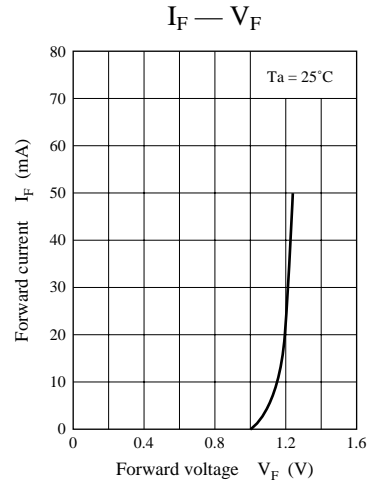
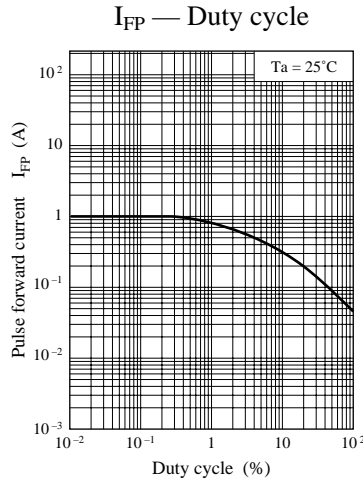
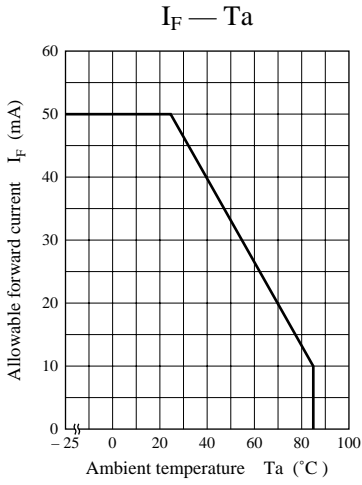

Spectral characteristics

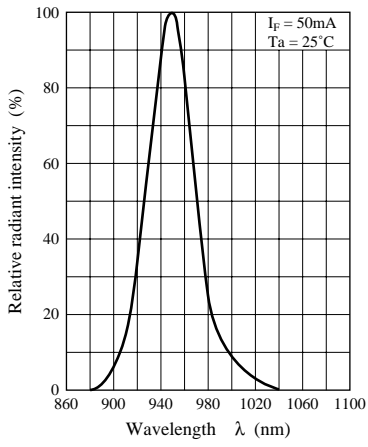

Directivity characteristics

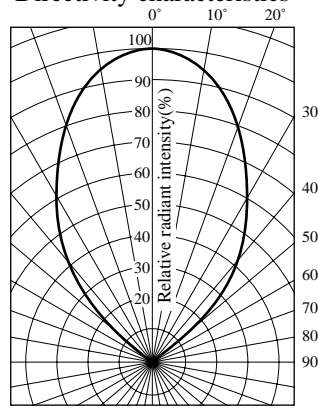

Frequency characteristics

