

LN66(NC)

GaAs Infrared Light Emitting Diode

For optical control systems

■ Features

- High-power output, high-efficiency : $P_O = 8 \text{ mW}$ (typ.)
- Emitted light spectrum suited for silicon photodetectors
- Good radiant power output linearity with respect to input current
- Wide directivity : $\theta = 25 \text{ deg.}$ (typ.)
- Dark blue resin package

■ Absolute Maximum Ratings ($T_a = 25^\circ\text{C}$)

| Parameter | Symbol | Ratings | Unit |
|-------------------------------|------------|-------------|------------------|
| Power dissipation | P_D | 160 | mW |
| Forward current (DC) | I_F | 100 | mA |
| Pulse forward current | I_{FP}^* | 1.5 | A |
| Reverse voltage (DC) | V_R | 3 | V |
| Operating ambient temperature | T_{opr} | -25 to +85 | $^\circ\text{C}$ |
| Storage temperature | T_{stg} | -40 to +100 | $^\circ\text{C}$ |

* $f = 100 \text{ Hz}$, Duty cycle = 0.1 %

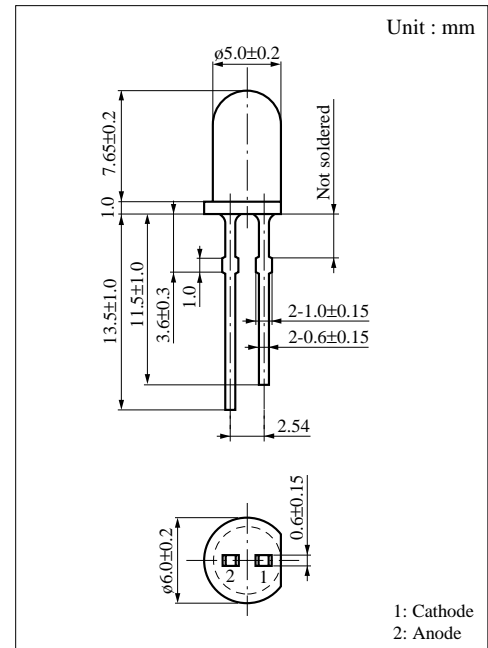

■ Electro-Optical Characteristics ($T_a = 25^\circ\text{C}$)

| Parameter | Symbol | Conditions | min | typ | max | Unit |
|--------------------------|-----------------|---|-----|-----|-----|---------------|
| Radiant power | P_O^* | $I_F = 50\text{mA}$ | 5 | 8 | | mW |
| Peak emission wavelength | λ_P | $I_F = 50\text{mA}$ | | 950 | | nm |
| Spectral half band width | $\Delta\lambda$ | $I_F = 50\text{mA}$ | | 50 | | nm |
| Forward voltage (DC) | V_F | $I_F = 100\text{mA}$ | | 1.3 | 1.6 | V |
| Reverse current (DC) | I_R | $V_R = 3\text{V}$ | | | 10 | μA |
| Capacitance between pins | C_t | $V_R = 0\text{V}$, $f = 1\text{MHz}$ | | 35 | | pF |
| Half-power angle | θ | The angle in which radiant intensity is 50% | | 25 | | deg. |

* P_O Classifications

| Class | R | S |
|------------|--------|----|
| P_O (mW) | 5 to 8 | >7 |

$I_F - T_a$

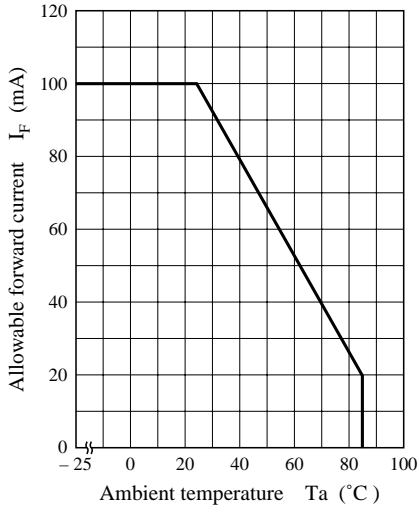

$I_{FP} - \text{Duty cycle}$

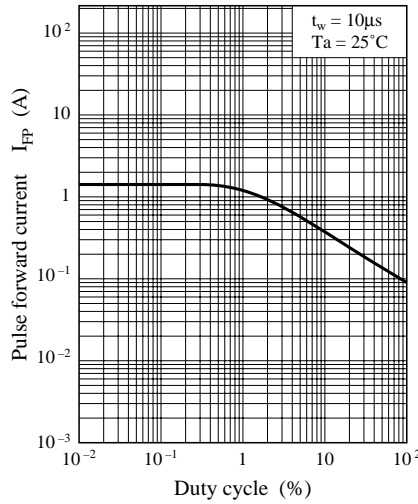

$I_F - V_F$

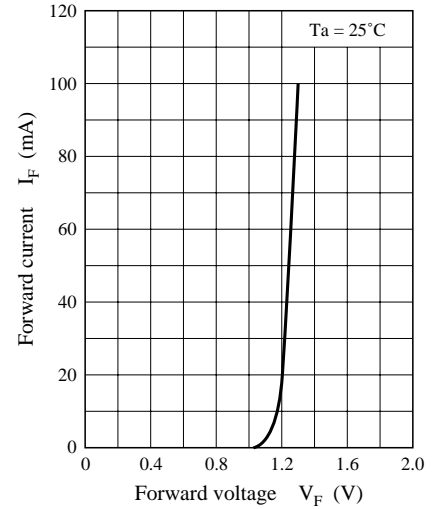

$\Delta P_O - I_{FP}$

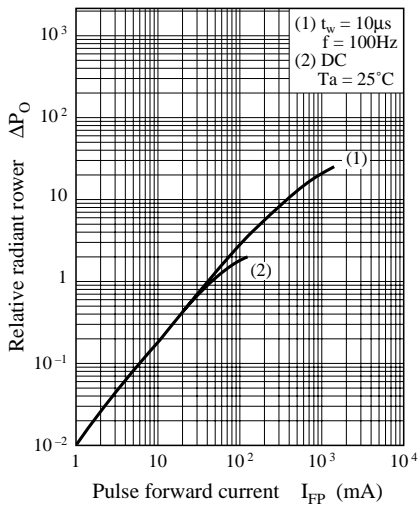

$V_F - T_a$

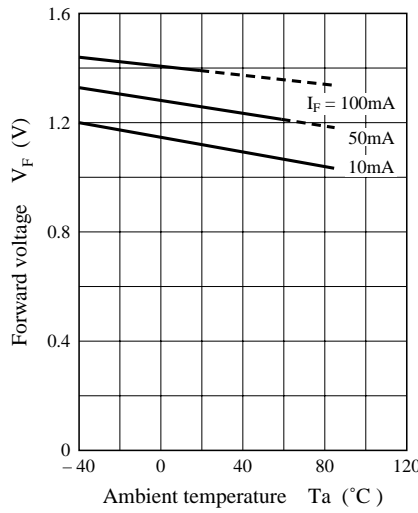

$\Delta P_O - T_a$

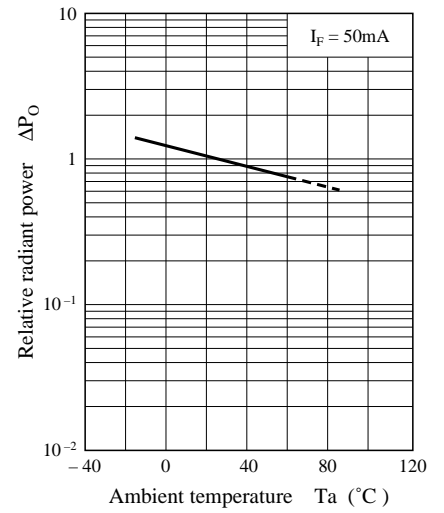

$\lambda_p - T_a$

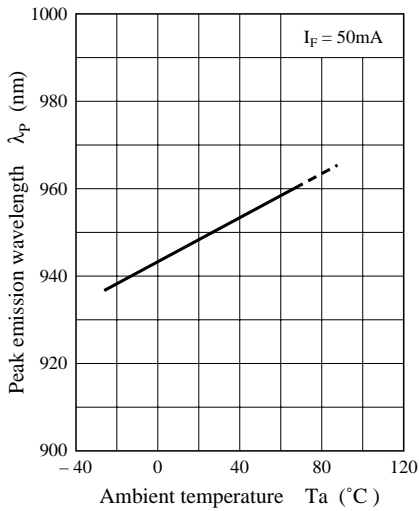

Spectral characteristics

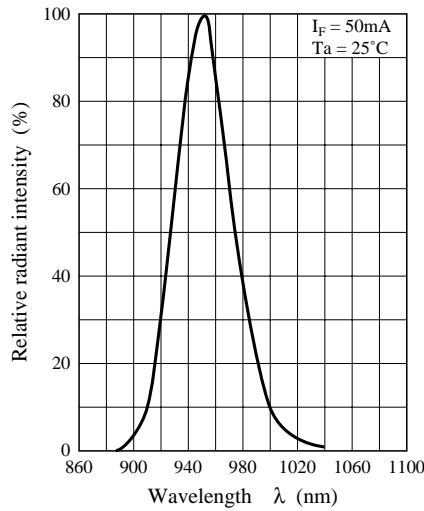

Directivity characteristics

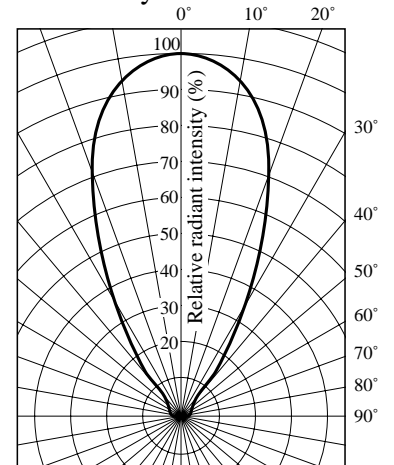

Frequency characteristics

