

HUL7001

Hologram Unit

For optical information processing

■ Features

- Smaller package size achieved through micro-mirror integration
(4.8 × 8.2 × 4.3 mm)
- Focus error signal detection : SSD method
- Tracking error signal detection : 3-beam method
- Low-power semiconductor laser included

■ Applications

- CD

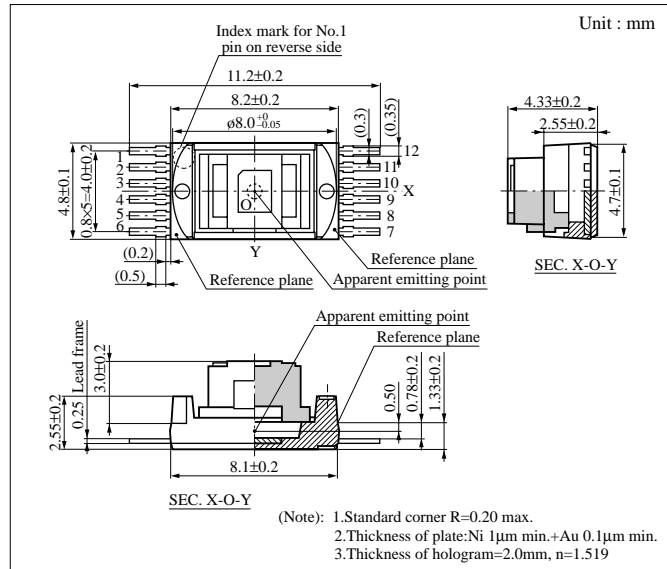

■ Absolute Maximum Ratings (Ta = 25°C)

Parameter	Symbol	Rated	Unit
Laser beam output	P _O	0.3	mW
Laser reverse voltage	V _{R(LD)}	2	V
Monitor PD reverse voltage	V _{R(mon)}	12	V
Signal processing PD reverse voltage	V _R	12	V
Operating ambient temperature	T _{opr}	-10 to +60	°C
Storage temperature	T _{stg}	-40 to +85	°C

■ Unit Characteristic Specifications (Tc = 25 ± 3°C)

Parameter	Symbol	Conditions	min	typ	max	Unit
Threshold current	I _{th} ^{*1}	CW	20	30	40	mA
Operating current	I _{OP} ^{*1,2}	CW I _{RF} = 10μA, V _R = 5V	25	35	45	mA
Operating voltage	V _{OP} ^{*1,2}	CW I _{RF} = 10μA, V _R = 5V		1.9	2.4	V
Laser beam output	P _O ^{*1,2}	I _{RF} = 10μA, V _R = 5V		0.15	0.22	mW
Focus error signal amplitude	I _{FE} ^{*1,3}	I _{RF} = 10μA, V _R = 5V	7	10	13	μA
Tracking error signal amplitude	I _{TE} ^{*1,4}	I _{RF} = 10μA, V _R = 5V	0.8	1.3	1.8	μA
Focus error signal defocusing	D _{FO} ^{*1,5}	I _{RF} = 10μA, V _R = 5V	-8		+8	%
Tracking error signal symmetry	B _{TE} ^{*1,4}	I _{RF} = 10μA, V _R = 5V	-30		+30	%
Focus error signal pull-in range	D _{FE} ^{*1,3}	I _{RF} = 10μA, V _R = 5V		12		μm

^{*1} Measurements are made using the reference optical system during measurement and the radiant power measurement system on the hologram unit shown in Fig. 2.

^{*2} It should be noted that the RF signal amplitude in these specifications is denoted by I_{RF}, and represents the amplitude of the 11T signal. As in the case described in ^{*1}, I_{RF} is measured using the measurement system shown in Fig. 2.

^{*3} The definition is illustrated in Fig. 3.

^{*4} The definition is illustrated in Fig. 4.

^{*5} The definition is illustrated in Fig. 5.

Characteristic Specifications for Semiconductor Laser, Monitor PD, and Signaling Processing PD ($T_c = 25 \pm 3^\circ C$)

Parameter	Symbol	Conditions	min	typ	max	Unit
Semiconductor laser						
Oscillating wavelength	λ_L *6	CW $I_{RF} = 10\mu A, V_R = 5V$	775	790	805	nm
Coherence	λ *6	CW $I_{RF} = 10\mu A, V_R = 5V$		0.5	0.9	
Monitor PD and signal processing PD						
Monitor current	$I_{P(mon)}$ *7	CW $I_{RF} = 10\mu A, V_R = 5V$	0.3	0.7	1.2	mA
Dark current	I_D	$V_R = 2.5V$		0.2	3.0	nA
	$I_{D(mon)}$ *8	$V_R = 5V$		0.3	30	nA
Capacitance between pins	$C_{t(RF1)}$ *9	$V_R = 2.5V, f = 1MHz$		2		pF
	$C_{t(RF2)}$ *9			3		pF
Shield frequency	f_C	$V_R = 2.5V, R_L = 50\Omega$		40		MHz

*6 Measurements are made using the radiant power measurement system on the hologram unit. The definition is presented in Fig. 2.

*7 Unless otherwise indicated, the values shown are per individual element.

*8 The subscript (mon) denotes the element (monitor PD).

*9 $C_{t(RF1)}$ denotes the capacitance measured at pin No. 4 or 10 in the electrode connection diagram. $C_{t(RF2)}$ denotes the capacitance measured at pin No. 5 or 9 in the electrode connection diagram.

Connection Diagram (Fig. 1)

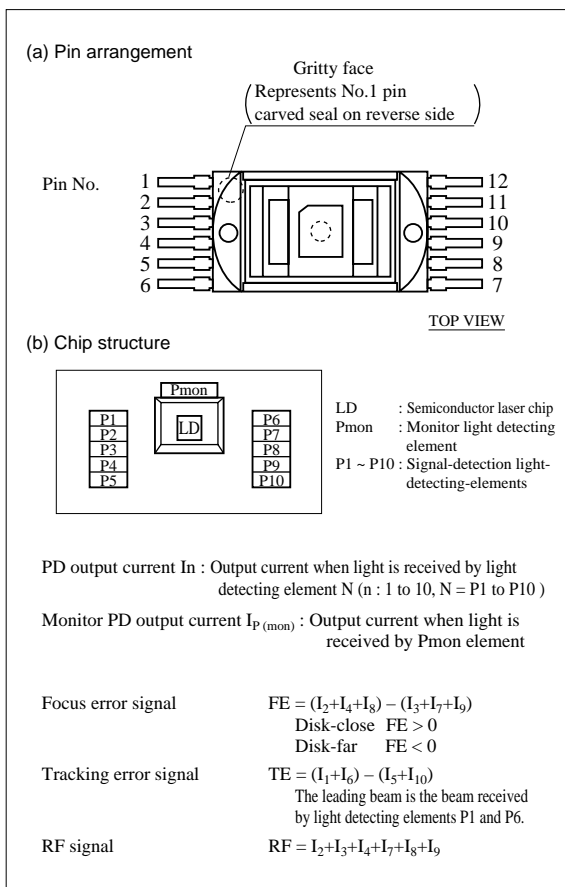

Pin Description

Pin No.	Function	Calculation
1	Source voltage Applications pin	
2	Monitor current output pin	$I_{P(mon)}$
3	Tracking error signal output pin	$I_1 + I_6$
4	RF and focus error signal output pin	I_3
5	RF and focus error signal output pin	$I_2 + I_4$
6	Source voltage Applications pin	
7	Source voltage Applications pin	
8	Tracking error signal output pin	$I_5 + I_{10}$
9	RF and focus error signal output pin	$I_7 + I_9$
10	RF and focus error signal output pin	I_8
11	LD + Power supply pin	
12	GND pin	

Electrode Connection Diagram

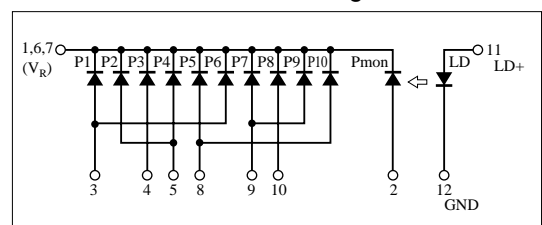

■ Optical Block Diagram During Measurement (Fig. 2)

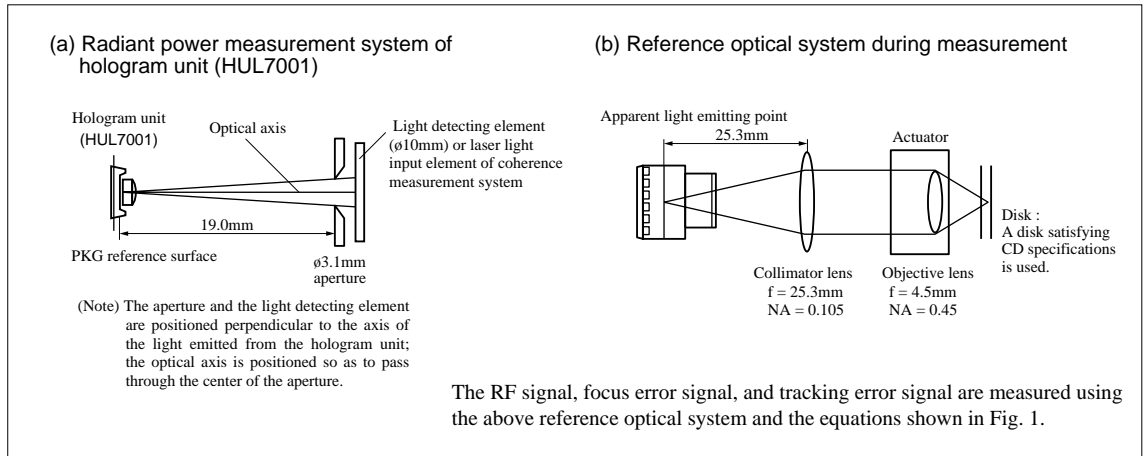

■ Focus Error Signal Amplitude and Pull-in Range (Fig. 3)

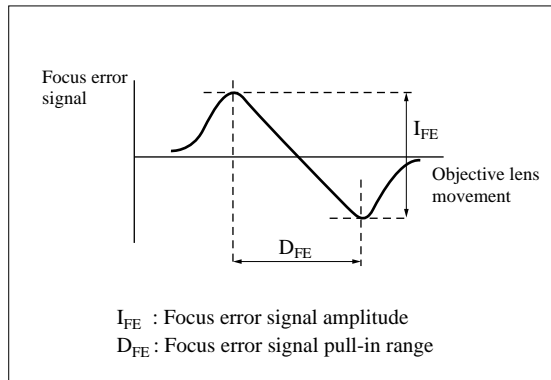

■ Tracking Error Signal Amplitude and Pull-in Range (Fig. 4)

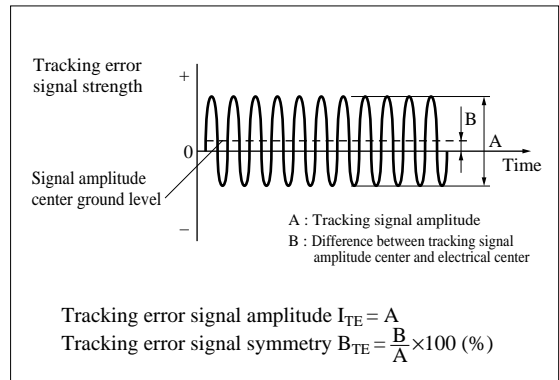

■ Focus Error Signal Defocusing (Fig. 5)

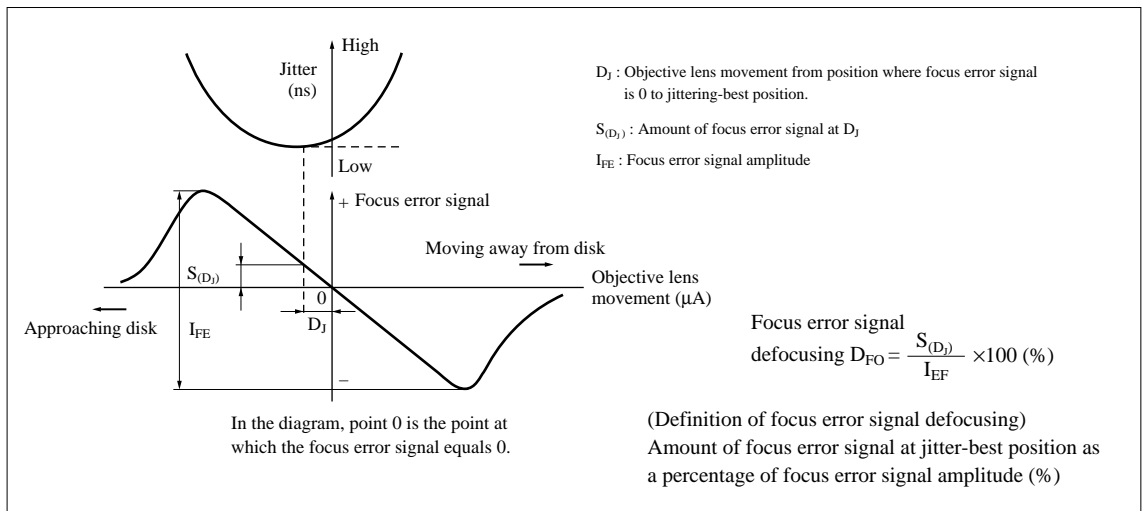

■ Important LDHU Usage Information

Panasonic's laser detector hologram unit (LDHU) has features of using a plastic package, and of integrating a low-current-operating, high-efficiency laser and a photodetector in order to reduce the size and weight of the optical pickup.

Please follow the instructions presented below to take advantage of this feature and ensure that the pickup is highly reliable.

1. Static Electricity

The semiconductor laser used in the LDHU is characteristically, especially sensitive to static electricity, in semiconductor devices. Therefore care must be taken in handling the semiconductor laser. If the laser receives a pulse which causes light to be emitted in excess of the maximum rating of the laser, the laser itself could be damaged by the optical energy.

Therefore it is very important to take measures to protect the LDHU from static electricity and surges when putting together assembly lines or when handling it during manufacturing processes.

- (1) Check all drive circuitry, including the power supply. Take sufficient preventive measures to ensure that, for example, spike currents generated when the power switch is turned on or off never exceed the absolute maximum ratings of the LDHU. Also insert appropriate protective circuits in the LDHU drive circuitry.
- (2) Be careful not to allow static electricity to destroy the LDHU while handling it. Effective measures for protecting against static electricity include body grounds (passing through $1M\Omega$), as well as conductive mats for the floor, conductive clothing, conductive shoes, and conductive containers. The tips of soldering irons must be grounded. We recommend using ionizers, etc., especially around facilities and areas where static electricity is easily generated.
- (3) The laser may also be destroyed by abnormal pulses from nearby equipment. Therefore fluorescent lights and measuring equipments should not be turned on or off near the laser.

2. LDHU Heat-Release Design

The semiconductor laser, which is the light emitting device, naturally has a limited service life. This service life is shortened as the temperature is increased. Therefore the design should include suitable heat-releasing measures. Heat release from the lead frame and the back of the package must be incorporated into the design in order to improve heat-releasing capabilities. For assistance in evaluating heat-releasing capabilities (thermal resistance), please contact us.

3. Storing LDHU Units After Removal from Aluminum-Laminated Bags

If supplies are stored prior to mounting for extended periods of time in a high-humidity environment, subsequent heating during solder mounting will cause moisture in the parts to vaporize. This may cause problems related to part characteristics.

In order to prevent moisture absorption, LDHU units are packaged in moistureproof aluminum-laminated bags which are sealed together with silica gel before shipping. After LDHU units are removed from these moistureproof bags, the mounting process should be completed quickly. Unused LDHU units which have been unsealed and require extended storage should be put back in their aluminum-laminated bags (along with the silicagel) and resealed.

The recommended environment for LDHU mounting is a temperature range of 5°C to 35°C and a relative humidity range of 45% to 75%. (To prevent excessive humidity and because static electricity occurs more easily if the humidity is too low.)

4. Important Information Regarding Soldering

- Special plastics are used in the LDHU package and hologram. Therefore only the leads (pins) should be heated (during soldering iron, dip, etc.), and soldering time should be short. Total heating methods such as reflow soldering should be avoided. (This device is gold-plated to ensure good solder adhesion, so a short soldering time is sufficient.) It is also recommended that a heat sink or other means be used to improve the package's heat-releasing effects in order to prevent the package from becoming hot as a result of heat transfer and radiation even when the leads are heated.

- Soldering location

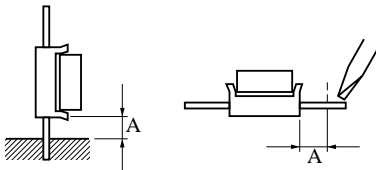

A : Make sure there is a gap of at least 1mm.

- Soldering temperature and time
Temperature : 260°C maximum
Time : 5 seconds maximum

5. Flux cleaning method

- Alcohol is recommended as a solvent for flux cleaning. Chlorine base solvents in particular are a cause of lead corrosion and device deterioration. Petroleum base solvents should be avoided since they deteriorate the adhesive between the hologram and package.
- In addition, ultrasonic cleaning should be avoided since the device is hollow. Care should be taken in brushing the hologram surface, as this may scratch the back side.

6. Mechanical stress

- (1) Pressure on the package

The LDHU package is made thin in order to reduce its size. Therefore, pressure on the package resulting of heat release, etc. may cause problems such as a change in the package shape or changes to its characteristics. In the point pressure application, force should be limited to 1kgf (9.8N) or less, but please design so that the area pressure application can be adopted as much as possible.

- (2) Lead formation and cutting

In cases where lead formation and cutting are required, these actions must be performed at normal temperatures prior to soldering. Machining steps performed at high temperatures immediately after soldering, or after the solder has hardened should be avoided. In addition, steps should be taken to ensure that excessive mechanical stress is not applied during lead formation and cutting. Special care should be taken to avoid stress on the lead bases of the package, as this may create problems such as chipping the resin.

7. Other issues

- (1) The surface of the hologram is very important for light emission and light detecting. Therefore care should be taken to ensure that there are no fingerprints on the surface, residual flux after soldering, or adhering dust.
- (2) Viewing the laser beam with the naked eye is extremely dangerous and may result in blindness. Do not look directly at the laser while it is operating.
- (3) The products listed in this document are intended for use in standard applications, i.e., general electronic devices (such as office equipment, measuring equipment, and consumer electronics products). Customers considering applications involving special quality and reliability requirements and carrying a risk of loss of human life or bodily damage in the event of an accident or malfunction, or specific applications (such as aerospace applications, transportation equipment, combustion equipment, and safety devices), and customers considering applications other than the standard applications intended by us should contact our sales office before using these products.