

LNC802PS

GaAlAs Semiconductor Laser

Features

- Low threshold current
- Stable single horizontal mode oscillation
- Long lifetime, high reliability
- High radiant power : 50mW

Applications

- Optical data processing devices
- Optical disk memory
- Medical equipment

Absolute Maximum Ratings (Ta = 25°C)

Parameter	Symbol	Rated	Unit	
Radiant power	P_O	50	mW	
Reverse voltage	Laser	V_R	1.5	V
	PIN	V_R (PIN)	30	V
Power dissipation	P_d (PIN)	100	mW	
Operating ambient temperature	T_{opr}	-10 to +60	°C	
Storage temperature	T_{stg}	-40 to +80	°C	

Electro-Optical Characteristics (Ta = 25°C)

Parameter	Symbol	Conditions	min	typ	max	Unit
Threshold current	I_{th}	CW	10	30	50	mA
Operating current	I_{OP}	CW $P_O = 40mW$	45	65	100	mA
Operating voltage	V_{OP}	CW $P_O = 40mW$		2.0	3.0	V
Oscillation wavelength	λ_L	CW $P_O = 40mW$	815	830	845	nm
Radiation angle	Horizontal direction	$\theta_{//}^{*1}$	7	10	13	deg.
	Vertical direction	θ_{\perp}^{*1}	18	25	30	deg.
Differential efficiency	η	CW $P_O = 36mW/I(40mW - 4mW)$	0.6	1.0	1.5	
PIN photo current	I_P	CW $P_O = 40mW, V_R$ (PIN) = 5V				mA
Reverse current (DC)	I_R	V_R (PIN) = 15V			0.1	μA
Optical axis accuracy	X direction	θ_X	-2.0		+2.0	deg.
	Y direction	θ_Y	-3.0		+3.0	deg.

*1 The radiation angle is indicated as half full angles.

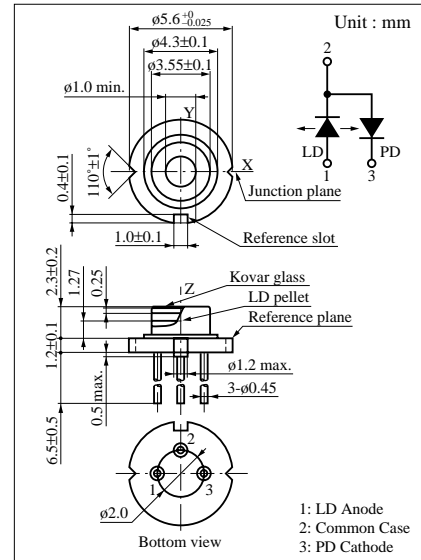

$P_O - I_{OP}$

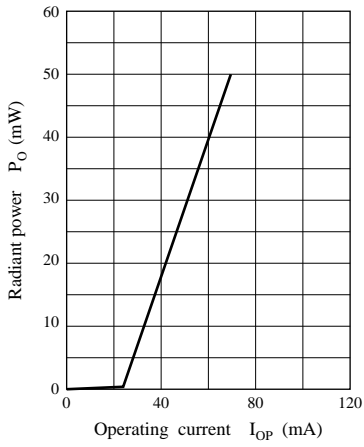

$I - V$

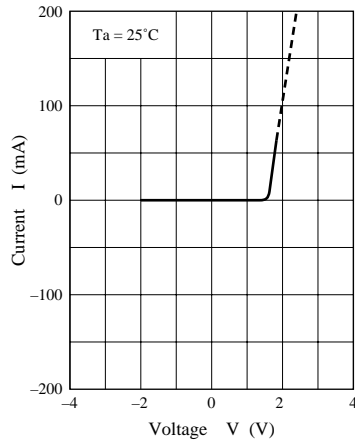

Far field pattern

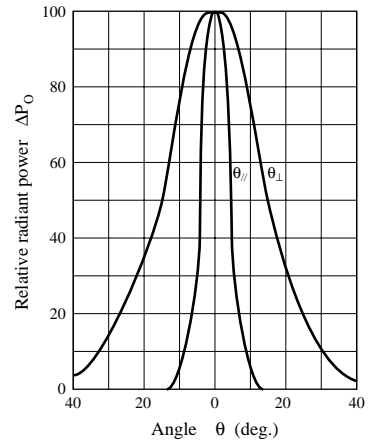

$I_{th} - T_a$

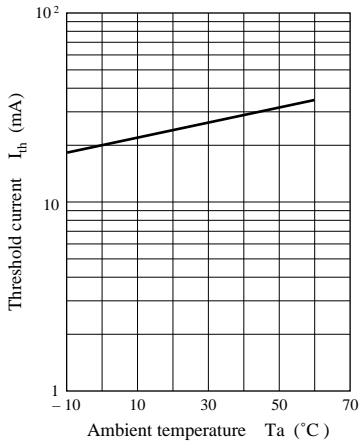

$I_{OP} - T_a$

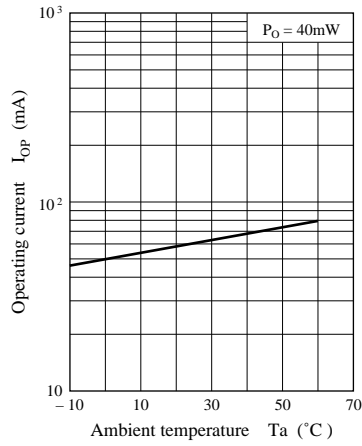

$P_O - T_a$

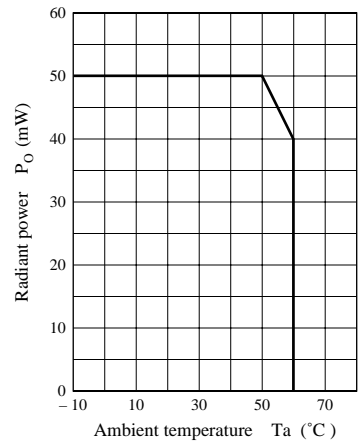

$I_d - T_a$

