

LNC801PS

High Power Output Semiconductor Laser

Overview

The LNC801PS is a GaAlAs laser diode which provides stable, continuous, single mode oscillation of near infrared light at room temperature. This product can be used in a wide range of light source applications, including laser printers, facsimiles, optical disk memory, and optical information devices.

Features

- Low threshold oscillation
- Stable single horizontal mode oscillation
- Built-in PIN photodiode for light output monitors
- Light output is continuously variable as far as 60 mW
- Supports direct modulation
- Near infrared oscillating wavelength
- Long lifetime, high reliability

Absolute Maximum Ratings (Ta = 25°C)

Parameter	Symbol	Ratings	Unit	
Radiant power	P _O	60	mW	
Reverse voltage	Laser	V _R	1.5	V
	PIN	V _R (PIN)	30	V
Power dissipation	P _d (PIN)	100	mW	
Operating ambient temperature	T _{opr}	-10 to +60	°C	
Storage temperature	T _{stg}	-40 to +80	°C	

Electro-Optical Characteristics (Ta = 25°C)

Parameter	Symbol	Conditions	min	typ	max	Unit	
Threshold current	I _{th}	CW	10	30	50	mA	
Operating current	I _{OP}	P _O = 50mW	50	70	120	mA	
Operating voltage	V _{OP}	P _O = 50mW		2.0	3.0	V	
Oscillation wavelength	λ _L	P _O = 50mW	815	830	845	nm	
Radiation angle	Horizontal direction	θ _{//} *	P _O = 50mW	7	10	13	deg.
	Vertical direction	θ _⊥ *	P _O = 50mW	18	25	28	deg.
Differential efficiency	η	CW P _O = 36mW/I(40mW - 4mW)	0.6	1.0	1.5	mW/mA	
Reverse current (DC)	I _R	V _R (PIN) = 5V			0.1	μA	
PIN photo current	I _P	P _O = 50mW, V _R (PIN) = 5V				mA	
Optical axis accuracy	X direction	θ _X	P _O = 50mW	-2.0		+2.0	deg.
	Y direction	θ _Y	P _O = 50mW	-3.0		+3.0	deg.
Oscillation mode		Single horizontal mode					

* θ_{//} and θ_⊥ are the angles where the optical intensity is a half of its max. value. (half full angle)

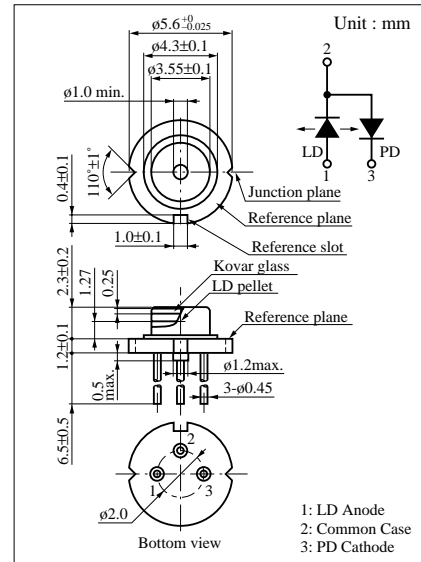

$P_O - I_{OP}$

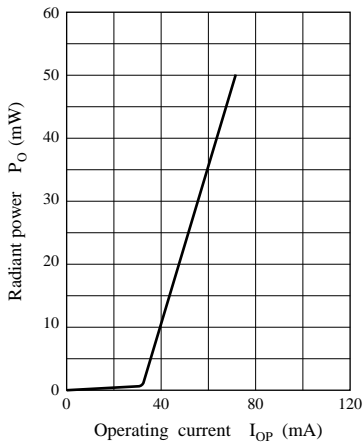

$I - V$

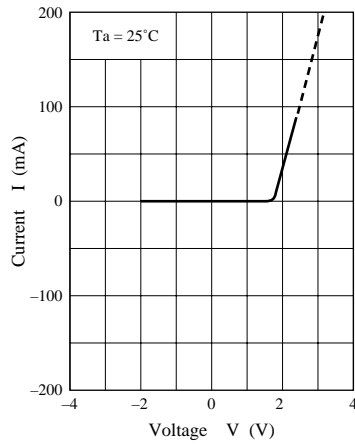

Far field pattern

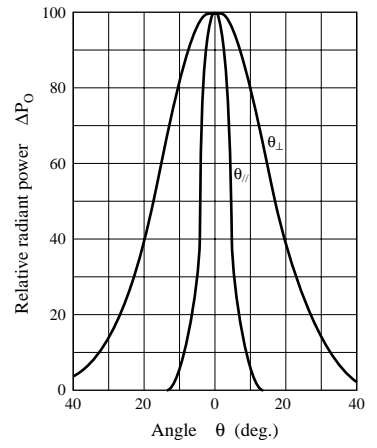

$I_{th} - T_a$

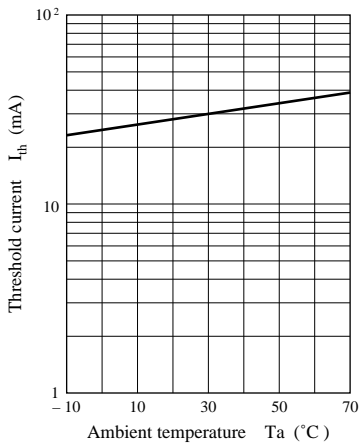

$I_{OP} - T_a$

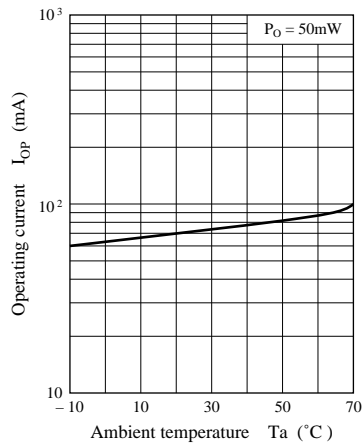

$P_O - T_a$

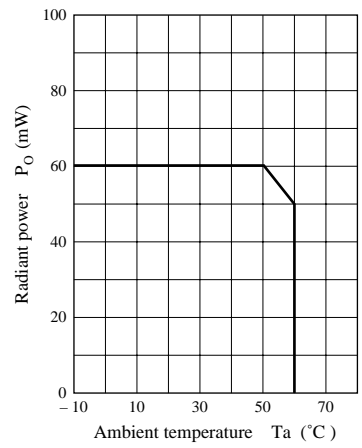

$I_d - T_a$

