

PNZ109L

Silicon NPN Phototransistor

For optical control systems

■ Features

- High sensitivity : $I_{CE(L)} = 3.5 \text{ mA (min.) (at } L = 100 \text{ lx)}$
- Built-in filter to cutoff visible light for reducing ambient light noise
- Peak sensitivity wavelength matched with infrared light emitting devices : $\lambda_p = 900 \text{ nm (typ.)}$
- Fast response : $t_r = 5 \text{ } \mu\text{s (typ.)}$
- Long lifetime, high reliability

■ Absolute Maximum Ratings (Ta = 25°C)

Parameter	Symbol	Ratings	Unit
Collector to emitter voltage	V_{CEO}	20	V
Collector to base voltage	V_{CBO}	30	V
Emitter to collector voltage	V_{ECO}	3	V
Emitter to base voltage	V_{EBO}	5	V
Collector current	I_C	30	mA
Collector power dissipation	P_C	150	mW
Operating ambient temperature	T_{opr}	-25 to +85	°C
Storage temperature	T_{stg}	-30 to +100	°C

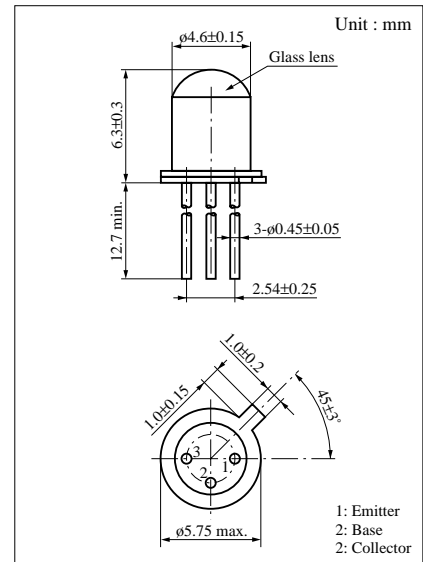

■ Electro-Optical Characteristics (Ta = 25°C)

Parameter	Symbol	Conditions	min	typ	max	Unit
Dark current	I_{CEO}	$V_{CE} = 10V$		0.05	2	μA
Collector photo current	$I_{CE(L)}$	$V_{CE} = 10V, L = 100 \text{ lx}^{*1}$	3.5			mA
Peak sensitivity wavelength	λ_p	$V_{CE} = 10V$		900		nm
Acceptance half angle	θ	Measured from the optical axis to the half power point		10		deg.
Rise time	t_r^{*2}	$V_{CC} = 10V, I_{CE(L)} = 5\text{mA}$		5		μs
Fall time	t_f^{*2}	$R_L = 100\Omega$		6		μs
Collector saturation voltage	$V_{CE(sat)}$	$I_{CE(L)} = 1\text{mA}, L = 500 \text{ lx}^{*1}$		0.3	0.6	V

*1 Measurements were made using a tungsten lamp (color temperature $T = 2856\text{K}$) as a light source.

*2 Switching time measurement circuit

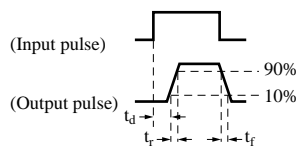
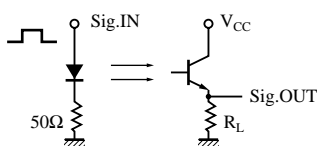

t_d : Delay time

t_r : Rise time (Time required for the collector photo current to increase from 10% to 90% of its final value)

t_f : Fall time (Time required for the collector photo current to decrease from 90% to 10% of its initial value)

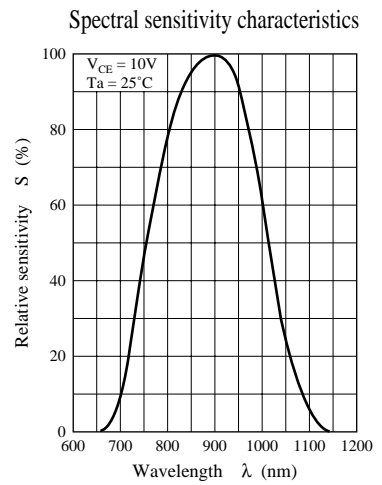
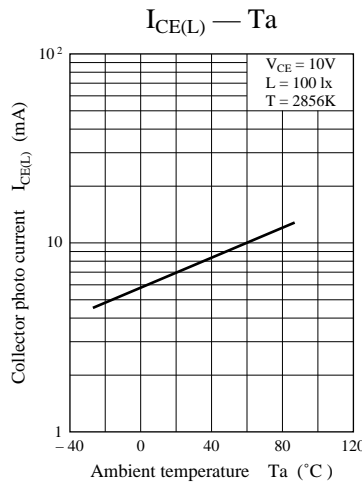
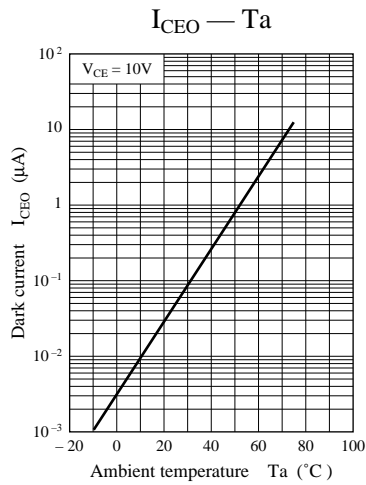
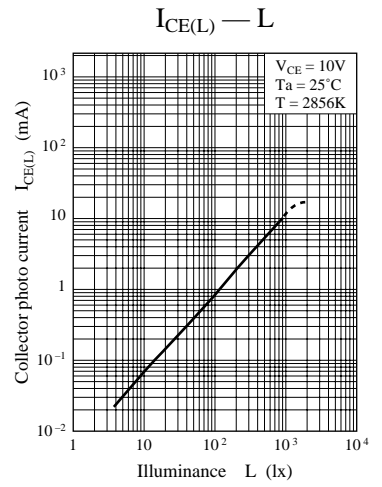
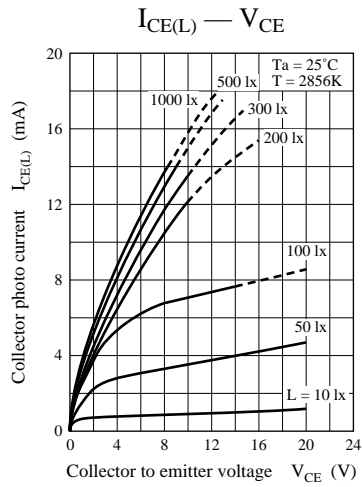
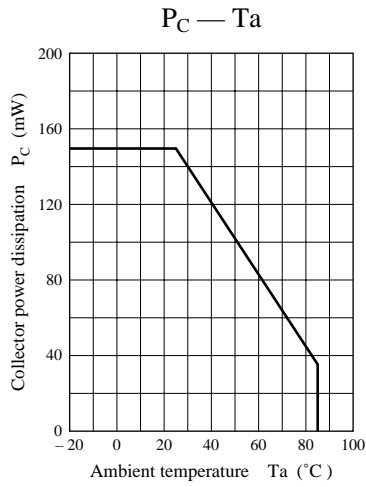

Directivity characteristics

