

PNZ330CL

PIN Photodiode

For optical fiber communication systems

■ Features

- TO-18 standard type package
- High coupling capability suitable for plastic fiber
- High quantum efficiency
- High-speed response

■ Absolute Maximum Ratings (Ta = 25°C)

Parameter	Symbol	Ratings	Unit
Reverse voltage (DC)	V_R	30	V
Power dissipation	P_D	100	mW
Operating ambient temperature	T_{opr}	-25 to +85	°C
Storage temperature	T_{stg}	-30 to +100	°C

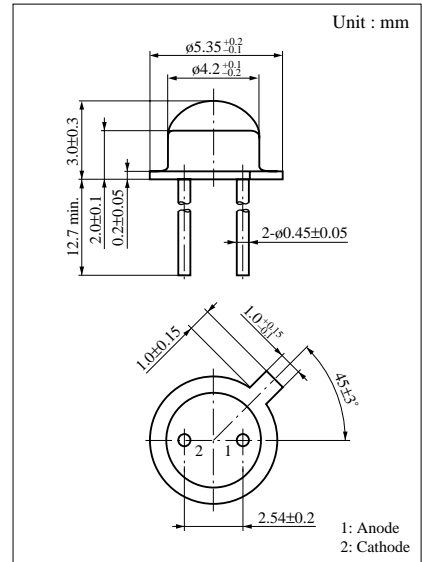

■ Dimensions of detection area

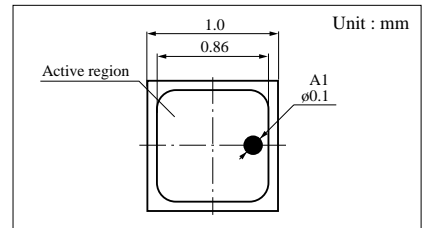

■ Electro-Optical Characteristics (Ta = 25°C)

Parameter	Symbol	Conditions	min	typ	max	Unit
Dark current	I_D	$V_R = 10V$		0.1	10	nA
Photo current	I_L	$V_R = 10V, L = 1000 \text{ lx}^{*1}$	7	10		μA
Peak sensitivity wavelength	λ_p	$V_R = 10V$		850		nm
Response time	t_r, t_f^{*2}	$V_R = 10V, R_L = 50\Omega$		2		ns
Capacitance between pins	C_t	$V_R = 10V, f = 1\text{MHz}$		7		pF
Acceptance half angle	θ	Measured from the optical axis to the half power point		70		deg.

*1 Measurements were made using a tungsten lamp (color temperature T = 2856K) as a light source.

*2 Switching time measurement circuit

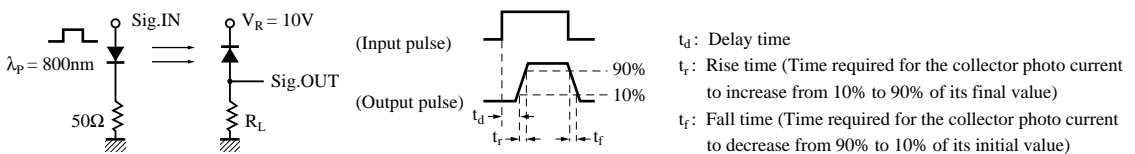

Note) Difficult to guarantee compliance with moisture resistance standard (MIL-STD-202D)

$I_L - L$

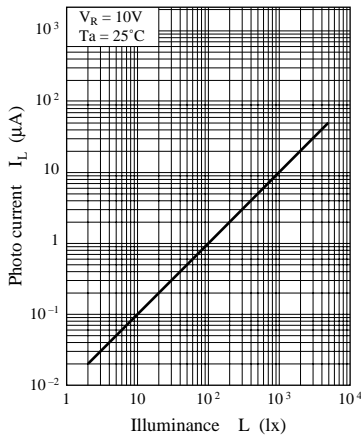

$I_L - V_R$

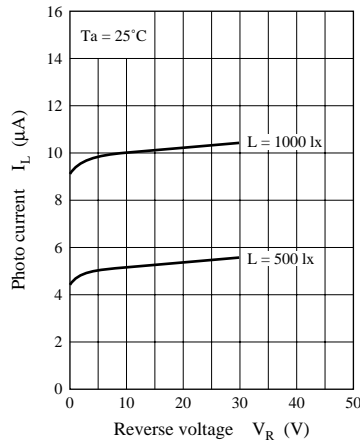

$I_L - T_a$

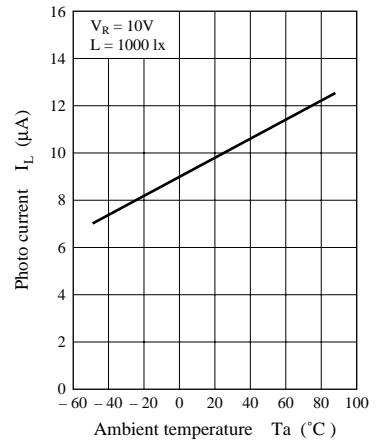

$I_D - T_a$

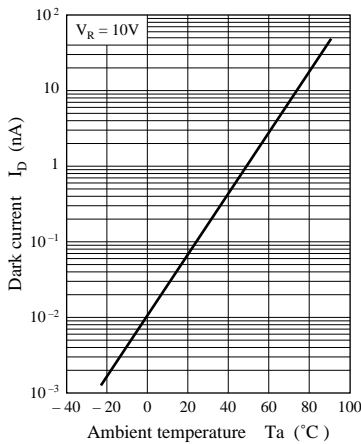

$t_r, t_f - R_L$

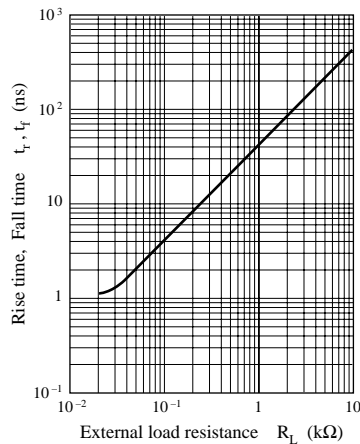

Spectral sensitivity characteristics

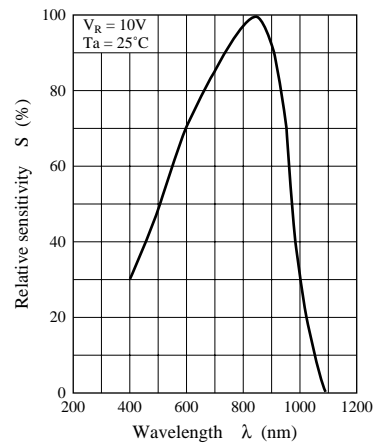

Directivity characteristics

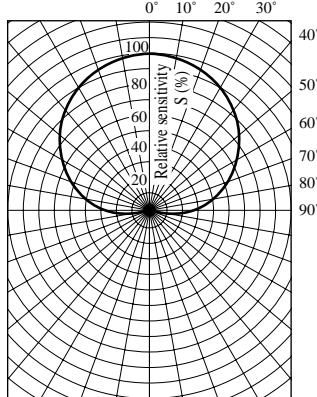

Coupling loss characteristics

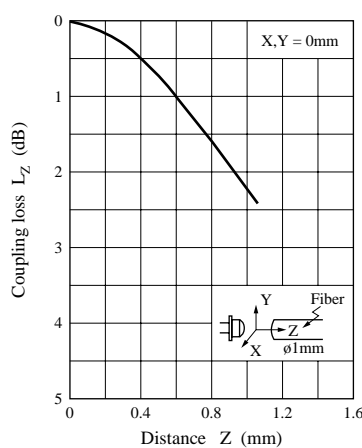

Coupling loss characteristics

