

PNZ331CL

PIN Photodiode

For optical fiber communication systems

■ Features

- TO-18 standard type package
- High coupling capability suitable for plastic fiber
- High quantum efficiency
- High-speed response

■ Absolute Maximum Ratings (Ta = 25°C)

Parameter	Symbol	Ratings	Unit
Reverse voltage (DC)	V_R	30	V
Power dissipation	P_D	50	mW
Operating ambient temperature	T_{opr}	-25 to +85	°C
Storage temperature	T_{stg}	-30 to +100	°C

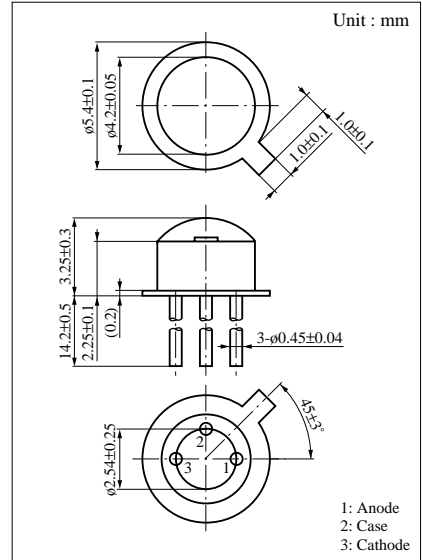

■ Dimensions of detection area

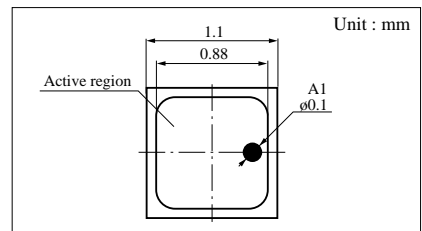

■ Electro-Optical Characteristics (Ta = 25°C)

Parameter	Symbol	Conditions	min	typ	max	Unit
Dark current	I_D	$V_R = 10V$		0.1	10	nA
Photo current	I_L	$V_R = 10V, L = 1000 \text{ lx}^*1$	7	14		μA
Peak sensitivity wavelength	λ_p	$V_R = 10V$		900		nm
Response time	t_r, t_f^{*2}	$V_R = 10V, R_L = 50\Omega$		2		ns
Capacitance between pins	C_i	$V_R = 10V$		3		pF
Photodetection sensitivity	R	$V_R = 10V, \lambda = 800\text{nm}$		0.55		A/W
Acceptance half angle	θ	Measured from the optical axis to the half power point		70		deg.
Photodetection surface shape	D	Effective detection area		$\square 0.88$		mm

Note 1) Spectral sensitivity: Sensitivity at wavelengths exceeding 400 nm as a percentage of maximum sensitivity is 100%

Note 2) This product is not designed to withstand electromagnetic radiation or heavy-charge particles.

Note 3) Difficult to guarantee compliance with moisture resistance standard (MIL-STD-202D)

*1 Measurements were made using a tungsten lamp (color temperature T = 2856K) as a light source.

*2 Switching time measurement circuit (see figure below)

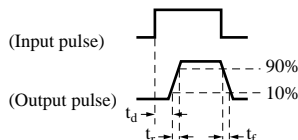
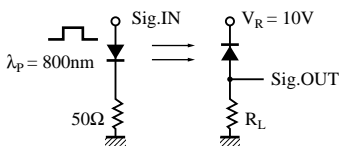

t_d : Delay time

t_r : Rise time (Time required for the collector photo current to increase from 10% to 90% of its final value)

t_f : Fall time (Time required for the collector photo current to decrease from 90% to 10% of its initial value)

$P_D - T_a$

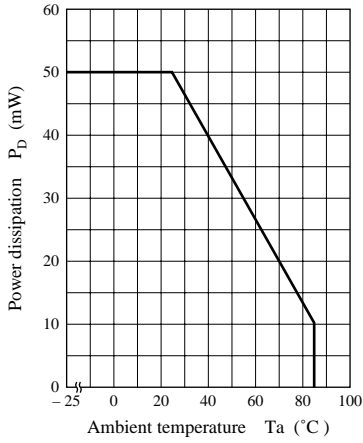

$I_L - L$

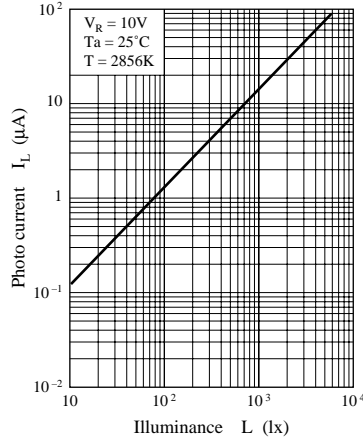

$I_L - P$

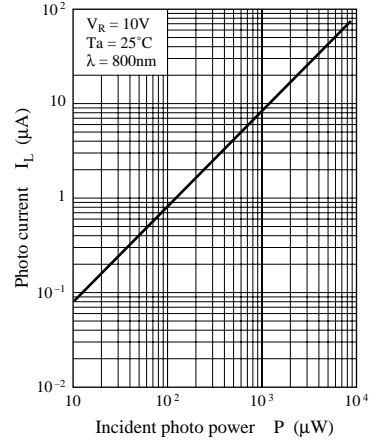

$I_D - V_R$

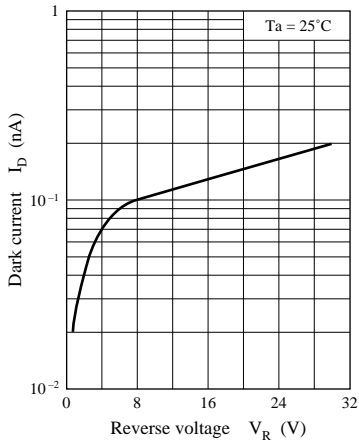

$I_D - T_a$

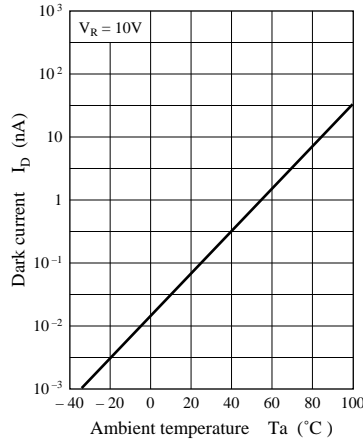

$R - T_a$

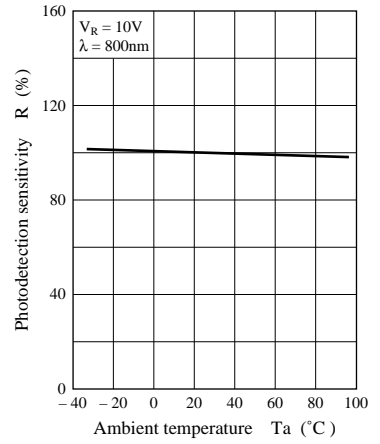

$I_L - T_a$

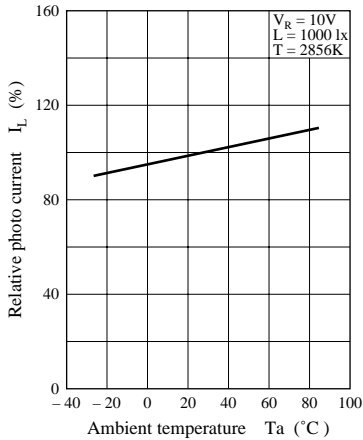

Spectral sensitivity characteristics

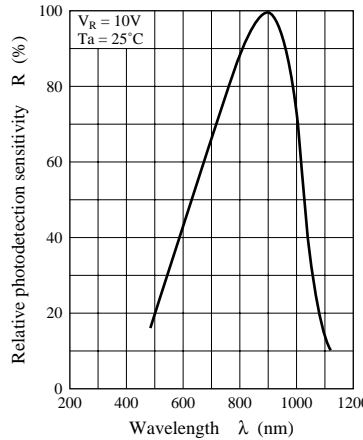

Frequency characteristics

