

2SK2339

Silicon N-Channel Power F-MOS

■ Features

- Avalanche energy capability guaranteed
- Low ON-resistance
- No secondary breakdown
- Low-voltage drive

■ Applications

- Non-contact relay
- Solenoid drive
- Motor drive
- Control equipment
- Switching mode regulator

■ Absolute Maximum Ratings (T_c = 25°C)

Parameter	Symbol	Rating	Unit	
Drain-Source breakdown voltage	V _{DSS}	80±10	V	
Gate-Source voltage	V _{GSS}	±15	V	
Drain current	DC	I _D	±10	A
	Pulse	I _{DP}	±20	A
Avalanche energy capability	EAS *	62.5	mJ	
Allowable power dissipation	T _c = 25°C	P _D	30	W
	T _a = 25°C		1.3	
Channel temperature	T _{ch}	150	°C	
Storage temperature	T _{stg}	-55 to +150	°C	

* L= 5mH, I_L= 5A, 1 pulse

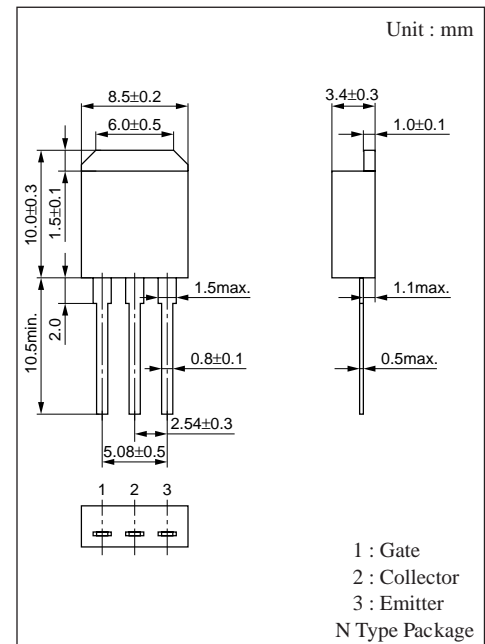

■ Equivalent Circuit

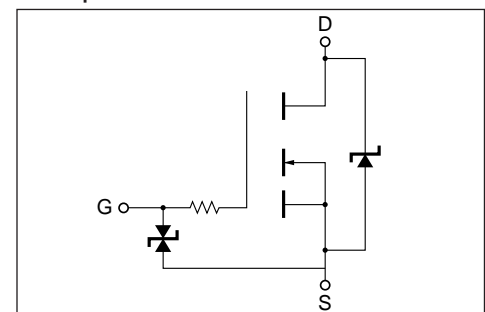

■ Electrical Characteristics (T_c = 25°C)

Parameter	Symbol	Condition	Min	Typ	Max	Unit
Drain-Source cut-off current	I _{DSS}	V _{DS} = 70V, V _{GS} = 0			10	μ A
Gate-Source leakage current	I _{GSS}	V _{DS} = 0, V _{GS} =15V			±10	μ A
Drain-Source breakdown voltage	V _{DSS}	I _D =1mA, V _{GS} = 0	70		90	V
Gate threshold voltage	V _{th}	V _{DS} =10V, I _D =1mA	1		2.5	V
Drain-Source ON-resistance	R _{DS(on)1}	V _{GS} =10V, I _D = 5A		150	230	mΩ
	R _{DS(on)2}	V _{GS} = 4V, I _D = 5A		230	370	mΩ
Forward transadmittance	Y _{fs}	V _{DS} =10V, I _D = 5A	3	5.5		S
Diode forward voltage	V _{DSF}	I _{DR} =10A, V _{GS} = 0			-1.8	V
Reverse recovery time	t _{rr}	L=230μ H, V _{DD} = 30V, V _{GS} = 0		0.55		μ s
Reverse recovery charge	Q _{rr}	I _{DR} =10A, di/dt= 80A/μ s		2.2		μ s
Input capacitance	C _{iss}	V _{DS} =10V, V _{GS} = 0, f= 1MHz		85		pF
Output capacitance	C _{oss}		250		pF	
Feedback capacitance	C _{rss}		20		pF	
Turn-on time	t _{on}			0.5		μ s
Fall time	t _f	V _{DD} = 30V, I _D = 5A		0.9		μ s
Turn-off time (delay time)	t _{d(off)}	V _{GS} =10V, R _L = 6Ω		1.9		μ s
Channel-Case heat resistance	R _{th(ch-c)}				4.2	°C/W
Channel-Atmosphere heat resistance	R _{th(ch-a)}				96	°C/W

Area of safe operation (ASO)

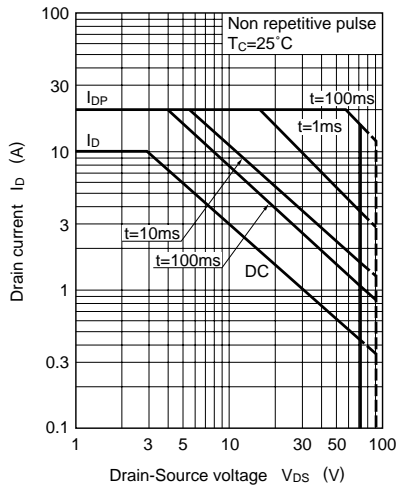

$P_D - T_a$

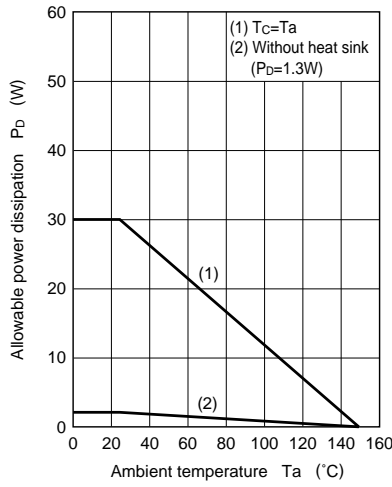

IAS - L-load

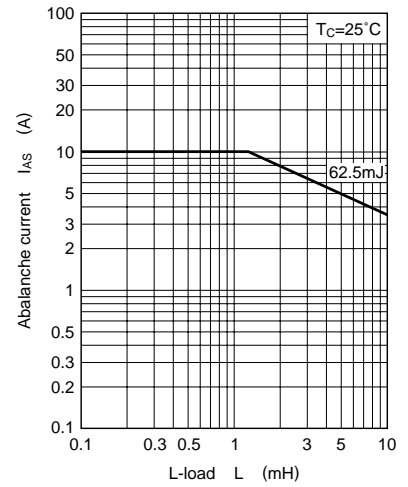

$I_D - V_{DS}$

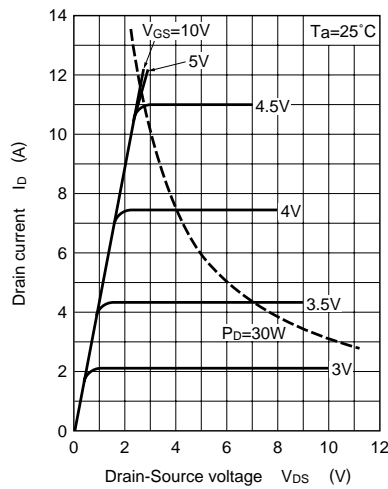

$I_D - V_{GS}$

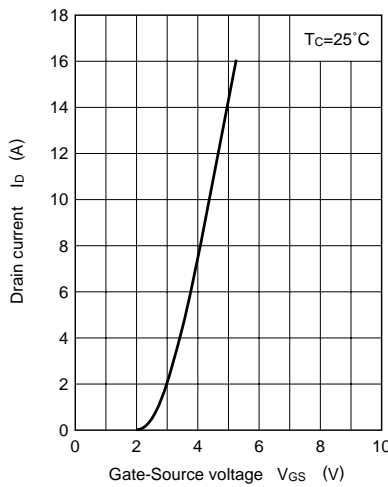

$V_{th} - T_C$

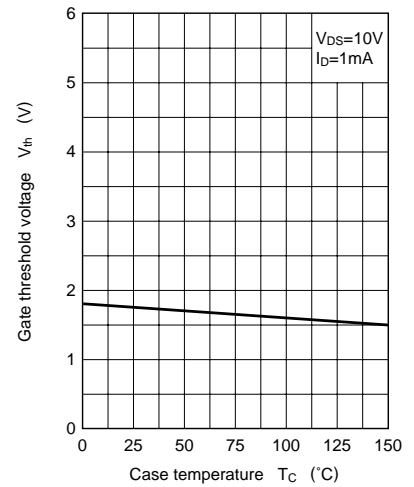

$R_{DS(on)} - I_D$

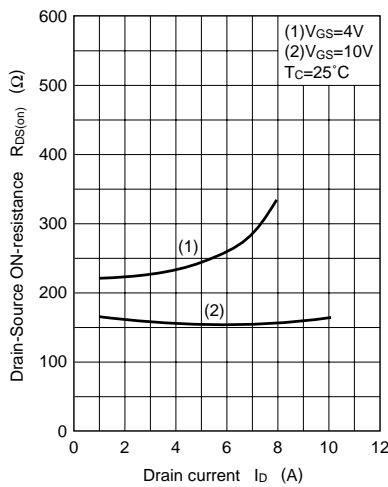

$R_{DS(on)} - V_{GS}$

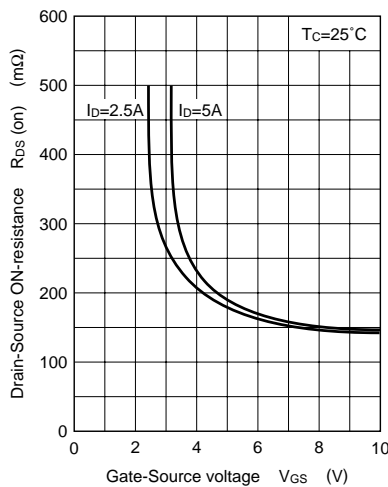

$|Y_{fs}| - I_D$

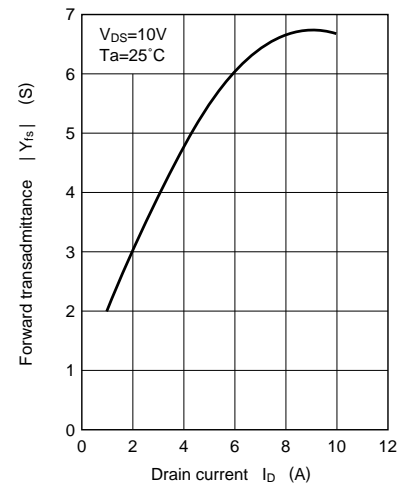

$C_{iss}, C_{oss}, C_{rss} - V_{DS}$

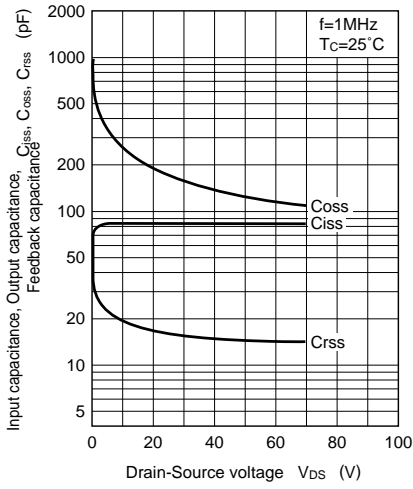

$t_{d(off)}, t_r, t_{on} - I_D$

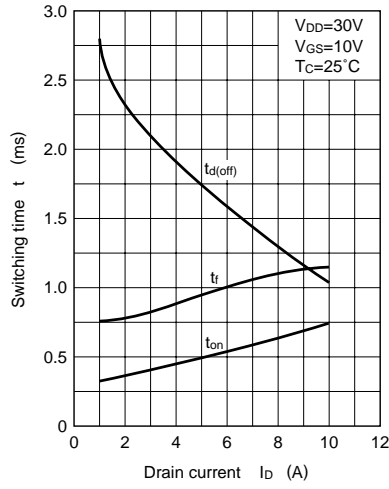

$V_{DS}, V_{GS} - Q_g$

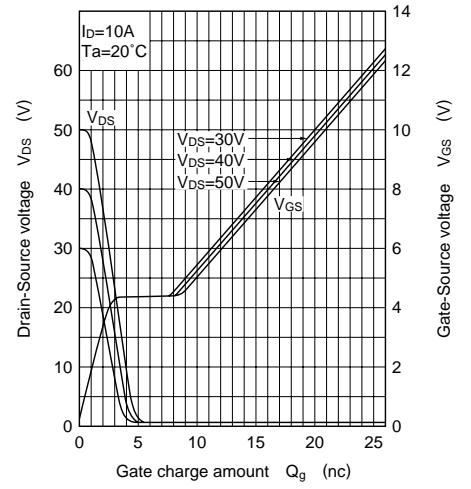

$I_{SD} - V_{SD}$

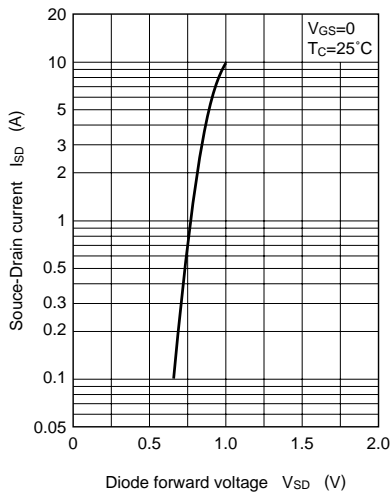

$R_{th} - t_p$

