

## 2SK3043

## Silicon N-Channel Power F-MOS FET

## ■ Features

- Avalanche energy capacity guaranteed: EAS > 100mJ
- $V_{GSS} = \pm 30V$  guaranteed
- High-speed switching:  $t_f = 35ns$
- No secondary breakdown

## ■ Applications

- Contactless relay
- Diving circuit for a solenoid
- Driving circuit for a motor
- Control equipment
- Switching power supply

■ Absolute Maximum Ratings ( $T_C = 25^\circ C$ )

Parameter	Symbol	Rated	Unit
Drain to Source breakdown voltage	$V_{DSS}$	450	V
Gate to Source voltage	$V_{GSS}$	$\pm 30$	V
Drain current	DC	$I_D$	$\pm 5$ A
	Pulse	$I_{DP}$	$\pm 10$ A
Avalanche energy capacity	EAS*	100	mJ
Allowable power dissipation	$T_C = 25^\circ C$	$P_D$	35
	$T_a = 25^\circ C$		2
Channel temperature	$T_{ch}$	150	$^\circ C$
Storage temperature	$T_{stg}$	-55 to +150	$^\circ C$

\*  $L = 8mH, I_L = 5A, V_{DD} = 50V, 1$  pulse

■ Electrical Characteristics ( $T_C = 25^\circ C$ )

Parameter	Symbol	Conditions	min	typ	max	Unit	
Drain to Source cut-off current	$I_{DSS}$	$V_{DS} = 360V, V_{GS} = 0$			0.1	mA	
Gate to Source leakage current	$I_{GSS}$	$V_{GS} = \pm 30V, V_{DS} = 0$			$\pm 1$	$\mu A$	
Drain to Source breakdown voltage	$V_{DSS}$	$I_D = 1mA, V_{GS} = 0$	450			V	
Gate threshold voltage	$V_{th}$	$V_{DS} = 25V, I_D = 1mA$	2		5	V	
Drain to Source ON-resistance	$R_{DS(on)}$	$V_{GS} = 10V, I_D = 3A$		1	1.3	$\Omega$	
Forward transfer admittance	$ Y_{fs} $	$V_{DS} = 25V, I_D = 3A$	1.8	2.5		S	
Diode forward voltage	$V_{DSF}$	$I_{DR} = 5A, V_{GS} = 0$			-1.2	V	
Input capacitance (Common Source)	$C_{iss}$	$V_{DS} = 20V, V_{GS} = 0, f = 1MHz$		700		pF	
Output capacitance (Common Source)	$C_{oss}$				100		pF
Reverse transfer capacitance (Common Source)	$C_{rss}$				40		pF
Turn-on time (delay time)	$t_{d(on)}$	$V_{GS} = 10V, I_D = 3A$ $V_{DD} = 150V, R_L = 50\Omega$		25		ns	
Rise time	$t_r$				45		ns
Turn-off time (delay time)	$t_{d(off)}$				80		ns
Fall time	$t_f$				35		ns

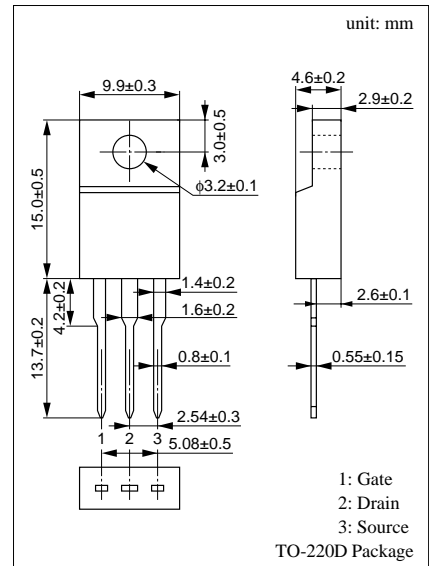

Area of safe operation (ASO)

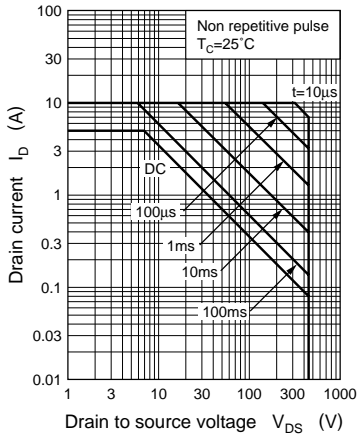

$P_D - T_a$

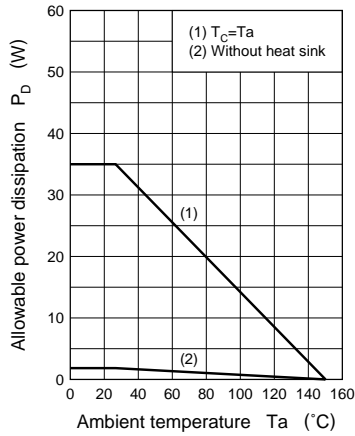

EAS —  $T_j$

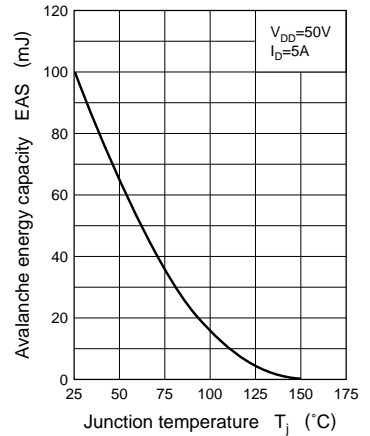

$I_D - V_{DS}$

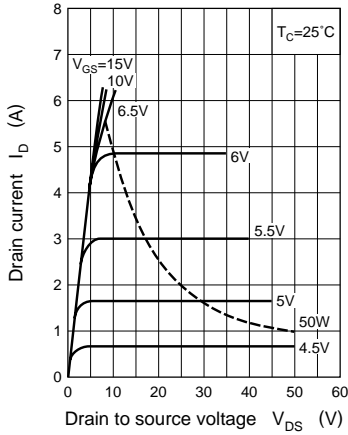

$I_D - V_{GS}$

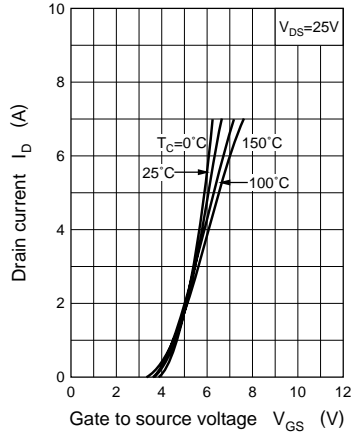

$V_{th} - T_C$

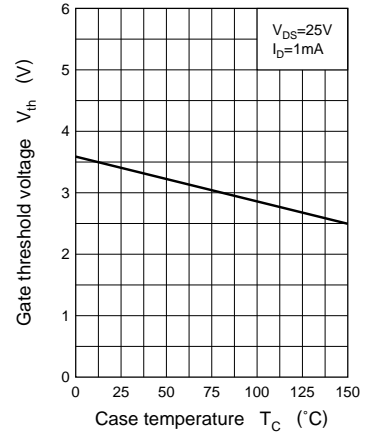

$V_{DS} - V_{GS}$

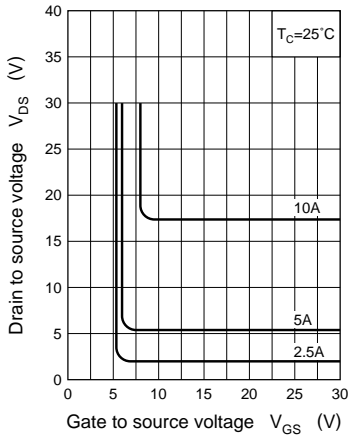

$R_{DS(on)} - I_D$

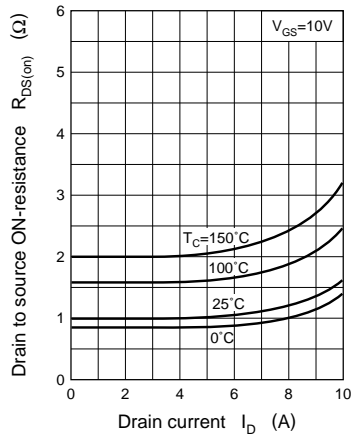

$|Y_{fs}| - I_D$

