

# AN5790N, AN5792

## Horizontal Signal Processing ICs for CRT Display

### Overview

The AN5790N and AN5792 are the intergrated circuits designed for CRT display horizontal signal processing circuits.

### Features

- Horizontal synchronous signal is available in both polarities.
- Wide range of horizontal oscillation frequency : 14kHz to 60kHz.
- Output pulse width : 2μs to 40μs
- Package
  - AN5790N...NF-12S(12-Pin SIL plastic package)
  - AN5792...F-12S (12-Pin SIL plastic package with fin)

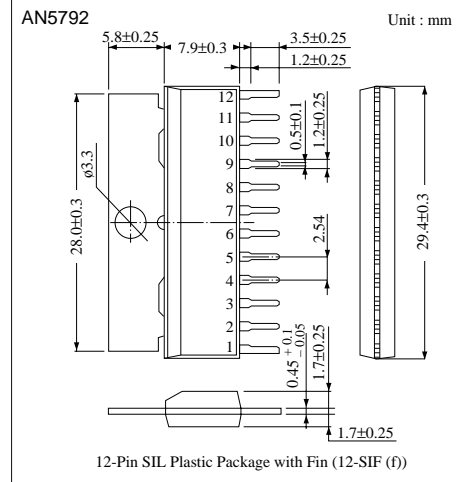
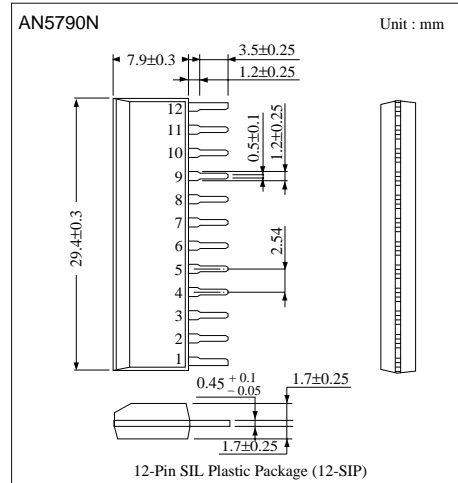

### Block Diagram

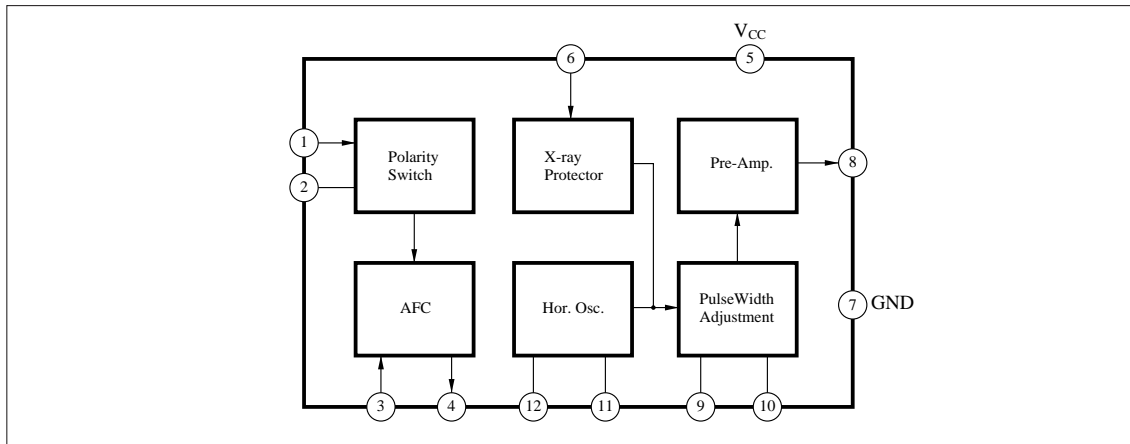

### ■ Absolute Maximum Ratings (Ta= 25°C)

Parameter		Symbol	Rating	Unit
Supply voltage		V <sub>CC</sub>	13.2	V
Supply current		I <sub>CC</sub>	50	mA
Power dissipation		P <sub>D</sub>	1140	mW
Temperature	Operating ambient temperature	T <sub>opr</sub>	- 20 to +70	°C
	Storage temperature	T <sub>stg</sub>	- 40 to +150	°C



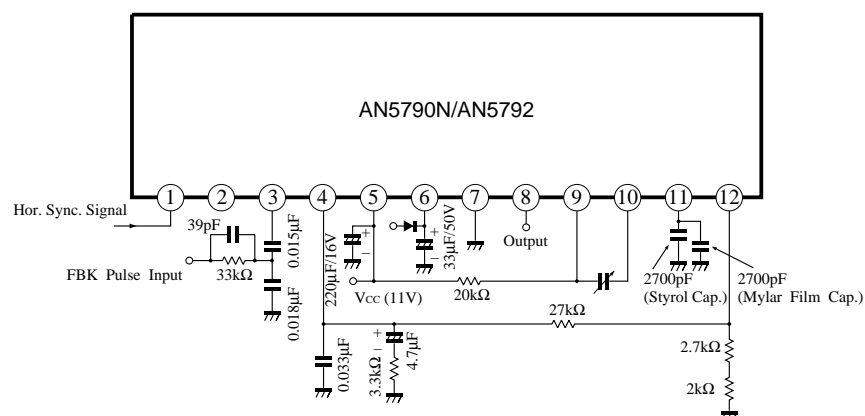

### ■ Electrical Characteristics (Ta= 25°C)

Parameter	Symbol	Condition	min	typ	max	Unit
Total circuit current	I <sub>tot</sub>	V <sub>CC</sub> =11V	30	45	60	mA
Polarity switching voltage (1)	V <sub>2-7</sub>	Positive polarity signal input	0	—	0.4	V
Polarity switching voltage (2)	V <sub>2-7</sub>	Negative polarity signal input	2.5	—	5.5	V
Horizontal oscillation start voltage	V <sub>OSC-S (H)</sub>	f <sub>HO</sub> =12kHz to 19kHz	7.5	—	—	V
Horizontal oscillation frequency	f <sub>HO (1)</sub>	V <sub>CC</sub> =11V, C= 4400pF	15	15.75	16.5	kHz
Horizontal oscillation frequency	f <sub>HO (2)</sub>	V <sub>CC</sub> =11V, C= 820pF, 5600pF	14	—	60	kHz
f <sub>HO</sub> supply voltage dependency	Δf <sub>HO</sub> /V <sub>CC</sub>	f <sub>HO</sub> =15.75kHz, f <sub>HO</sub>   9.9V - f <sub>HC</sub>   12.1V	—	40	130	Hz
f <sub>HO</sub> ambient temperature dependency	Δf <sub>HO</sub> /Ta	f <sub>HO</sub> =15.75kHz, f <sub>HO</sub>   -20°C - f <sub>HC</sub>   60°C	—	—	260	Hz
Oscillation frequency control sensitivity	β	ΔI <sub>O</sub> = ±25μA	16	17.6	19.3	Hz/μA
DC loop gain	f <sub>DC</sub>	μ × β	—	700	—	Hz/μs
Output pulse width	τ <sub>HO (1)</sub>	V <sub>CC</sub> =11V, R= 20kΩ, C= 6800pF	17.8	19.4	21.2	μs
Output pulse width	τ <sub>HO (2)</sub>	V <sub>CC</sub> =11V, R=20kΩ, C=330pF, 18000pF	2	—	40	μs
Output pulse width variation to supply voltage change	Δτ <sub>HO</sub> /V <sub>CC</sub>	V <sub>CC</sub> = 9.9V to 12.1V	—	—	5	%
Output pulse width variation to temperature change	Δτ <sub>HO</sub> /Ta	V <sub>CC</sub> =11V, Ta= - 20°C to + 60°C	—	—	5	%
Oscillation output saturation voltage	V <sub>8-7</sub>	V <sub>CC</sub> =11V, V <sub>I0-7</sub> =1V	—	—	2	V
Oscillation output drive current	I <sub>8-7</sub>	V <sub>CC</sub> =11V, V <sub>I0-7</sub> =1V	300	—	—	mA
X-ray protecting circuit operation start voltage	V <sub>6-7</sub>	V <sub>CC</sub> =11V	0.5	0.64	0.75	V

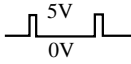
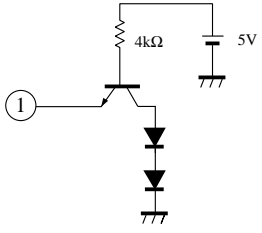
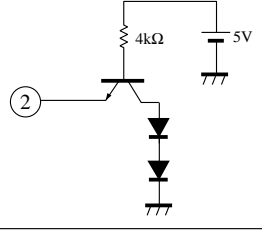

### ■ Application Circuit

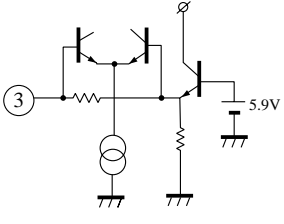
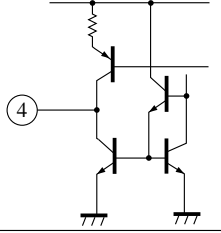
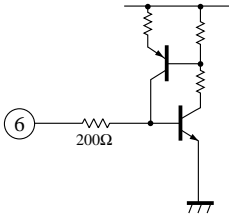

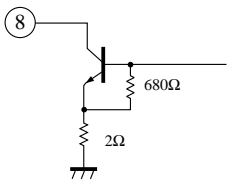
■ Pin Descriptions

Pin No.	Pin name	Typ. waveform	Description	Equivalent circuit
1	Horizontal synchronous signal input pin		Pin for inputting a horizontal synchronous signal.	
2	Polarity discrimination switching pin	DC	Both polarities of an input signal of Pin 1 are made available by connecting this pin to GND or setting it to OPEN	
3	Flyback pulse input pin		Flyback feedback pin. The standard value of amplitude is 1.5Vpp.	
4	AFC output pin	DC	Result of AFC detection.	
5	Supply voltage	DC	—————	—————
6	X-ray protecting circuit input pin	DC	When a voltage of 0.75V or more is applied, no horizontal output will not be generated.	
7	GND	DC	—————	—————
8	Horizontal drive output pin		Current when turned ON should be used at 300mA or less.	

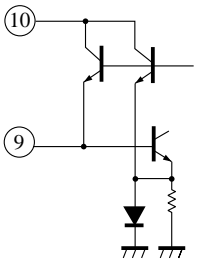
### ■ Pin Descriptions (cont.)

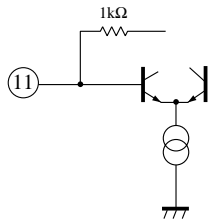
Pin No.	Pin name	Typ. waveform	Description	Equivalent circuit
9	Trigger input pin		The output pulse width can be changed by the capacitance between Pins9 and 10 and resistance between Pin10 and V <sub>CC</sub> .	
10	Pulse width adjusting pin			
11	Sawtooth wave generating pin		Oscillation frequency can be changed by the capacitor to be connected to this pin.	
12	Horizontal oscillation circuit reference voltage	DC	Oscillation frequency is changed by the resistor between this pin and GND.	