

# AN3266FAP

## Video luminance signal recording/playback processing IC

### ■ Overview

The AN3266FAP is a single chip IC in which the main signal processing part of VHS VCR luminance signal is integrated.

### ■ Features

- 5 V single power supply
- T2FP package

### ■ Applications

- VHS VCR, VHS video camera

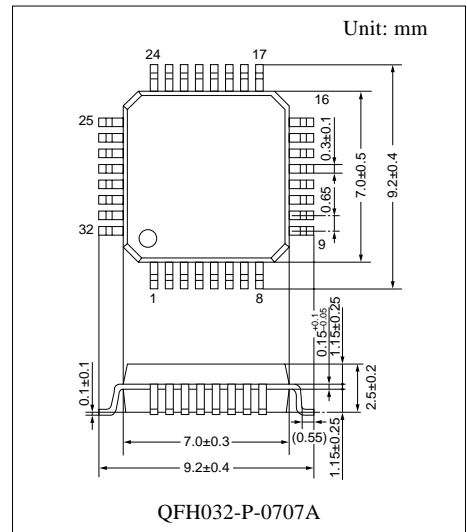

### ■ Block Diagram

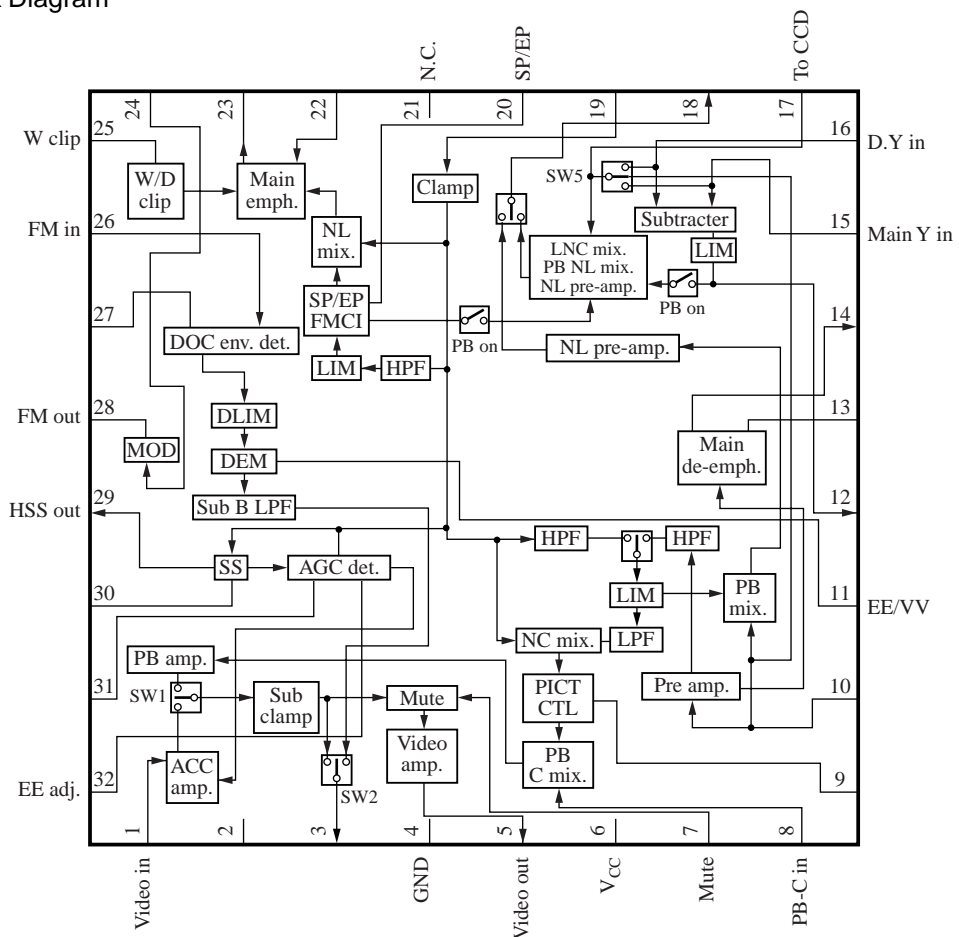

### ■ Pin Descriptions

Pin No.	Description	Pin No.	Description
1	Video in	17	To CCD out
2	Sub clamp det.	18	NL pre-emph. out
3	Sub clamp out (REC), Sub LPF out (PB)	19	Clamp in
4	GND	20	SP/EP select, FMCI CTL
5	Video out	21	N.C.
6	V <sub>CC</sub>	22	NF input for main emph.
7	Mute CTL	23	Main emph. out
8	PB chroma in / DE off CTL	24	FM current in
9	Picture CTL	25	W clip CTL / LNC stop CTL
10	Signal input for main LPF	26	PB RF in
11	VV level adjust., EE / VV select.	27	Env. det.
12	LNC LIM out	28	REC FM out
13	Main de-emphasis	29	Sync. sepa. out
14	Main de-emphasis (out)	30	Sync. sepa. det.
15	Main Y sig. in	31	AGC det.
16	Delayed Y sig. in	32	EE adjust / NC off CTL

### ■ Absolute Maximum Ratings

Parameter	Symbol	Rating	Unit
Supply voltage	V <sub>CC</sub>	6	V
Supply current	I <sub>CC</sub>	68	mA
Power dissipation *2	P <sub>D</sub>	208	mW
Operating ambient temperature *1	T <sub>opr</sub>	-20 to +70	°C
Storage temperature *1	T <sub>stg</sub>	-55 to +125	°C

Note) \*1: Except for the operating ambient temperature and storage temperature, all ratings are for T<sub>a</sub> = 25°C.









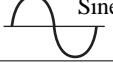

\*2: The power dissipation shown is for the IC package in free air at T<sub>a</sub> = 70°C.

P<sub>D</sub> = 417 mW (T<sub>a</sub> = 70°C) on mounting on a glass epoxy resin substrate of 50 × 50 × t0.8 mm<sup>3</sup>.

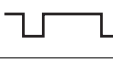



















### ■ Recommended Operating Range

Parameter	Symbol	Range	Unit
Supply voltage	V <sub>CC</sub>	4.5 to 5.5	V





















### ■ Electrical Characteristics at $T_a = 25^\circ\text{C}$

Parameter	Symbol	Conditions	Min	Typ	Max	Unit
Circuit current (REC)	$I_{CCR}$	REC mode	30	42	54	mA
Circuit current (PB)	$I_{CCP}$	PB mode	38	50	62	mA
EE mode hold voltage	$V_{EE}$	$V_6 = \text{Variable}$	0	—	1.25	V
VV mode hold voltage	$V_{VV}$	$V_6 = \text{Variable}$	2.25	—	5	V
SP mode hold voltage	$V_{SP}$	$V_8 = \text{Variable}$	0	—	1.25	V
EP mode hold voltage	$V_{EP}$	$V_8 = \text{Variable}$	2.25	—	5	V
FMCI off mode hold voltage	$V_{FM1}$	$V_A = \text{Variable}$	2.25	—	3.25	V
FMCI on mode hold voltage	$V_{FM2}$	$V_A = \text{Variable}$	4.25	—	5	V
EDIT mode hold voltage at PB	$V_{EDPB}$	$V_1 = \text{Variable}$	0	—	1.25	V
Mute CTL Through mode hold voltage	$V_{THRU(PB)}$	$V_1 = \text{Variable}$	0	—	1	V
Mute CTL Quasi H mode hold voltage	$V_{GRAY}$	$V_B = \text{Variable}$	2	—	3	V
Mute CTL Quasi V mode hold voltage	$V_{MUTE}$	$V_3 = \text{Variable}$	4	—	5	V
EDIT mode hold voltage at REC	$V_{EDREC}$	$V_4 = \text{Variable}$	0	—	1.25	V
Off mode hold voltage at LNC	$V_{LNC}$	$V_9 = \text{Variable}$	0	—	1.25	V
Through mode hold voltage at EE	$V_{THRU}$	$V_3 = \text{Variable}$	0	—	1	V
Quasi H gray level offset	$\Delta V_5$	PB mode	1.1	1.5	1.9	V
AGC output amplitude	$V_{1-5}$	 White 100% $V_{IN} = 1 \text{ V[p-p]}$	1.3	2.0	2.7	V[p-p]
AGC control sensitivity	$\Delta V_{1-5}$	 White 100% $V_{IN} = 1 \text{ V[p-p]}$	0	0.3	1.2	dB
Video amp. frequency characteristics	$f_{1-5}$	 Sine wave 5 MHz / 100 kHz $V_{IN} = 250 \text{ mV[p-p]}$	-1.2	-0.5	0.5	dB
Main emphasis output level	$V_{1-23}$	 White 100% $V_{IN} = 1 \text{ V[p-p]}$	260	300	340	mV[p-p]
D-clip level	$DV_{1-23}$	—	45	55	65	%
Keyed pulse width	$t_{W31}$	 Sync. sig. $V_{IN} = 287 \text{ mV[p-p]}$	4.6	5.8	7.0	$\mu\text{s}$
SS minimum input sensitivity	$S_{19}$	 White 100% $V_{IN}$ variable	—	—	450	mV[p-p]
SS pulse delay	$t_{F29}$	 $V_{IN} = 1 \text{ V[p-p]}$	460	660	860	ns
Over all gain for PB system	$G_{10-5}$	 White 100% $V_{IN} = 100 \text{ mV[p-p]}$	24	26	30	dB
Quasi V insertion step	$\Delta V_5$	 White 100% $V_{IN} = 100 \text{ mV[p-p]}$	20	70	120	mV
Chroma amp. gain	$G_{8-5}$	 Sine wave $V_{IN} = 200 \text{ mV[p-p]}$	7.6	9.1	10.6	dB

















■ Electrical Characteristics at  $T_a = 25^\circ\text{C}$  (continued)

Parameter	Symbol	Conditions	Min	Typ	Max	Unit
DE frequency characteristics 1 (0 dB)	$\Delta f_{10-18(1)}$	 Sine wave 500 kHz / 10 kHz $V_{IN} = 300 \text{ mV[p-p]}$	-0.5	0	1.0	dB
DE frequency characteristics 2 (0 dB)	$\Delta f_{10-18(2)}$	 Sine wave 2 MHz / 10 kHz $V_{IN} = 300 \text{ mV[p-p]}$	-0.5	0.15	1.15	dB
DE frequency characteristics 3 (-10 dB)	$\Delta f_{10-18(3)}$	 Sine wave 500 kHz / 10 kHz $V_{IN} = 94.9 \text{ mV[p-p]}$	-0.5	0.17	1.17	dB
DE frequency characteristics 4 (-10 dB)	$\Delta f_{10-18(4)}$	 Sine wave 2 MHz / 10 kHz $V_{IN} = 94.9 \text{ mV[p-p]}$	-0.5	0.45	1.45	dB
DE frequency characteristics 5 (-20 dB)	$\Delta f_{10-18(5)}$	 Sine wave 500 kHz / 10 kHz $V_{IN} = 30 \text{ mV[p-p]}$	-0.5	0.5	1.5	dB
DE frequency characteristics 6 (-20 dB)	$\Delta f_{10-18(6)}$	 Sine wave 2 MHz / 10 kHz $V_{IN} = 30 \text{ mV[p-p]}$	0.3	1.3	2.3	dB
DE frequency characteristics 7 (-30 dB)	$\Delta f_{10-18(7)}$	 Sine wave 500 kHz / 10 kHz $V_{IN} = 9.5 \text{ mV[p-p]}$	0	1.0	2.0	dB
DE frequency characteristics 8 (-30 dB)	$\Delta f_{10-18(8)}$	 Sine wave 2 MHz / 10 kHz $V_{IN} = 9.5 \text{ mV[p-p]}$	2.2	3.2	4.2	dB
DE off mode (-30 dB)	$\Delta G_{10-18}$	 Sine wave 2 MHz $V_{IN} = 9.5 \text{ mV[p-p]}$	-4.2	-3.2	-2.2	dB
REC NL frequency characteristics 1 (0 dB)	$\Delta f_{19-23(1)}$	 Sine wave $V_{IN} = 1 \text{ V[p-p]}$ SP 500 kHz / 10 kHz	-0.5	0.5	1.5	dB
REC NL frequency characteristics 2 (0 dB)	$\Delta f_{19-23(2)}$	 Sine wave $V_{IN} = 1 \text{ V[p-p]}$ SP 1.5 MHz / 10 kHz	0	1.0	2.0	dB
REC NL frequency characteristics 3 (-10 dB)	$\Delta f_{19-23(3)}$	 Sine wave $V_{IN} = 316 \text{ mV[p-p]}$ SP 500 kHz / 10 kHz	0	1.0	2.0	dB
REC NL frequency characteristics 4 (-10 dB)	$\Delta f_{19-23(4)}$	 Sine wave $V_{IN} = 316 \text{ mV[p-p]}$ SP 1.5 MHz / 10 kHz	1.3	2.3	3.3	dB
REC NL frequency characteristics 5 (-20 dB)	$\Delta f_{19-23(5)}$	 Sine wave $V_{IN} = 100 \text{ mV[p-p]}$ SP 500 kHz / 10 kHz	0.1	1.1	2.1	dB
REC NL frequency characteristics 6 (-20 dB)	$\Delta f_{19-23(6)}$	 Sine wave $V_{IN} = 100 \text{ mV[p-p]}$ SP 1.5 MHz / 10 kHz	2.1	3.1	4.1	dB
REC NL frequency characteristics 7 (0 dB)	$\Delta f_{19-23(7)}$	 Sine wave $V_{IN} = 1 \text{ V[p-p]}$ EP 500 kHz / 10 kHz	0.3	1.3	2.3	dB
REC NL frequency characteristics 8 (0 dB)	$\Delta f_{19-23(8)}$	 Sine wave $V_{IN} = 1 \text{ V[p-p]}$ EP 1.5 MHz / 10 kHz	1.3	2.3	3.3	dB
REC NL frequency characteristics 9 (-10 dB)	$\Delta f_{19-23(9)}$	 Sine wave $V_{IN} = 316 \text{ mV[p-p]}$ EP 500 kHz / 10 kHz	1.3	2.3	3.3	dB
REC NL frequency characteristics 10 (-10 dB)	$\Delta f_{19-23(10)}$	 Sine wave $V_{IN} = 316 \text{ mV[p-p]}$ EP 1.5 MHz / 10 kHz	3.3	4.3	5.3	dB
REC NL frequency characteristics 11 (-20 dB)	$\Delta f_{19-23(11)}$	 Sine wave $V_{IN} = 100 \text{ mV[p-p]}$ EP 500 kHz / 10 kHz	1.6	2.6	3.6	dB
REC NL frequency characteristics 12 (-20 dB)	$\Delta f_{19-23(12)}$	 Sine wave $V_{IN} = 100 \text{ mV[p-p]}$ EP 1.5 MHz / 10 kHz	5.6	6.0	7.0	dB













■ Electrical Characteristics at  $T_a = 25^\circ\text{C}$  (continued)

Parameter	Symbol	Conditions	Min	Typ	Max	Unit
PB NL frequency characteristics 1 (0 dB)	$\Delta f_{15-18(1)}$	 Sine wave $V_{IN} = 300\text{ mV[p-p]}$ SP 500 kHz / 10 kHz	-1.6	-0.6	0.4	dB
PB NL frequency characteristics 2 (0 dB)	$\Delta f_{15-18(2)}$	 Sine wave $V_{IN} = 300\text{ mV[p-p]}$ SP 1.5 MHz / 10 kHz	-2.0	-1.0	0	dB
PB NL frequency characteristics 3 (-10 dB)	$\Delta f_{15-18(3)}$	 Sine wave $V_{IN} = 94.9\text{ mV[p-p]}$ SP 500 kHz / 10 kHz	-2.1	-1.1	-0.1	dB
PB NL frequency characteristics 4 (-10 dB)	$\Delta f_{15-18(4)}$	 Sine wave $V_{IN} = 94.9\text{ mV[p-p]}$ SP 1.5 MHz / 10 kHz	-3.5	-2.5	-1.5	dB
PB NL frequency characteristics 5 (-20 dB)	$\Delta f_{15-18(5)}$	 Sine wave $V_{IN} = 30\text{ mV[p-p]}$ SP 500 kHz / 10 kHz	-2.2	-1.2	-0.2	dB
PB NL frequency characteristics 6 (-20 dB)	$\Delta f_{15-18(6)}$	 Sine wave $V_{IN} = 30\text{ mV[p-p]}$ SP 1.5 MHz / 10 kHz	-4.2	-3.2	-2.2	dB
PB NL frequency characteristics 7 (0 dB)	$\Delta f_{15-18(7)}$	 Sine wave $V_{IN} = 300\text{ mV[p-p]}$ EP 500 kHz / 10 kHz	-2.3	-1.3	-0.3	dB
PB NL frequency characteristics 8 (0 dB)	$\Delta f_{15-18(8)}$	 Sine wave $V_{IN} = 300\text{ mV[p-p]}$ EP 1.5 MHz / 10 kHz	-3.3	-2.3	-1.2	dB
PB NL frequency characteristics 9 (-10 dB)	$\Delta f_{15-18(9)}$	 Sine wave $V_{IN} = 94.9\text{ mV[p-p]}$ EP 500 kHz / 10 kHz	-3.3	-2.3	-1.3	dB
PB NL frequency characteristics 10 (-10 dB)	$\Delta f_{15-18(10)}$	 Sine wave $V_{IN} = 94.9\text{ mV[p-p]}$ EP 1.5 MHz / 10 kHz	-6.0	-5.0	-4.0	dB
PB NL frequency characteristics 11 (-20 dB)	$\Delta f_{15-18(11)}$	 Sine wave $V_{IN} = 30\text{ mV[p-p]}$ EP 500 kHz / 10 kHz	-3.5	-2.5	-1.5	dB
PB NL frequency characteristics 12 (-20 dB)	$\Delta f_{15-18(12)}$	 Sine wave $V_{IN} = 30\text{ mV[p-p]}$ EP 1.5 MHz / 10 kHz	-6.7	-5.7	-4.7	dB
NC frequency characteristics 1 (0 dB)	$\Delta f_{19-5(1)}$	 Sine wave $V_{IN} = 1\text{ V[p-p]}$ 1 MHz / 10 kHz	-1.4	-0.4	0.6	dB
NC frequency characteristics 2 (0 dB)	$\Delta f_{19-5(2)}$	 Sine wave $V_{IN} = 1\text{ V[p-p]}$ 2 MHz / 1 MHz	-1.1	-0.1	0.9	dB
NC frequency characteristics 3 (-10 dB)	$\Delta f_{19-5(3)}$	 Sine wave $V_{IN} = 316\text{ mV[p-p]}$ 1 MHz / 10 kHz	-2.0	-1.0	0	dB
NC frequency characteristics 4 (-10 dB)	$\Delta f_{19-5(4)}$	 Sine wave $V_{IN} = 316\text{ mV[p-p]}$ 2 MHz / 1 MHz	-0.8	0.2	1.2	dB
NC frequency characteristics 5 (-20 dB)	$\Delta f_{19-5(5)}$	 Sine wave $V_{IN} = 100\text{ mV[p-p]}$ 1 MHz / 10 kHz	-3.3	-2.3	-1.3	dB
NC frequency characteristics 6 (-20 dB)	$\Delta f_{19-5(6)}$	 Sine wave $V_{IN} = 100\text{ mV[p-p]}$ 2 MHz / 1 MHz	-0.5	0.5	1.5	dB
NC frequency characteristics 7 (-30 dB)	$\Delta f_{19-5(7)}$	 Sine wave $V_{IN} = 31.6\text{ mV[p-p]}$ 1 MHz / 10 kHz	-10	-6.3	-4.3	dB
NC frequency characteristics 8 (-30 dB)	$\Delta f_{19-5(8)}$	 Sine wave $V_{IN} = 31.6\text{ mV[p-p]}$ 2 MHz / 1 MHz	0.2	2.2	6.2	dB
NC off mode	$\Delta G_{19-5}$	 Sine wave $V_{IN} = 31.6\text{ mV[p-p]}$ 1 MHz	4.3	6.3	10.0	dB

■ Electrical Characteristics at  $T_a = 25^\circ\text{C}$  (continued)

Parameter	Symbol	Conditions	Min	Typ	Max	Unit
LNC attenuation level 1	$\Delta G_{15-18(1)}$	(19 input off)  Sine wave (19 input on) 10 kHz	-12.3	-9.3	-5	dB
LNC attenuation level 2	$\Delta G_{15-18(2)}$	(19 input off)  Sine wave (19 input on) 3 kHz	-8.1	-6.1	-3.1	dB
LNC off mode	$\Delta V_{15-18}$	 Sine wave $V_9$ 1.35 V 2.15 V 10 kHz	-1	0	1	dB
LNC LIM output amplitude	$V_{LNC}$	 Sine wave $V_{IN} = 300$ mV[p-p] 100 kHz	34	44	58	mV[p-p]
LNC LIM gain	$G_{LNC}$	 Sine wave $V_{IN} = 9.5$ mV[p-p] 100 kHz	3.7	6.7	8.7	mV[p-p]
Pic. cont. frequency characteristics 1 (forced)	$\Delta f_{19-5(1)}$	 Sine wave $V_{IN} = 500$ mV[p-p] 3 MHz / 100 kHz	4.9	5.9	7.4	dB
Pic. cont. frequency characteristics 2 (attenuated)	$\Delta f_{19-5(2)}$	 Sine wave $V_{IN} = 1$ V[p-p] 3 MHz / 100 kHz	-14	-11	-8	dB
FM oscillation output amplitude	$V_{28}$	$I_{IN} = 280$ $\mu\text{A}$	0.85	1.0	1.3	V[p-p]
FM oscillation secondary harmonic	$2f_{28}$	$I_{IN} = 280$ $\mu\text{A}$	—	—	-33	dB
FM oscillation frequency	$f_{28}$	$I_{IN} = 280$ $\mu\text{A}$	3.1	3.5	3.9	MHz
FM oscillation control sensitivity	$\beta_{28}$	$\frac{f(500 \mu\text{A}) - f(160 \mu\text{A})}{500 \mu\text{A} - 160 \mu\text{A}}$	11.5	13	15.0	MHz/ $\mu\text{A}$
FM carrier interleave 1	$\Delta V_{20-23}$	 $V_{IN} = 5$ V[p-p]	1.35	2.35	3.35	mV[p-p]
DEM demodulation sensitivity 1	$S_{3(1)}$	 Sine wave $V_5 = 2.5$ V $V_{IN} = 350$ mV[p-p] $f_{IN} = 3$ MHz to 5 MHz	40	69	100	mV/MHz
DEM demodulation sensitivity 2	$S_{3(2)}$	 Sine wave $V_5 = 3.5$ V $V_{IN} = 350$ mV[p-p] $f_{IN} = 3$ MHz to 5 MHz	75	105	135	mV/MHz
DEM demodulation limit	$Lf_{26-3}$	 Sine wave $V_{IN} = 350$ mV[p-p]	7.5	—	—	MHz
DEM carrier leak	$CL_{26-3}$	 Sine wave $V_{IN} = 350$ mV[p-p] $f_{IN} = 2$ MHz $\rightarrow$ 2 MHz / 4 MHz	—	—	-25	dB
Sub LPF frequency characteristics	$\Delta f_{26-3}$	 Sine wave $f_{IN}$ $V_{IN} = 350$ mV[p-p]	-8	-6.2	-4.5	dB
DOC det. on	$S_{26}$	 Sine wave $f_{IN} = 4$ MHz	-20	-16	-11	dB
DOC det. off (hysteresis)	$\Delta S_{26}$	 Sine wave $f_{IN} = 4$ MHz	0.2	1.5	6	dB
DOC offset	$\Delta V_{18}$	 $V_{IN} = 350$ mV[p-p] or 0 mV[p-p] $f_{IN} = 4$ MHz	-15	0	15	mV[p-p]

**■ Electrical Characteristics at  $T_a = 25^\circ\text{C}$  (continued)**

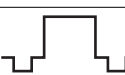
Parameter	Symbol	Conditions	Min	Typ	Max	Unit
DOC pulse width	$t_{W18}$	 $V_{IN} = 350 \text{ mV[p-p]}$ or $0 \text{ mV[p-p]}$ $f_{IN} = 4 \text{ MHz}$	35.5	37.45	39.5	$\mu\text{s}$
DOC SW crosstalk	$CT_{16-17}$	 Sine wave DOC off $V_{IN} = 300 \text{ mV[p-p]}$ $f_{IN} = 100 \text{ kHz}$	—	—	-35	dB
Quasi V mute crosstalk	$CT_{19-5}$	 Sine wave $V_{IN} = 1 \text{ V[p-p]}$ $f_{IN} = 2 \text{ MHz}$	—	—	-35	dB
SW1 crosstalk 1	$CT_{19-5}$	 Sine wave $V_{IN} = 1 \text{ V[p-p]}$ $f_{IN} = 2 \text{ MHz}$	—	—	-40	dB
SW1 crosstalk 2	$CT_{1-5}$	 Sine wave $V_{IN} = 250 \text{ mV[p-p]}$ $f_{IN} = 2 \text{ MHz}$	—	—	-40	dB
SW2 crosstalk 1	$CT_{26-3}$	 Sine wave PB 2 MHz $V_{IN} = 350 \text{ mV[p-p]}$ REC 4 MHz	—	—	-40	dB
SW2 crosstalk 2	$CT_{1-3}$	 Sine wave $V_{IN} = 250 \text{ mV[p-p]}$ $f_{IN} = 2 \text{ MHz}$	—	—	-40	dB
SW5 crosstalk 1	$CT_{15-18}$	 Sine wave $V_{IN} = 250 \text{ mV[p-p]}$ $f_{IN} = 2 \text{ MHz}$	—	—	-40	dB
SW5 crosstalk 2	$CT_{17-18}$	 Sine wave $V_{IN} = 300 \text{ mV[p-p]}$ $f_{IN} = 2 \text{ MHz}$	—	—	-40	dB
White mute crosstalk	$CT_{1-5}$	 Sine wave $V_{IN} = 300 \text{ mV[p-p]}$ $f_{IN} = 2 \text{ MHz}$	—	—	-40	mV[p-p]
FM carrier interleave 2	$\Delta V_{20-18}$	 Sine wave $V_{IN} = 5 \text{ V[0-p]}$ $f_{IN} = 2 \text{ MHz}$	4	7.5	1	mV
Pi cont. off mode	$\Delta G_{19-5}$	 Sine wave $V_{IN} = 1 \text{ V[p-p]}$ $f_{IN} = 3 \text{ MHz}$	4.4	5.9	7.4	dB
SS pulse output amplitude	$V_{29}$	 White 100% $V_{IN} = 1 \text{ V[p-p]}$	4.3	—	—	V[p-p]

