

DATA SHEET



PCF8558

Universal LCD driver for small graphic panels

Objective specification
Supersedes data of 1997 Feb 27
File under Integrated Circuits, IC12

1998 Apr 07

Universal LCD driver for small graphic panels

PCF8558

FEATURES

- Single-chip LCD controller/driver
- 40 row and 101 column outputs
- Display data RAM
40 × 101 bits = 505 bytes = 4040 bits
- On-chip:
 - Generation of intermediate LCD bias voltages
 - Oscillator requires no external components
(external clock also possible)
- 400 kHz fast I²C-bus interface
- CMOS compatible
- MUX rate 1 : 40
- Logic supply voltage range $V_{DD} - V_{SS} = 2.5$ to 6 V
- Display supply voltage range $V_{DD} - V_{LCD} = 3.5$ to 9 V
- Low power consumption, suitable for battery operated systems.



GENERAL DESCRIPTION

The PCF8558 is a low power CMOS LCD controller driver, designed to drive a graphic display of 40 rows and 101 columns. All necessary functions for the display are provided in a single chip, including on-chip generation of LCD bias voltages, resulting in a minimum of external components and lower power consumption.

The PCF8558 interfaces to most microcontrollers via a I²C-bus interface.

APPLICATIONS

- Telecom equipment
- Portable instruments
- Point of sale terminals
- Alarm systems.

ORDERING INFORMATION

TYPE NUMBER	PACKAGE ⁽¹⁾		
	NAME	DESCRIPTION	VERSION
PCF8558U/10	–	chip on FFC	–
PCF8558U/12	–	chip with bumps on FFC	–

Note

1. For further details see Chapter "Bonding pad locations".

Universal LCD driver for small graphic panels

PCF8558

BLOCK DIAGRAM

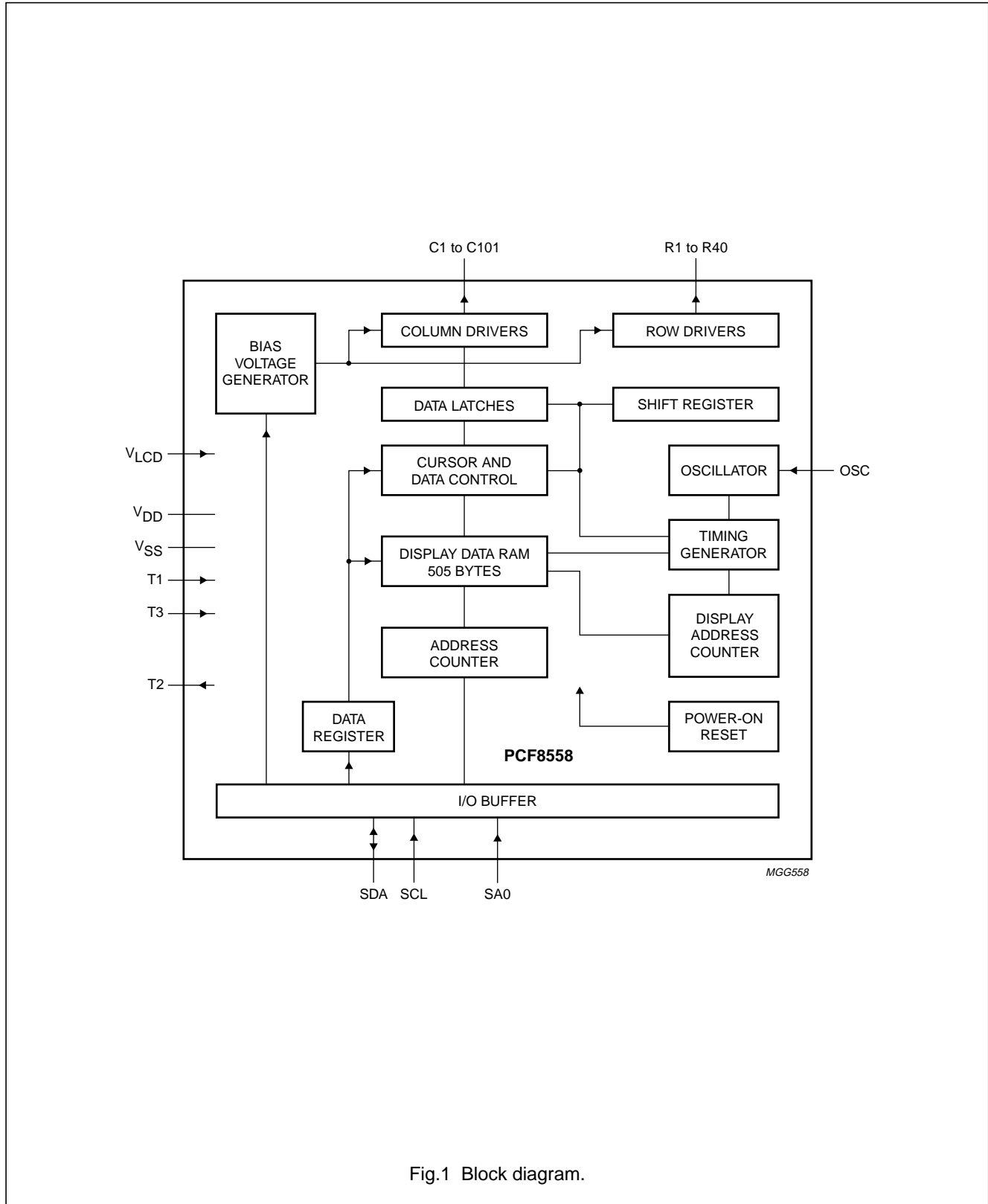

Fig.1 Block diagram.

Universal LCD driver for small graphic panels

PCF8558

PINNING

SYMBOL	PAD	DESCRIPTION
SCL	1	I ² C-bus serial clock input
R20 to R1	2 to 21	LCD row driver data outputs
C101 to C1	22 to 122	LCD column driver data outputs
R21 to R40	123 to 142	LCD row driver data outputs
T2	143	test pad output, must be left unconnected (not user accessible)
SDA	144	I ² C-bus serial data input/output
V _{SS}	145	ground
T1	146	test pad input, must be connected to V _{SS} (not user accessible)
V _{LCD}	147	negative supply voltage input
SA0	148	the LSB bit of the I ² C-bus slave address input is set by connecting this pin to either 0 (V _{SS}) or 1 (V _{DD})
T3	149	test pad input, must be connected to V _{DD} (not user accessible)
OSC	150	when the on-chip oscillator is used this pin must be connected to V _{DD} ; an external clock signal, if used, is input at this pin
V _{DD}	151	positive supply voltage

Universal LCD driver for small graphic panels

PCF8558

FUNCTIONAL DESCRIPTION

LCD bias voltage generator

The intermediate bias voltages for the LCD display are generated and buffered on-chip. This removes the need for an external resistor bias chain and significantly reduces the system power consumption.

Oscillator

The on-chip oscillator provides the clock signal for the display system. No external components are required and the OSC pin must be connected to V_{DD} .

External clock

If an external clock is to be used it is input at the OSC pin. The resulting display frame frequency is given by

$$f_{\text{frame}} = \frac{f_{\text{OSC}}}{3072}$$

Only in the power-down state is the clock allowed to be stopped (OSC connected to V_{SS}), otherwise the LCD will be frozen in a state where a DC voltage is applied to it.

Power-on reset

The on-chip power-on reset block initializes the chip after power-on or power failure. This is a synchronous reset and requires 2 oscillator cycles to execute. These oscillator cycles must be provided from the external clock source if the internal oscillator is not used. If this is not done, the device may not respond to command sequences transmitted via the I²C-bus interface.

Power-down

The chip can be put into power-down mode where all static currents are switched off (no internal oscillator, no internal power-on reset, no bias level generation and all LCD outputs are internally connected to V_{DD}) when PD = logic 1.

During power-down the information in the RAMs and the internal chip states are preserved. Instruction execution during power-down is possible if an externally clock signal is applied to pad OSC.

Registers

The PCF8558 has one 8-bit register, time shared as a Command Register (CR) and a Data Register (DR). The command register stores the command code such as display on or display off and address information for the

Display Data RAM (DDRAM). Both registers can be written to but not read from by the system controller.

Address Counter (AC)

The address counter assigns addresses to the DDRAM for writing and is set by Y2 to Y0 in the command and X6 to X0 in the address. After a write operation the address counter is automatically incremented by 1 in accordance with the V flag.

Display Data RAM (DDRAM)

The PCF8558 contains a 40 × 101-bit static RAM which stores the display data. The RAM is divided into 5 banks of 101 bytes (5 × 8 × 101 bits). During RAM access, data is transferred to the RAM via the I²C-bus. There is a direct correspondence between the X address and the column output number.

Timing generator

The timing generator produces the various signals required to drive the internal circuitry. Internal chip operation is not disturbed by operations on the data buses.

Display control

The display is generated by continuously shifting rows of RAM data to the dot matrix LCD via the column outputs.

The display status (all dots on/off and normal/inverse video) is set by bits E and D in the command word.

LCD row and column drivers

The PCF8558 contains 40 row and 101 column drivers, which connect the appropriate LCD bias voltages in sequence to the display in accordance with the data to be displayed. Figure 3 illustrates typical waveforms. Unused outputs should be left unconnected.

The bias voltage levels, V2 to V5, are chosen to give optimum display contrast for a multiplex rate of 1 : 40.

Table 1 Voltage bias levels

LEVEL	VOLTAGE
V2	$0.8635 \times (V_{DD} - V_{LCD})$
V3	$0.7270 \times (V_{DD} - V_{LCD})$
V4	$0.2730 \times (V_{DD} - V_{LCD})$
V5	$0.1365 \times (V_{DD} - V_{LCD})$

Universal LCD driver for small graphic panels

PCF8558

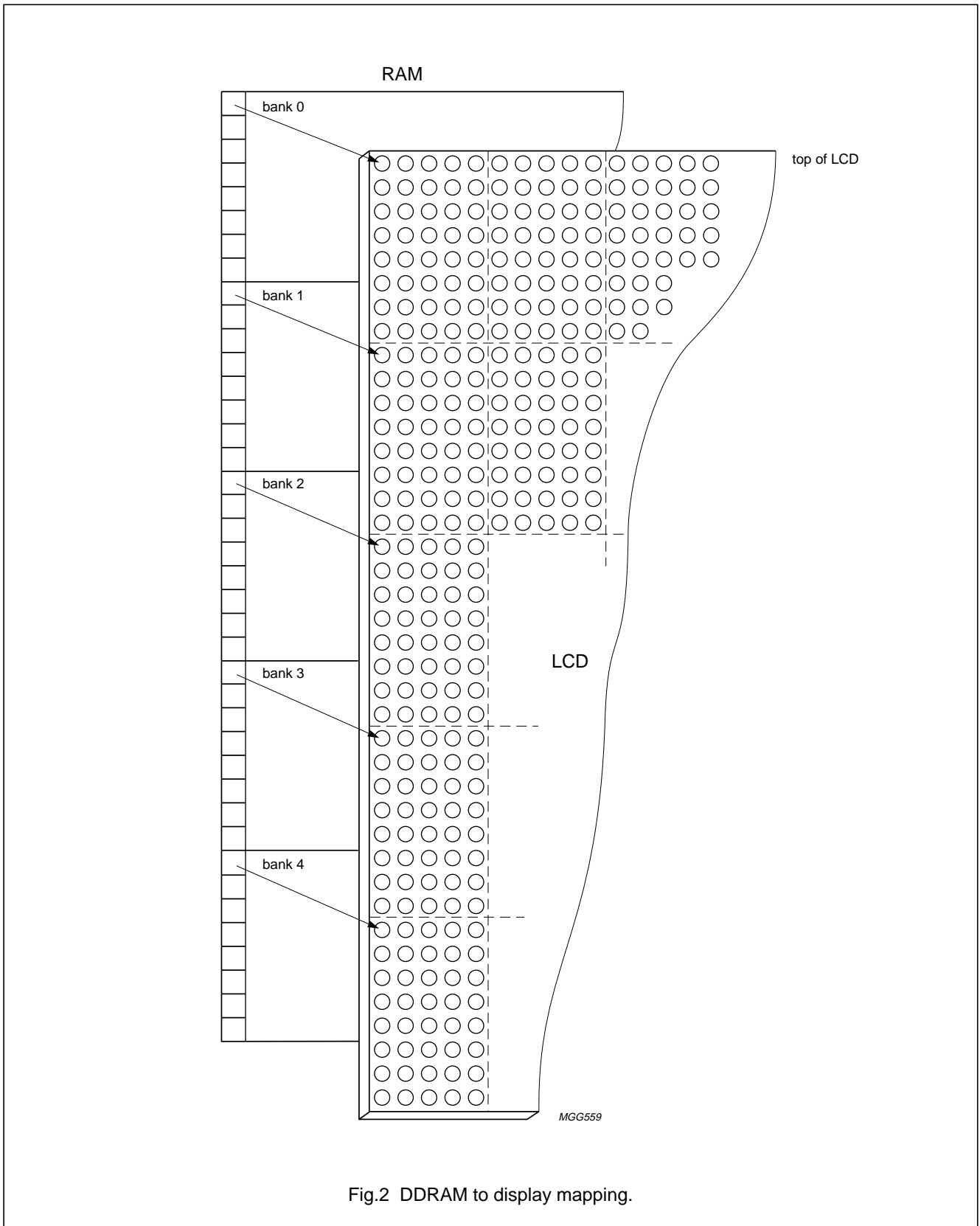
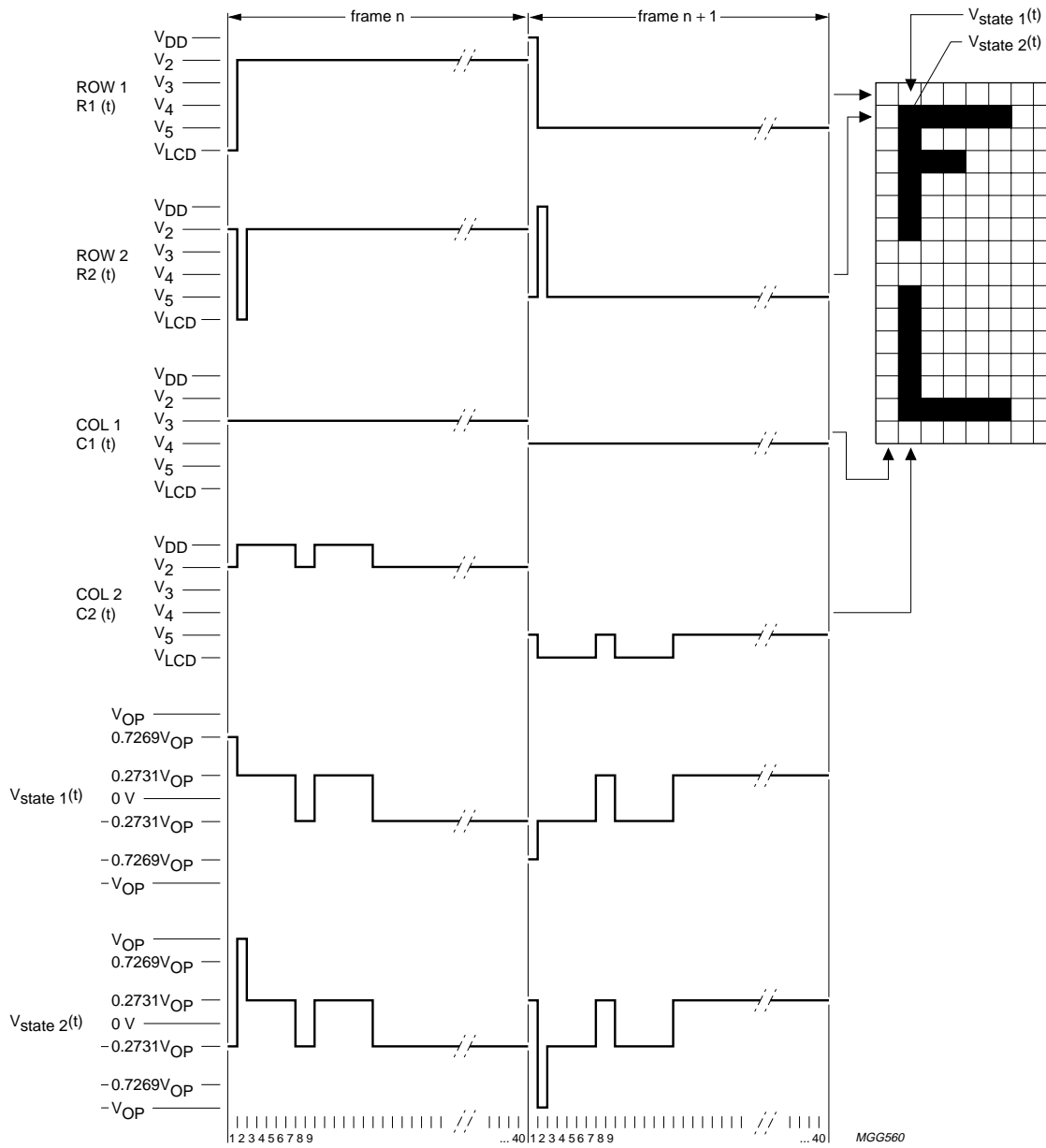

Fig.2 DDRAM to display mapping.

Universal LCD driver for small graphic panels

PCF8558



$V_{state1}^{(t)} = C2^{(t)} - R1^{(t)}$; $V_{state2}^{(t)} = C2^{(t)} - R2^{(t)}$.

Fig.3 Typical LCD driver waveforms (MUX rate 1 : 40).

Universal LCD driver for small graphic panels

PCF8558

ADDRESSING

The data is downloaded into the matrix of the PCF8558 as indicated in Figs 4 and 5.

The display RAM has a matrix of 40 by 101 bits (5 by 101 bytes). The columns are addressed by the address pointer. After writing one byte the pointer is set to the next byte. Control of address increment, horizontal or vertical, is by bit V in the command byte.

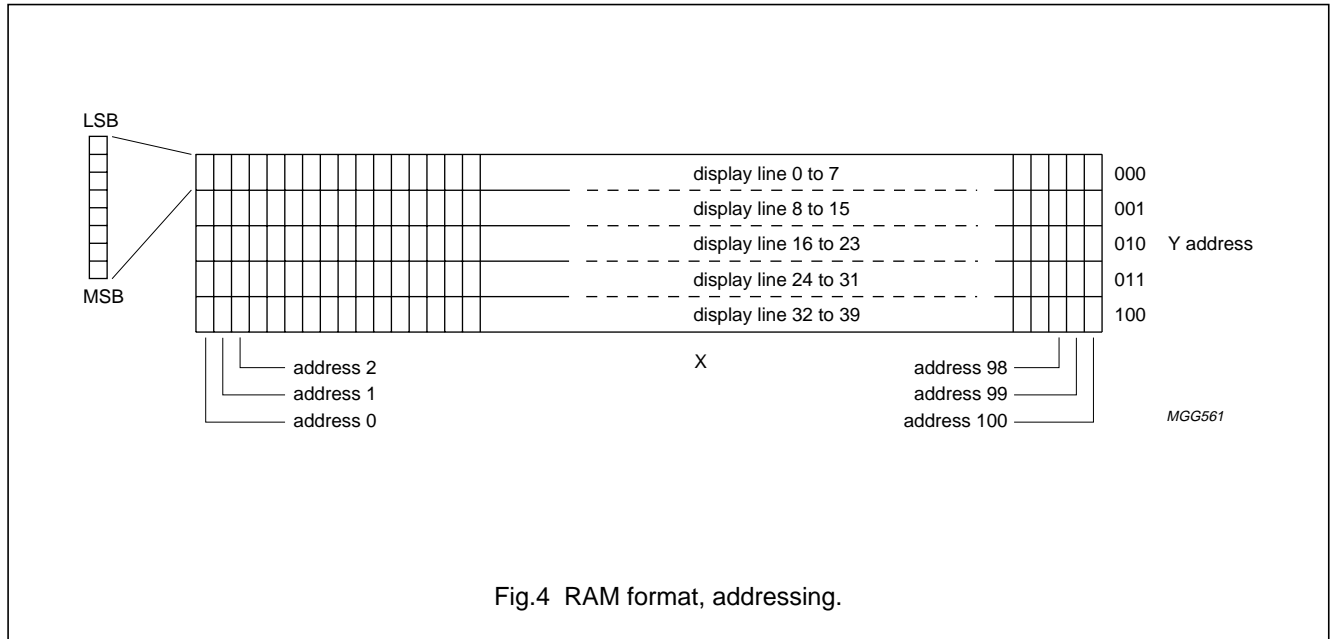

DATA STRUCTURE

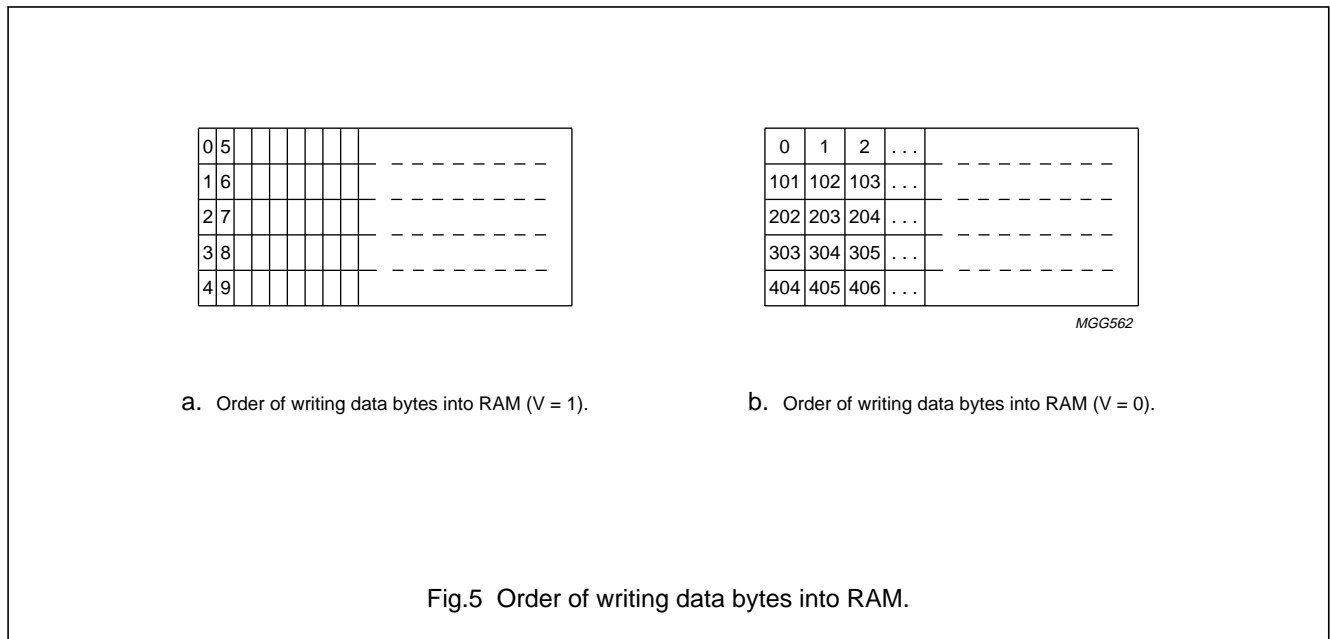

Universal LCD driver for small graphic panels

PCF8558

I²C-BUS PROTOCOL

Two 7-bit slave addresses (0111100 and 0111101) are reserved for both the PCF8558. The least-significant bit of the slave address is set by connecting input SA0 to either 0 (V_{SS}) or 1 (V_{DD}). Therefore, two PCF8558 can be used on the same I²C-bus allowing displays of up to 80 × 101 or 40 × 202 dots to be driven.

The I²C-bus protocol is shown in Fig.6. All communications are initiated with a START condition (S) from the I²C-bus master, which is followed by the desired slave address and write bit. All devices with this slave address acknowledge in parallel. All other devices ignore the bus transfer.

In write mode (indicated by setting the read/write bit LOW) one or more commands follow the slave address acknowledgement. The commands are also acknowledged by all addressed devices on the bus. The last command must clear the continuation bit C. After the last command a series of data bytes may follow. The acknowledgement after each byte is made only by the addressed device. After the last data byte has been acknowledged, the I²C-bus master issues a STOP condition (P).

For PCF8558, no read mode is provided.

Display bytes are written into the RAM at the address specified by the data pointer and subaddress counter. Both the data pointer and subaddress counter are

automatically incremented, enabling a stream of data to be transferred to the DDRAM.

The instruction format is composed of I²C-bus slave address followed by one command byte, one X address pointer, followed by any number of data bytes.

Command execution/storing of data takes place during the acknowledge cycle.

Definitions

- Transmitter: the device which sends the data to the bus
- Receiver: the device which receives the data from the bus
- Master: the device which initiates a transfer, generates clock signals and terminates a transfer
- Slave: the device addressed by a master
- Multi-master: more than one master can attempt to control the bus at the same time. The I²C-bus can accommodate this without data los/contention.
- Arbitration: procedure to ensure that, if more than one master simultaneously tries to control the bus, only one is allowed to do so and the message is not corrupted
- Synchronization: procedure to synchronize the clock signals of two or more devices.

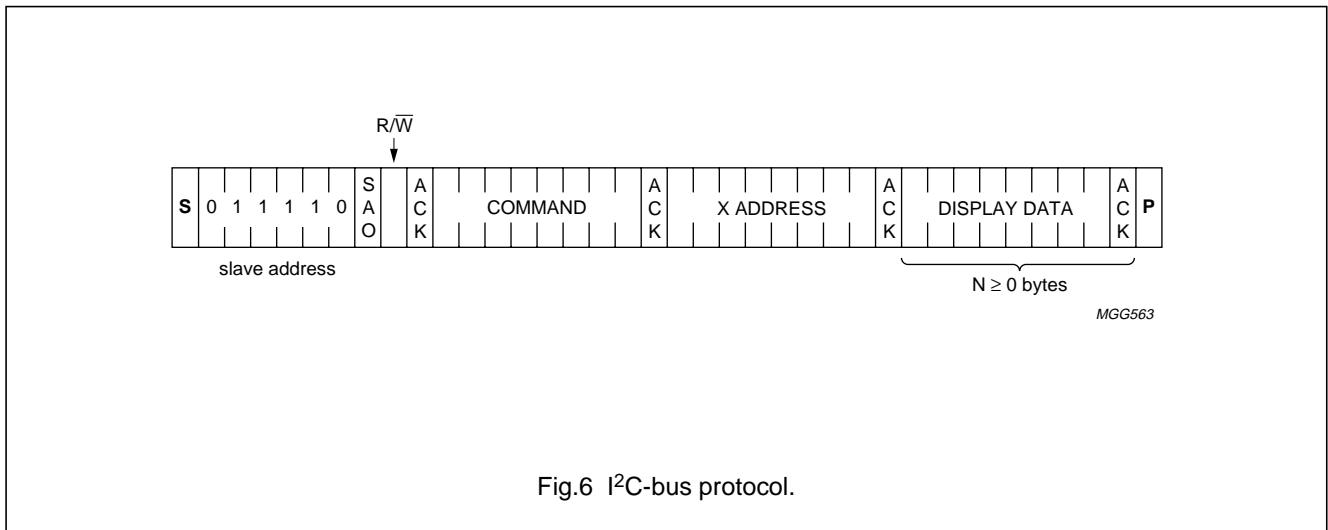

Fig.6 I²C-bus protocol.

Universal LCD driver for small graphic panels

PCF8558

COMMANDS

Display Control

BIT	LOGIC 0	LOGIC 1
PD	normal	power-down
V	horizontal addressing	vertical addressing

Table 2 Display status

DISPLAY STATUS	BITS	
	E	D
Blank	0	0
Normal	1	1
All segments on	1	0
Inverse video	0	1

PD: POWER-DOWN

- All LCD outputs at V_{DD} (display off)
- Bias generator off
- Power-on reset on, oscillator off (external clock still possible)
- V_{LCD} can be disconnected
- I²C-bus, RAM, commands, etc. still function in power-down mode.

Set Address

Table 3 Y0, Y1 and Y2 define the Y address vector address of the display RAM

Y2	Y1	Y0	LINE
0	0	0	0
0	0	1	1
0	1	0	2
0	1	1	3
1	0	0	4

Table 4 Instructions: control byte, address

INSTRUCTION	DB7	DB6	DB5	DB4	DB3	DB2	DB1	DB0	DESCRIPTION
Display control	0	E	D	PD	V	Y2	Y1	Y0	Y address vector, display control
X address	0	X address							set column address

Set X address

The X address points to the columns. The range of X is 0 to 100 (64H).

Reset function

After power-on the chip has the following state:

- Power-down mode (PD = 1)
- RAM undefined
- RAM X and Y address undefined
- Display control bits (except PD) undefined
- I²C-bus interface reset.

Note

If the chip is used with an external clock source, after power-on, the chip requires at least 2 clock pulses to ensure that an internal synchronous reset is carried out. After the internal reset, the chip goes into power-down mode (PD = 1). If the clock pulses are not supplied, and the reset is not cleared, the chip cannot respond to commands in the I²C bus.

In applications where the internal oscillator is used (pin OSC = V_{DD}), the oscillator starts after power-on. As soon as the synchronous reset is cleared, the chip goes into power-down mode, and the oscillator is stopped.

Universal LCD driver for small graphic panels

PCF8558

CHARACTERISTICS OF THE I²C-BUS

The I²C-bus is for bidirectional, two-line communication between different ICs or modules. The two lines are a serial data line (SDA) and a serial clock line (SCL) which must be connected to a positive supply via a pull-up resistor. Data transfer may be initiated only when the bus is not busy.

Bit transfer

One data bit is transferred during each clock pulse. The data on the SDA line must remain stable during the HIGH period of the clock pulse as changes in the data line at this moment will be interpreted as control signals.

START and STOP conditions

Both data and clock lines remain HIGH when the bus is not busy. A HIGH-to-LOW transition of the data line, while the clock is HIGH, is defined as the START condition (S). A LOW-to-HIGH transition of the data line while the clock is HIGH, is defined as the STOP condition (P).

System configuration

A device transmitting a message is a 'transmitter', a device receiving a message is the 'receiver'. The device that controls the message flow is the 'master' and the devices which are controlled by the master are the 'slaves'.

Acknowledge

The number of data bytes transferred between the START and STOP conditions from transmitter to receiver is unlimited. Each data byte of eight bits is followed by one acknowledge bit. The acknowledge bit is a HIGH level put on the bus by the transmitter, whereas the master generates an extra acknowledge related clock pulse. A slave receiver which is addressed must generate an acknowledge after the reception of each byte. Also a master must generate an acknowledge after the reception of each byte that has been clocked out of the slave transmitter. The device that acknowledges must pull down the SDA line during the acknowledge clock pulse, so that the SDA line is stable LOW during the HIGH period of the acknowledge related clock pulse (set-up and hold times must be taken into consideration). A master receiver must signal the end of a data transmission to the transmitter by **not** generating an acknowledge on the last byte that has been clocked out of the slave. In this event the transmitter must leave the data line HIGH to enable the master to generate a stop condition.

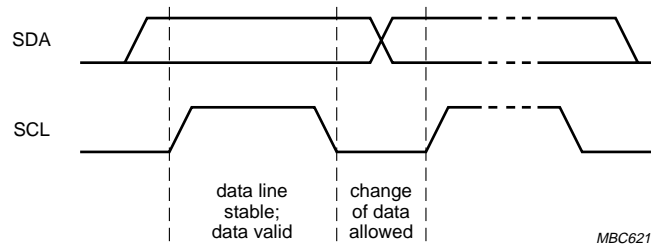

Fig.7 Bit transfer.

Universal LCD driver for small graphic panels

PCF8558

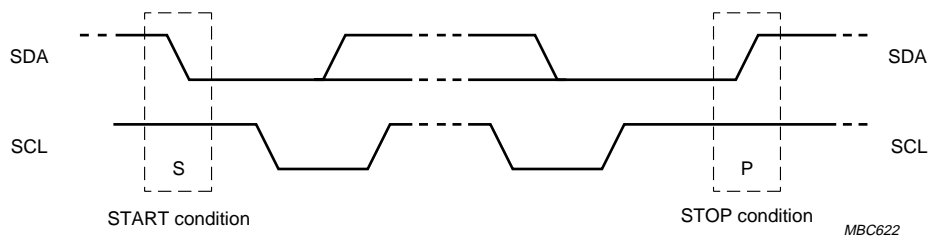

Fig.8 Definition of START and STOP condition.

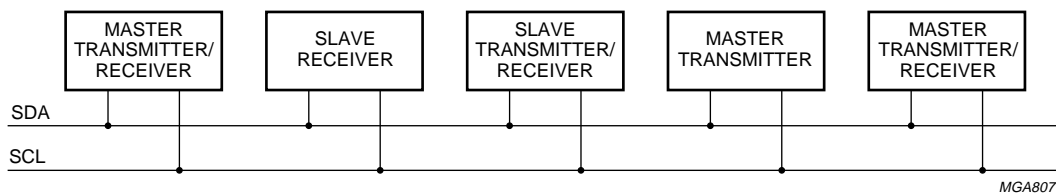
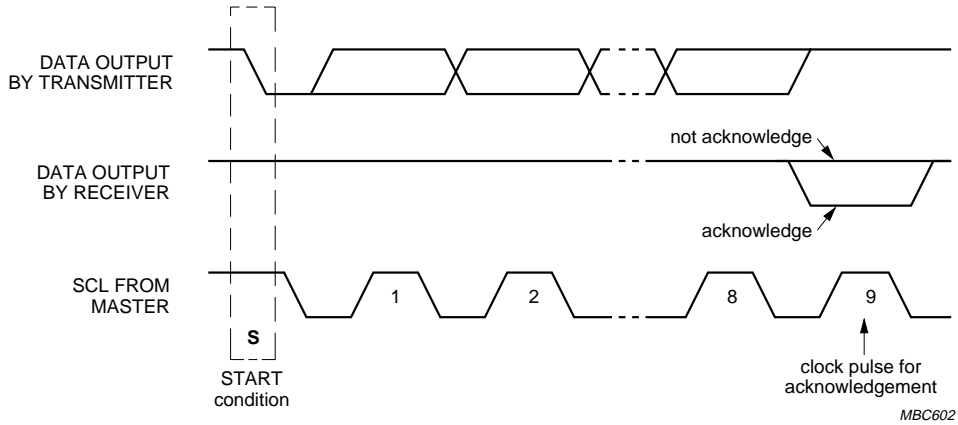

Fig.9 System configuration.

Universal LCD driver for small graphic panels

PCF8558



The general characteristics and detailed specification of the I²C-bus are available on request (order number 9398 393 40011).

Fig.10 Acknowledgment on the I²C-bus.

LIMITING VALUES

In accordance with the Absolute Maximum Rating System (IEC 134).

SYMBOL	PARAMETER	MIN.	MAX.	UNIT
V _{DD}	supply voltage	-0.5	+8.0	V
V _{LCD}	LCD supply voltage	V _{DD} - 11	V _{DD}	V
V _{i1}	input voltage T1, T3, SA0 and OSC	V _{SS} - 0.5	V _{DD} + 0.5	V
V _{i2}	input voltage SDA and SCL	V _{SS} - 0.5	8.0	V
V _{o1}	output voltage T2 and SDA	V _{SS} - 0.5	V _{DD} + 0.5	V
V _{o2}	output voltage R1 to R40 and C1 to C101	V _{LCD} - 0.5	V _{DD} + 0.5	V
I _I	DC input current	-10	+10	mA
I _O	DC output current	-10	+10	mA
I _{DD} , I _{SS} , I _{LCD}	V _{DD} , V _{SS} or V _{LCD} current	-50	+50	mA
P _{tot}	power dissipation per package	-	400	mW
P _o	power dissipation per output	-	100	mW
T _{stg}	storage temperature	-65	+150	°C

HANDLING

Inputs and outputs are protected against electrostatic discharge in normal handling. However, to be totally safe it is desirable to take normal precautions appropriate to handling MOS devices.

Universal LCD driver for small graphic panels

PCF8558

DC CHARACTERISTICS

$V_{DD} = 2.5$ to 6 V; $V_{SS} = 0$ V; $V_{LCD} = V_{DD} - 3.5$ V to $V_{DD} - 9$ V; $T_{amb} = -40$ to $+85$ °C; unless otherwise specified, note 1.

SYMBOL	PARAMETER	CONDITIONS	MIN.	TYP.	MAX.	UNIT
Supplies						
V_{DD}	supply voltage		2.5	–	6.0	V
V_{LCD}	LCD supply voltage		$V_{DD} - 9$	–	$V_{DD} - 3.5$	V
$I_{DD(PD)}$	supply current in power-down mode		–	5	10	μ A
I_{DD1}	supply current external clock		–	120	180	μ A
I_{DD2}	supply current internal clock		–	130	200	μ A
I_{LCD}	LCD input current		–	50	100	μ A
V_{POR}	power-on reset level	note 2	0.6	1.3	1.8	V
Logic						
V_{IL1}	LOW level input voltage (all inputs except OSC)		V_{SS}	–	$0.3V_{DD}$	V
V_{IH1}	HIGH level input voltage (all inputs except OSC)		$0.7V_{DD}$	–	V_{DD}	V
V_{IL2}	LOW level input voltage (pin OSC)		V_{SS}	–	$V_{DD} - 1.5$	V
V_{IH2}	HIGH level input voltage (pin OSC)		$V_{DD} - 0.1$	–	V_{DD}	V
I_{L1}	leakage current at T1, T3 OSC and SA0	$V_I = V_{DD}$ or V_{SS}	–1	–	+1	mA
C_{I1}	input capacitance at T1, T3 OSC and SA0	note 3	–	–	5	pF
LCD outputs						
V_{DC}	DC component of LCD drivers R1 to R40 and C1 to C101		–	± 20	–	mV
R_{ROW}	output resistance R1 to R40	note 4	–	1.5	6	k Ω
R_{COL}	output resistance C1 to C101	note 4	–	3	10	k Ω
I²C-bus; SDA and SCL						
V_{IL3}	LOW level input voltage	note 5	V_{SS}	–	$0.3V_{DD}$	V
V_{IH3}	HIGH level input voltage	note 5	$0.7V_{DD}$	–	6	V
I_{L2}	leakage current	$V_I = V_{DD}$ or V_{SS}	–1	–	+1	mA
C_{I2}	input capacitance	note 3	–	–	7	pF
I_{OL}	LOW level output current at SDA	$V_{OL} = 0.4$ V; $V_{DD} = 5$ V	3.0	–	–	mA

Notes

- Outputs are open-circuit; inputs at V_{DD} or V_{SS} ; I²C-bus inactive; external clock with 50% duty factor.
- Resets all logic when $V_{DD} < V_{POR}$.
- Periodically sampled, not 100% tested.
- Resistance of output terminals (R1 to R40 and C1 to C101) with $I_L = 20$ μ A; $V_{OP} = V_{DD} - V_{LCD} = 9$ V; outputs measured one at a time.
- When the voltages are above or below the supply voltages V_{DD} or V_{SS} , an input current may flow. This current must not exceed ± 0.5 mA.

Universal LCD driver for small graphic panels

PCF8558

AC CHARACTERISTICS

All timing values are referenced to V_{IH} and V_{IL} levels with an input voltage swing of V_{SS} to V_{DD} . $V_{DD} = 2.5$ to 6 V; $V_{SS} = 0$ V; $V_{LCD} = V_{DD} - 3.5$ V to $V_{DD} - 9$ V; $T_{amb} = -40$ to $+85$ °C; unless otherwise specified.

SYMBOL	PARAMETER	CONDITIONS	MIN.	TYP.	MAX.	UNIT
f_{FR}	LCD frame frequency (internal oscillator)		37	62.5	94	Hz
$f_{OSC(ext)}$	external clock frequency		90	150	225	kHz
t_{PLCD}	driver delays	$V_{DD} - V_{LCD} = 9$ V; with test loads	–	–	100	μ s
I²C-bus (see Fig.12)						
f_{SCL}	SCL clock frequency		–	–	400	kHz
t_{CLKL}	SCL LOW time		1.3	–	–	μ s
t_{CLKH}	SCL HIGH time		0.6	–	–	μ s
t_{BUF}	bus free time	between successive STOP and START conditions	1.3	–	–	μ s
t_r	SCL and SDA rise time	note 1	–	–	300	ns
t_f	SCL and SDA fall time	note 1	$20 + 0.1C_b$	–	300	ns
$t_{SU;STA}$	START condition set-up time	repeated start codes only	0.6	–	–	μ s
$t_{HD;STA}$	START condition hold time		0.6	–	–	μ s
$t_{SU;DAT}$	data set-up time		100	–	–	ns
$t_{HD;DAT}$	data hold time		0	–	–	ns
$t_{SU;STO}$	STOP condition set-up time		0.6	–	–	μ s
t_{SW}	tolerable spike width on bus	note 2	–	–	50	ns
C_b	capacitive load per bus line		–	–	400	pF

Notes

- The rise and fall times specified here refer to the driver device (i.e. not PCF8558) and are part of the general fast I²C-bus specification. However, when PCF8558 asserts an acknowledge on SDA, the fall time is given by parameter t_f . C_b = capacitive load per bus line.
- The device inputs SDA and SCL are filtered and will reject spikes on the bus lines of width $<t_{SW(max)}$.

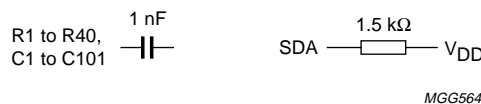

Fig.11 AC test loads.

Universal LCD driver for small graphic panels

PCF8558

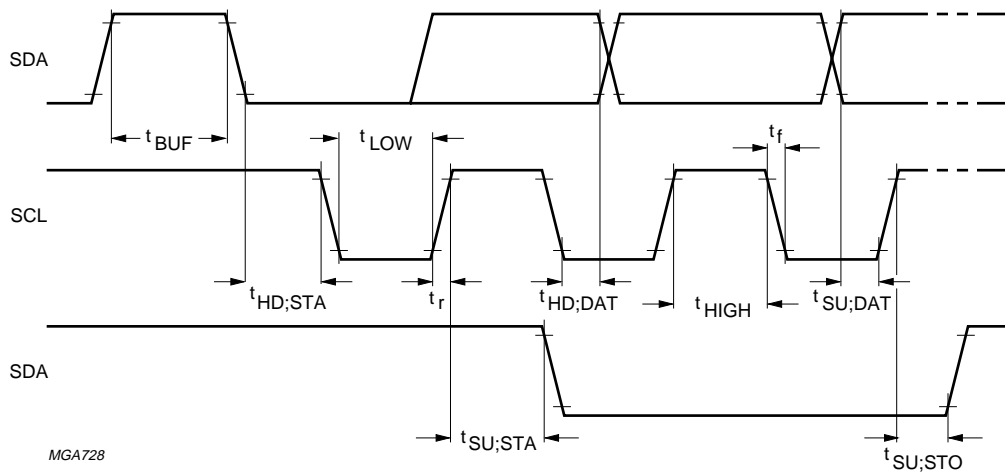

Fig.12 I²C-bus timing waveforms.

Universal LCD driver for small graphic panels

PCF8558

APPLICATION INFORMATION

The pinning of the PCF8558 is optimized for single plane wiring e.g. for Chip-on-glass display modules.

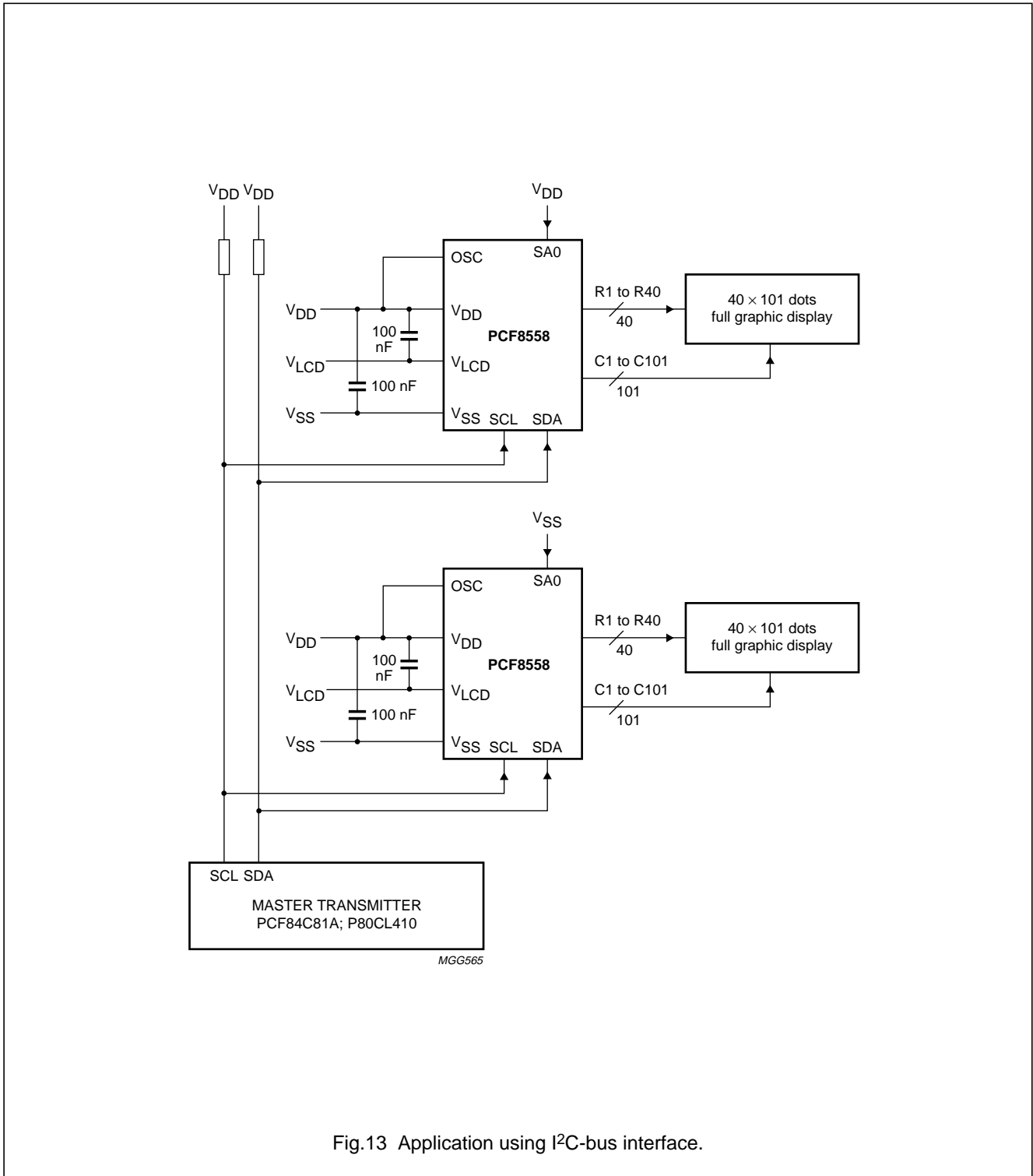
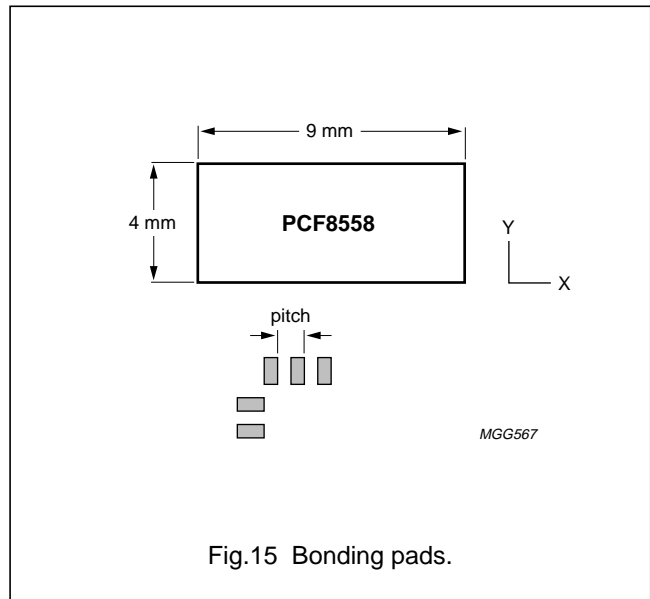
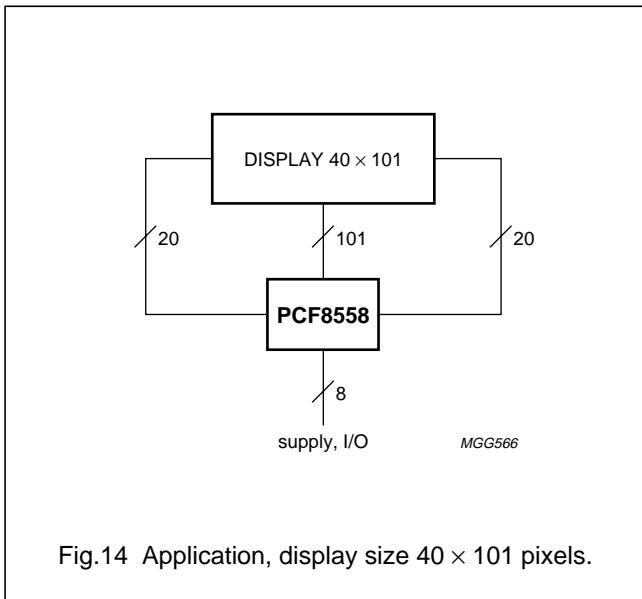

Fig.13 Application using I²C-bus interface.

Universal LCD driver for small graphic panels

PCF8558



CHIP INFORMATION

The PCF8558 is manufactured in p-well CMOS technology. $V_{DD} - V_{LCD}$ is positive. The chip substrate is connected to V_{DD} .

Bonding pads

Pad pitch	100	μm
Pad size, aluminium	80 × 120	μm
Bump dimensions	59 × 99 × 15	μm
Wafer thickness	381	μm

Universal LCD driver for small graphic panels

PCF8558

BONDING PAD LOCATIONS

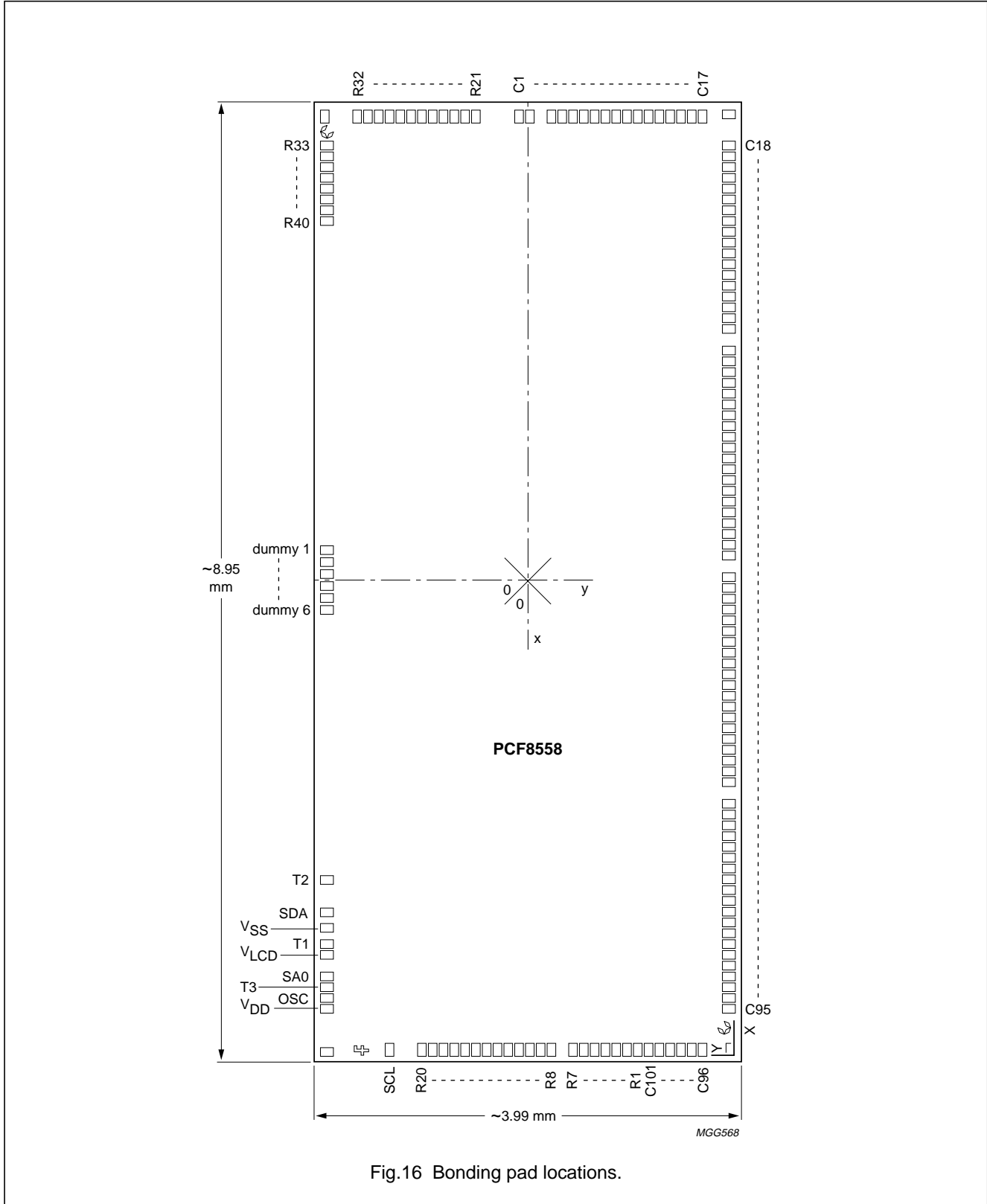

Fig.16 Bonding pad locations.

Universal LCD driver for small graphic panels

PCF8558

Table 5 Bonding pad locations (dimensions in μm).
All x/y coordinates are referenced to the centre of the chip, see Fig.16.

SYMBOL	PAD	x	y
SCL	1	-4303.6	1280.0
R20	2	-4303.6	1005.8
R19	3	-4303.6	905.8
R18	4	-4303.6	805.8
R17	5	-4303.6	705.8
R16	6	-4303.6	605.8
R15	7	-4303.6	505.8
R14	8	-4303.6	405.8
R13	9	-4303.6	305.8
R12	10	-4303.6	205.8
R11	11	-4303.6	105.8
R10	12	-4303.6	5.8
R9	13	-4303.6	-94.3
R8	14	-4303.6	-194.3
R7	15	-4303.6	-383.3
R6	16	-4303.6	-483.3
R5	17	-4303.6	-583.3
R4	18	-4303.6	-683.3
R3	19	-4303.6	-783.3
R2	20	-4303.6	-883.3
R1	21	-4303.6	-983.3
C101	22	-4303.6	-1083.3
C100	23	-4303.6	-1183.3
C99	24	-4303.6	-1283.3
C98	25	-4303.6	-1383.3
C97	26	-4303.6	-1483.3
C96	27	-4303.6	-1583.3
C95	28	-3903.6	-1823.5
C94	29	-3803.6	-1823.5
C93	30	-3703.6	-1823.5
C92	31	-3603.6	-1823.5
C91	32	-3503.6	-1823.5
C90	33	-3403.6	-1823.5
C89	34	-3303.6	-1823.5
C88	35	-3203.6	-1823.5
C87	36	-3103.6	-1823.5
C86	37	-3003.6	-1823.5
C85	38	-2903.6	-1823.5
C84	39	-2803.6	-1823.5
C83	40	-2703.6	-1823.5
C82	41	-2603.6	-1823.5

SYMBOL	PAD	x	y
C81	42	-2503.6	-1823.5
C80	43	-2403.6	-1823.5
C79	44	-2303.6	-1823.5
C78	45	-2203.6	-1823.5
C77	46	-2103.6	-1823.5
C76	47	-2003.6	-1823.5
C75	48	-1814.6	-1823.5
C74	49	-1714.6	-1823.5
C73	50	-1614.6	-1823.5
C72	51	-1514.6	-1823.5
C71	52	-1414.6	-1823.5
C70	53	-1314.6	-1823.5
C69	54	-1214.6	-1823.5
C68	55	-1114.6	-1823.5
C67	56	-1014.6	-1823.5
C66	57	-914.6	-1823.5
C65	58	-814.6	-1823.5
C64	59	-714.6	-1823.5
C63	60	-614.6	-1823.5
C62	61	-514.6	-1823.5
C61	62	-414.6	-1823.5
C60	63	-314.6	-1823.5
C59	64	-214.6	-1823.5
C58	65	-114.6	-1823.5
C57	66	-14.6	-1823.5
C56	67	85.4	-1823.5
C55	68	274.4	-1823.5
C54	69	374.4	-1823.5
C53	70	474.4	-1823.5
C52	71	574.4	-1823.5
C51	72	674.4	-1823.5
C50	73	774.4	-1823.5
C49	74	874.4	-1823.5
C48	75	974.4	-1823.5
C47	76	1074.4	-1823.5
C46	77	1174.4	-1823.5
C45	78	1274.4	-1823.5
C44	79	1374.4	-1823.5
C43	80	1474.4	-1823.5
C42	81	1574.4	-1823.5
C41	82	1674.4	-1823.5

Universal LCD driver for small graphic panels

PCF8558

SYMBOL	PAD	x	y
C40	83	1774.4	-1823.5
C39	84	1874.4	-1823.5
C38	85	1974.4	-1823.5
C37	86	2074.4	-1823.5
C36	87	2174.4	-1823.5
C35	88	2363.4	-1823.5
C34	89	2463.4	-1823.5
C33	90	2563.4	-1823.5
C32	91	2663.4	-1823.5
C31	92	2763.4	-1823.5
C30	93	2863.4	-1823.5
C29	94	2963.4	-1823.5
C28	95	3063.4	-1823.5
C27	96	3163.4	-1823.5
C26	97	3263.4	-1823.5
C25	98	3363.4	-1823.5
C24	99	3463.4	-1823.5
C23	100	3563.4	-1823.5
C22	101	3663.4	-1823.5
C21	102	3763.4	-1823.5
C20	103	3863.4	-1823.5
C19	104	3963.4	-1823.5
C18	105	4063.4	-1823.5
C17	106	4303.6	-1583
C16	107	4303.6	-1483
C15	108	4303.6	-1383
C14	109	4303.6	-1283
C13	110	4303.6	-1183
C12	111	4303.6	-1083
C11	112	4303.6	-983
C10	113	4303.6	-883
C9	114	4303.6	-783
C8	115	4303.6	-683
C7	116	4303.6	-583
C6	117	4303.6	-483
C5	118	4303.6	-383
C4	119	4303.6	-283
C3	120	4303.6	-183
C2	121	4303.6	5.8
C1	122	4303.6	105.8
R21	123	4303.6	483
R22	124	4303.6	583
R23	125	4303.6	683
R24	126	4303.6	783

SYMBOL	PAD	x	y
R25	127	4303.6	883
R26	128	4303.6	983
R27	129	4303.6	1083
R28	130	4303.6	1183
R29	131	4303.6	1283
R30	132	4303.6	1383
R31	133	4303.6	1483
R32	134	4303.6	1583
R33	135	4017.1	1823.5
R34	136	3917.1	1823.5
R35	137	3817.1	1823.5
R36	138	3717.1	1823.5
R37	139	3617.1	1823.5
R38	140	3517.1	1823.5
R39	141	3417.1	1823.5
R40	142	3317.1	1823.5
T2	143	-2695.6	1823.5
SDA	144	-3044.1	1823.5
V _{SS}	145	-3190.6	1823.5
T1	146	-3362.1	1823.5
V _{LCD}	147	-3463.6	1823.5
SA0	148	-3635.1	1823.5
T3	149	-3735.1	1823.5
OSC	150	-3839.1	1823.5
V _{DD}	151	-3939.6	1823.5
Dummy pads			
dummy 1	-	-257.1	1790.4
dummy 2	-	-155.6	1790.4
dummy 3	-	-54.1	1790.4
dummy 4	-	47.4	1790.4
dummy 5	-	148.9	1790.4
dummy 6	-	250.4	1790.4
dummy 7	-	-4223.6	1823.4
dummy 8	-	4303.5	1843.5
dummy 9	-	-4303.6	-1843.5
dummy 10	-	4323.6	-1843.5
Alignment marks			
Sign C	-	-4082.6	-1782.5
Sign C	-	4147.4	1807.5
Sign F	-	-4262.6	1417.5

Universal LCD driver for small graphic panels

PCF8558

DEFINITIONS

Data sheet status	
Objective specification	This data sheet contains target or goal specifications for product development.
Preliminary specification	This data sheet contains preliminary data; supplementary data may be published later.
Product specification	This data sheet contains final product specifications.
Limiting values	
Limiting values given are in accordance with the Absolute Maximum Rating System (IEC 134). Stress above one or more of the limiting values may cause permanent damage to the device. These are stress ratings only and operation of the device at these or at any other conditions above those given in the Characteristics sections of the specification is not implied. Exposure to limiting values for extended periods may affect device reliability.	
Application information	
Where application information is given, it is advisory and does not form part of the specification.	

LIFE SUPPORT APPLICATIONS

These products are not designed for use in life support appliances, devices, or systems where malfunction of these products can reasonably be expected to result in personal injury. Philips customers using or selling these products for use in such applications do so at their own risk and agree to fully indemnify Philips for any damages resulting from such improper use or sale.

PURCHASE OF PHILIPS I²C COMPONENTS



Purchase of Philips I²C components conveys a license under the Philips' I²C patent to use the components in the I²C system provided the system conforms to the I²C specification defined by Philips. This specification can be ordered using the code 9398 393 40011.

Universal LCD driver for small graphic
panels

PCF8558

NOTES

Philips Semiconductors – a worldwide company

Argentina: see South America

Australia: 34 Waterloo Road, NORTH RYDE, NSW 2113,
Tel. +61 2 9805 4455, Fax. +61 2 9805 4466

Austria: Computerstr. 6, A-1101 WIEN, P.O. Box 213, Tel. +43 160 1010,
Fax. +43 160 101 1210

Belarus: Hotel Minsk Business Center, Bld. 3, r. 1211, Volodarski Str. 6,
220050 MINSK, Tel. +375 172 200 733, Fax. +375 172 200 773

Belgium: see The Netherlands

Brazil: see South America

Bulgaria: Philips Bulgaria Ltd., Energoproject, 15th floor,
51 James Bourchier Blvd., 1407 SOFIA,
Tel. +359 2 689 211, Fax. +359 2 689 102

Canada: PHILIPS SEMICONDUCTORS/COMPONENTS,
Tel. +1 800 234 7381

China/Hong Kong: 501 Hong Kong Industrial Technology Centre,
72 Tat Chee Avenue, Kowloon Tong, HONG KONG,
Tel. +852 2319 7888, Fax. +852 2319 7700

Colombia: see South America

Czech Republic: see Austria

Denmark: Prags Boulevard 80, PB 1919, DK-2300 COPENHAGEN S,
Tel. +45 32 88 2636, Fax. +45 31 57 0044

Finland: Sinikalliontie 3, FIN-02630 ESPOO,
Tel. +358 9 615800, Fax. +358 9 61580920

France: 51 Rue Carnot, BP317, 92156 SURESNES Cedex,
Tel. +33 1 40 99 6161, Fax. +33 1 40 99 6427

Germany: Hammerbrookstraße 69, D-20097 HAMBURG,
Tel. +49 40 23 53 60, Fax. +49 40 23 536 300

Greece: No. 15, 25th March Street, GR 17778 TAVROS/ATHENS,
Tel. +30 1 4894 339/239, Fax. +30 1 4814 240

Hungary: see Austria

India: Philips INDIA Ltd, Band Box Building, 2nd floor,
254-D, Dr. Annie Besant Road, Worli, MUMBAI 400 025,
Tel. +91 22 493 8541, Fax. +91 22 493 0966

Indonesia: PT Philips Development Corporation, Semiconductors Division,
Gedung Philips, Jl. Buncit Raya Kav.99-100, JAKARTA 12510,
Tel. +62 21 794 0040 ext. 2501, Fax. +62 21 794 0080

Ireland: Newstead, Clonskeagh, DUBLIN 14,
Tel. +353 1 7640 000, Fax. +353 1 7640 200

Israel: RAPAC Electronics, 7 Kehilat Saloniki St, PO Box 18053,
TEL AVIV 61180, Tel. +972 3 645 0444, Fax. +972 3 649 1007

Italy: PHILIPS SEMICONDUCTORS, Piazza IV Novembre 3,
20124 MILANO, Tel. +39 2 6752 2531, Fax. +39 2 6752 2557

Japan: Philips Bldg 13-37, Kohnan 2-chome, Minato-ku, TOKYO 108,
Tel. +81 3 3740 5130, Fax. +81 3 3740 5077

Korea: Philips House, 260-199 Itaewon-dong, Yongsan-ku, SEOUL,
Tel. +82 2 709 1412, Fax. +82 2 709 1415

Malaysia: No. 76 Jalan Universiti, 46200 PETALING JAYA, SELANGOR,
Tel. +60 3 750 5214, Fax. +60 3 757 4880

Mexico: 5900 Gateway East, Suite 200, EL PASO, TEXAS 79905,
Tel. +9-5 800 234 7381

Middle East: see Italy

Netherlands: Postbus 90050, 5600 PB EINDHOVEN, Bldg. VB,
Tel. +31 40 27 82785, Fax. +31 40 27 88399

New Zealand: 2 Wagener Place, C.P.O. Box 1041, AUCKLAND,
Tel. +64 9 849 4160, Fax. +64 9 849 7811

Norway: Box 1, Manglerud 0612, OSLO,
Tel. +47 22 74 8000, Fax. +47 22 74 8341

Pakistan: see Singapore

Philippines: Philips Semiconductors Philippines Inc.,
106 Valero St. Salcedo Village, P.O. Box 2108 MCC, MAKATI,
Metro MANILA, Tel. +63 2 816 6380, Fax. +63 2 817 3474

Poland: Ul. Lukiska 10, PL 04-123 WARSZAWA,
Tel. +48 22 612 2831, Fax. +48 22 612 2327

Portugal: see Spain

Romania: see Italy

Russia: Philips Russia, Ul. Usatcheva 35A, 119048 MOSCOW,
Tel. +7 095 755 6918, Fax. +7 095 755 6919

Singapore: Lorong 1, Toa Payoh, SINGAPORE 319762,
Tel. +65 350 2538, Fax. +65 251 6500

Slovakia: see Austria

Slovenia: see Italy

South Africa: S.A. PHILIPS Pty Ltd., 195-215 Main Road Martindale,
2092 JOHANNESBURG, P.O. Box 7430 Johannesburg 2000,
Tel. +27 11 470 5911, Fax. +27 11 470 5494

South America: Al. Vicente Pinzon, 173, 6th floor,
04547-130 SÃO PAULO, SP, Brazil,
Tel. +55 11 821 2333, Fax. +55 11 821 2382

Spain: Balmes 22, 08007 BARCELONA,
Tel. +34 3 301 6312, Fax. +34 3 301 4107

Sweden: Kottbygatan 7, Akalla, S-16485 STOCKHOLM,
Tel. +46 8 5985 2000, Fax. +46 8 5985 2745

Switzerland: Allmendstrasse 140, CH-8027 ZÜRICH,
Tel. +41 1 488 2741 Fax. +41 1 488 3263

Taiwan: Philips Semiconductors, 6F, No. 96, Chien Kuo N. Rd., Sec. 1,
TAIPEI, Taiwan Tel. +886 2 2134 2865, Fax. +886 2 2134 2874

Thailand: PHILIPS ELECTRONICS (THAILAND) Ltd.,
209/2 Sanpavuth-Bangna Road Prakanong, BANGKOK 10260,
Tel. +66 2 745 4090, Fax. +66 2 398 0793

Turkey: Talatpasa Cad. No. 5, 80640 GÜLTEPE/ISTANBUL,
Tel. +90 212 279 2770, Fax. +90 212 282 6707

Ukraine: PHILIPS UKRAINE, 4 Patrice Lumumba str., Building B, Floor 7,
252042 KIEV, Tel. +380 44 264 2776, Fax. +380 44 268 0461

United Kingdom: Philips Semiconductors Ltd., 276 Bath Road, Hayes,
MIDDLESEX UB3 5BX, Tel. +44 181 730 5000, Fax. +44 181 754 8421

United States: 811 East Arques Avenue, SUNNYVALE, CA 94088-3409,
Tel. +1 800 234 7381

Uruguay: see South America

Vietnam: see Singapore

Yugoslavia: PHILIPS, Trg N. Pasica 5/v, 11000 BEOGRAD,
Tel. +381 11 625 344, Fax. +381 11 635 777

For all other countries apply to: Philips Semiconductors,
International Marketing & Sales Communications, Building BE-p, P.O. Box 218,
5600 MD EINDHOVEN, The Netherlands, Fax. +31 40 27 24825

Internet: <http://www.semiconductors.philips.com>

© Philips Electronics N.V. 1998

SCA59

All rights are reserved. Reproduction in whole or in part is prohibited without the prior written consent of the copyright owner.

The information presented in this document does not form part of any quotation or contract, is believed to be accurate and reliable and may be changed without notice. No liability will be accepted by the publisher for any consequence of its use. Publication thereof does not convey nor imply any license under patent- or other industrial or intellectual property rights.

Printed in The Netherlands

415106/1200/02/pp24

Date of release: 1998 Apr 07

Document order number: 9397 750 03284

Let's make things better.

**Philips
Semiconductors**



PHILIPS