

DATA SHEET

TDA8765

**10-bit high-speed Analog-to-Digital
Converter (ADC)**

Preliminary specification
Supersedes data of 1998 May 08
File under Integrated Circuits, IC02

1999 Jan 06

10-bit high-speed Analog-to-Digital Converter (ADC)

TDA8765

FEATURES

- 10-bit resolution
- Sampling rate up to 55 MHz
- -3 dB bandwidth of 200 MHz
- 5 V power supplies
- Binary or twos-complement CMOS outputs
- In-range CMOS-compatible output
- TTL- CMOS-compatible static digital inputs
- 3 to 5 V CMOS-compatible digital outputs
- Differential clock input; Positive Emitter Coupled Logic (PECL) compatible
- Power dissipation 325 mW (typical)
- Low analog input capacitance (typical 2 pF), no buffer amplifier required
- Integrated sample-and-hold amplifier
- Differential analog input
- External amplitude range control
- Voltage controlled regulator included.

APPLICATIONS

- High-speed analog-to-digital conversion for
 - Video signal digitizing
 - High Definition TV (HDTV)
 - Imaging (camera scanner)
 - Medical imaging
 - Telecommunication
 - Base-station receiver.

GENERAL DESCRIPTION

The TDA8765 is a bipolar 10-bit Analog-to-Digital Converter (ADC) optimized for telecommunications and professional imaging. It converts the analog input signal into 10-bit binary coded digital words at a maximum sampling rate of 55 MHz. All static digital inputs (SH, $\overline{\text{CE}}$ and OTC) are TTL and CMOS compatible and all outputs are CMOS compatible. A sine wave clock input signal can also be used.

QUICK REFERENCE DATA

SYMBOL	PARAMETER	CONDITIONS	MIN.	TYP.	MAX.	UNIT
V_{CCA}	analog supply voltage		4.75	5.0	5.25	V
V_{CCD}	digital supply voltage		4.75	5.0	5.25	V
V_{CCO}	output supply voltage		3.0	3.3	5.25	V
I_{CCA}	analog supply current		–	33	tbf	mA
I_{CCD}	digital supply current		–	30	tbf	mA
I_{CCO}	output supply current	$f_{\text{CLK}} = 4 \text{ MHz}; f_i = 400 \text{ kHz}$	–	3.2	tbf	mA
INL	integral non-linearity	$f_{\text{CLK}} = 4 \text{ MHz}; f_i = 400 \text{ kHz}$	–	± 0.5	± 1.75	LSB
DNL	differential non-linearity	$f_{\text{CLK}} = 4 \text{ MHz}; f_i = 400 \text{ kHz}$	–	± 0.3	± 0.5	LSB
$f_{\text{CLK(max)}}$	maximum clock frequency					
	TDA8765H/4		40	–	–	MHz
	TDA8765H/5		55	–	–	MHz
P_{tot}	total power dissipation		–	325	tbf	mW

ORDERING INFORMATION

TYPE NUMBER	PACKAGE			SAMPLING FREQUENCY (MHz)
	NAME	DESCRIPTION	VERSION	
TDA8765H/4	QFP44	plastic quad flat package; 44 leads (lead length 1.3 mm); body 10 × 10 × 1.75 mm	SOT307-2	40
TDA8765H/5				55

10-bit high-speed Analog-to-Digital Converter (ADC)

TDA8765

BLOCK DIAGRAM

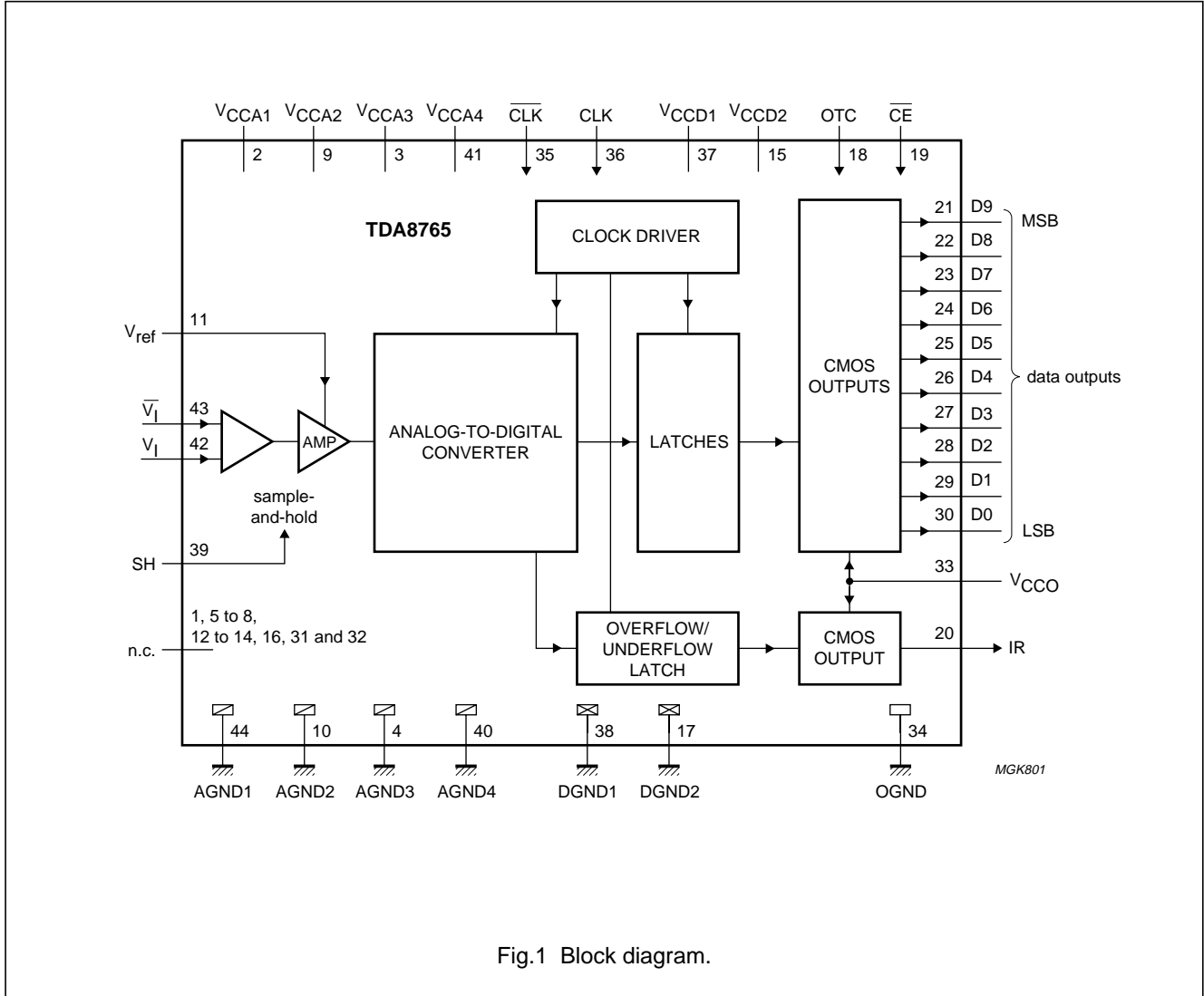

Fig.1 Block diagram.

10-bit high-speed Analog-to-Digital Converter (ADC)

TDA8765

PINNING

SYMBOL	PIN	DESCRIPTION
n.c.	1	not connected
V _{CCA1}	2	analog supply voltage 1 (+5 V)
V _{CCA3}	3	analog supply voltage 3 (+5 V)
AGND3	4	analog ground 3
n.c.	5	not connected
n.c.	6	not connected
n.c.	7	not connected
n.c.	8	not connected
V _{CCA2}	9	analog supply voltage 2 (+5 V)
AGND2	10	analog ground 2
V _{ref}	11	reference voltage input
n.c.	12	not connected
n.c.	13	not connected
n.c.	14	not connected
V _{CCD2}	15	digital supply voltage 2 (+5 V)
n.c.	16	not connected
DGND2	17	digital ground 2
OTC	18	control input twos complement output; active HIGH
$\overline{\text{CE}}$	19	chip enable input (CMOS level; active LOW)
IR	20	in-range output
D9	21	data output; bit 9 (MSB)
D8	22	data output; bit 8

SYMBOL	PIN	DESCRIPTION
D7	23	data output; bit 7
D6	24	data output; bit 6
D5	25	data output; bit 5
D4	26	data output; bit 4
D3	27	data output; bit 3
D2	28	data output; bit 2
D1	29	data output; bit 1
D0	30	data output; bit 0 (LSB)
n.c.	31	not connected
n.c.	32	not connected
V _{CCO}	33	output supply voltage (3 to 5.25 V)
OGND	34	output ground
$\overline{\text{CLK}}$	35	complementary clock input; active LOW
CLK	36	clock input
V _{CCD1}	37	digital supply voltage 1 (+5 V)
DGND1	38	digital ground 1
SH	39	sample-and-hold enable input (CMOS level; active HIGH)
AGND4	40	analog ground 4
V _{CCA4}	41	analog supply voltage 4 (+5 V)
V _I	42	positive analog input voltage
$\overline{\text{V}}_I$	43	negative analog input voltage
AGND1	44	analog ground 1

10-bit high-speed Analog-to-Digital Converter (ADC)

TDA8765

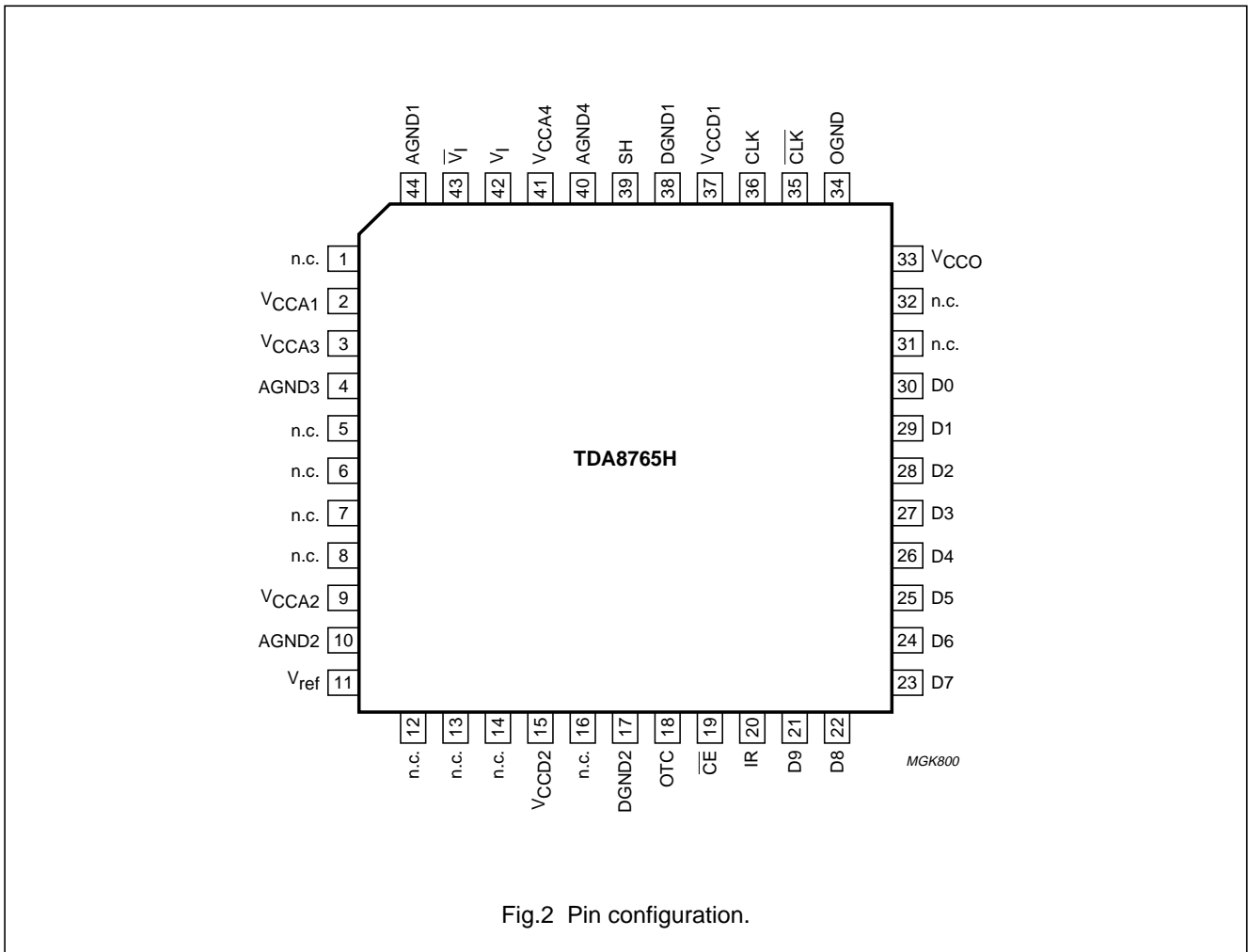

Fig.2 Pin configuration.

10-bit high-speed Analog-to-Digital Converter (ADC)

TDA8765

LIMITING VALUES

In accordance with the Absolute Maximum Rating System (IEC 134).

SYMBOL	PARAMETER	CONDITIONS	MIN.	MAX.	UNIT
V_{CCA}	analog supply voltage	note 1	-0.3	+7.0	V
V_{CCD}	digital supply voltage	note 1	-0.3	+7.0	V
V_{CCO}	output supply voltage	note 1	-0.3	+7.0	V
ΔV_{CC}	supply voltage difference				
	$V_{CCA} - V_{CCD}$		-1.0	+1.0	V
	$V_{CCD} - V_{CCO}$		-1.0	+4.0	V
	$V_{CCA} - V_{CCO}$		-1.0	+4.0	V
V_I	input voltage at pins 42 and 43	referenced to AGND	0.3	V_{CCA}	V
$V_{i(p-p)}$	input voltage at pins 35 and 36 for differential clock drive (peak-to-peak value)		-	V_{CCD}	V
I_O	output current		-	10	mA
T_{stg}	storage temperature		-55	+150	°C
T_{amb}	operating ambient temperature		0	+85	°C
T_j	junction temperature		-	150	°C

Note

- The supply voltages V_{CCA} , V_{CCD} and V_{CCO} may have any value between -0.3 and +7.0 V provided that the supply voltage differences ΔV_{CC} are respected.

HANDLING

Inputs and outputs are protected against electrostatic discharges in normal handling. However, to be totally safe, it is desirable to take normal precautions appropriate to handling integrated circuits.

THERMAL CHARACTERISTICS

SYMBOL	PARAMETER	CONDITION	VALUE	UNIT
$R_{th(j-a)}$	thermal resistance from junction to ambient	in free air	75	K/W

10-bit high-speed Analog-to-Digital Converter (ADC)

TDA8765

CHARACTERISTICS

$V_{CCA} = V_2$ to V_{44} , V_9 to V_{10} , V_3 to V_4 and V_{41} to $V_{40} = 4.75$ to 5.25 V; $V_{CCD} = V_{37}$ to V_{38} and V_{15} to $V_{17} = 4.75$ to 5.25 V; $V_{CCO} = V_{33}$ to $V_{34} = 3.0$ to 5.25 V; AGND and DGND shorted together; $T_{amb} = 0$ to 85 °C; typical values measured at $V_{CCA} = V_{CCD} = 5$ V and $V_{CCO} = 3.3$ V, $T_{amb} = 25$ °C, $V_{I(p-p)} - \bar{V}_{I(p-p)} = 2.0$ V and $C_L = 10$ pF; unless otherwise specified.

SYMBOL	PARAMETER	CONDITIONS	MIN.	TYP.	MAX.	UNIT
Supply						
V_{CCA}	analog supply voltage		4.75	5.0	5.25	V
V_{CCD}	digital supply voltage		4.75	5.0	5.25	V
V_{CCO}	output supply voltage		3.0	3.3	5.25	V
I_{CCA}	analog supply current		–	33	45	mA
I_{CCD}	digital supply current		–	30	37	mA
I_{CCO}	output supply current	$f_{CLK} = 4$ MHz; $f_i = 400$ kHz	–	3.2	tbf	mA
		$f_{CLK} = 40$ MHz; $f_i = 4.43$ MHz	–	11	tbf	mA
Inputs						
CLK AND \overline{CLK} (REFERENCED TO DGND)						
V_{IL}	LOW-level input voltage	$V_{CCD} = 5$ V; note 1	3.19	–	3.52	V
V_{IH}	HIGH-level input voltage	$V_{CCD} = 5$ V; note 1	3.83	–	4.12	V
I_{IL}	LOW-level input current	V_{CLK} or $V_{\overline{CLK}} = 3.19$ V	–10	–	–	μ A
I_{IH}	HIGH-level input current	V_{CLK} or $V_{\overline{CLK}} = 3.83$ V	–	–	10	μ A
Z_i	input impedance	$f_{CLK} = 40$ MHz	2	–	–	k Ω
C_i	input capacitance	$f_{CLK} = 40$ MHz	–	–	2	pF
$\Delta V_{CLK(p-p)}$	differential AC input voltage for switching ($V_{CLK} - V_{\overline{CLK}}$; peak-to-peak value)	DC voltage level = 2.5 V	0.5	–	2.0	V
OTC, SH AND \overline{CE} (REFERENCED TO DGND); see Tables 2 and 3						
V_{IL}	LOW-level input voltage		0	–	0.8	V
V_{IH}	HIGH-level input voltage		2.0	–	V_{CCD}	V
I_{IL}	LOW-level input current	$V_{IL} = 0.8$ V	–20	–	–	μ A
I_{IH}	HIGH-level input current	$V_{IH} = 2.0$ V	–	–	20	μ A
V_I AND \bar{V}_I (REFERENCED TO AGND; see Table 1); $V_{REF} = V_{CCA} - 1.825$ V						
I_{IL}	LOW-level input current		–	10	–	μ A
I_{IH}	HIGH-level input current		–	10	–	μ A
R_i	input resistance	$f_i = 4.43$ MHz	100	–	–	k Ω
C_i	input capacitance	$f_i = 4.43$ MHz	–	–	2	pF
$V_{I(CM)}$	common mode input voltage	$V_I = \bar{V}_I$; output code 511				
		$V_{CCA} = 5$ V	tbf	3.6	tbf	V
		$V_{CCA} = 4.75$ V	tbf	3.35	tbf	V
		$V_{CCA} = 5.25$ V	tbf	3.85	tbf	V

10-bit high-speed Analog-to-Digital Converter (ADC)

TDA8765

SYMBOL	PARAMETER	CONDITIONS	MIN.	TYP.	MAX.	UNIT
Voltage controlled regulator input V_{ref} (referenced to AGND); note 2						
V_{ref}	full-scale fixed voltage	$V_{CCA} = 5\text{ V}$	–	3.175	–	V
$V_{I(p-p)} - \bar{V}_{I(p-p)}$	input voltage amplitude (peak-to-peak value)	$V_{ref} = V_{CCA} - 1.825\text{ V}$	–	2.0	–	V
I_{ref}	input current at V_{ref}		–	0.5	10	μA
Outputs (referenced to OGND)						
DIGITAL OUTPUTS D11 TO D0 AND IR (REFERENCED TO OGND)						
V_{OL}	LOW-level output voltage	$I_{OL} = 2\text{ mA}$	0	–	0.5	V
V_{OH}	HIGH-level output voltage	$I_{OH} = -0.4\text{ mA}$	$V_{CCO} - 0.5$	–	V_{CCO}	V
I_o	output current in 3-state	output level between 0.5 V and V_{CCO}	–20	–	+20	μA
Switching characteristics						
CLOCK FREQUENCY f_{CLK} ; see Fig.5						
$f_{CLK(min)}$	minimum clock frequency	SH = HIGH	–	–	1	MHz
		SH = LOW	–	–	1	kHz
$f_{CLK(max)}$	maximum clock frequency TDA8765H/4 TDA8765H/5		40	–	–	MHz
			55	–	–	MHz
t_{CLKH}	clock pulse width HIGH		8.5	–	–	ns
t_{CLKL}	clock pulse width LOW		8.5	–	–	ns
Analog signal processing; 50% clock duty factor; $V_I - \bar{V}_I = 2.0\text{ V}$; $V_{ref} = V_{CCA} - 1.825\text{ V}$; see Table 1						
LINEARITY						
INL	integral non-linearity	$f_{CLK} = 4\text{ MHz}$; $f_i = 400\text{ kHz}$	–	± 0.5	± 1.75	LSB
DNL	differential non-linearity	$f_{CLK} = 4\text{ MHz}$; $f_i = 400\text{ kHz}$; no missing code	–	± 0.3	± 0.5	LSB
E_{offset}	offset error	$V_{CCA} = V_{CCD} = V_{CCO} = 5\text{ V}$; $T_{amb} = 25\text{ }^\circ\text{C}$; $V_I = \bar{V}_I$; output code = 511	tbf	–11	tbf	mV
E_G	gain error amplitude; spread from device to device	$V_{CCA} = V_{CCD} = V_{CCO} = 5\text{ V}$; $T_{amb} = 25\text{ }^\circ\text{C}$; $V_{I(p-p)} - \bar{V}_{I(p-p)} = 2.0\text{ V}$	–5	–	+5	%FS
BANDWIDTH ($f_{CLK} = 55\text{ MHz}$); note 3						
B	analog bandwidth	–3 dB; full-scale input	tbf	200	–	MHz

10-bit high-speed Analog-to-Digital Converter (ADC)

TDA8765

SYMBOL	PARAMETER	CONDITIONS	MIN.	TYP.	MAX.	UNIT
HARMONICS ($f_{CLK} = 40$ MHz)						
$H_{fund(FS)}$	fundamental harmonics (full scale)	$f_i = 4.43$ MHz	–	–	0	dB
$H_{tot(FS)}$	harmonics (full scale); all components	$f_i = 4.43$ MHz				
	second harmonic		–	–75	–	dB
	third harmonic		–	–70	–	dB
THD	total harmonic distortion	$f_i = 4.43$ MHz; note 4	–	–66	–	dB
THERMAL NOISE						
$N_{th(rms)}$	thermal noise (RMS value)	grounded input; $f_{CLK} = 40$ MHz	–	0.2	tbf	LSB
SPURIOUS FREE DYNAMIC RANGE						
DR_{sf}	spurious free dynamic range	$f_i = 4.43$ MHz	tbf	71	–	dB
		$f_i = 10$ MHz	tbf	68	–	dB
		$f_i = 20$ MHz	tbf	67	–	dB
SIGNAL-TO-NOISE RATIO; note 5						
S/N	signal-to-noise ratio	without harmonics; $f_{CLK} = 40$ MHz; $f_i = 4.43$ MHz	–	59	–	dB
EFFECTIVE NUMBER OF BITS; see Figs 3 and 4 and note 5						
N_{bit}	effective number of bits TDA8765H/4 ($f_{CLK} = 40$ MHz)	$f_i = 4.43$ MHz	9.0	9.6	–	bits
		$f_i = 10$ MHz	–	9.6	–	bits
		$f_i = 15$ MHz	–	9.5	–	bits
	effective number of bits TDA8765H/5 ($f_{CLK} = 55$ MHz)	$f_i = 4.43$ MHz	–	9.6	–	bits
		$f_i = 10$ MHz	–	9.4	–	bits
		$f_i = 15$ MHz	–	9.3	–	bits
		$f_i = 20$ MHz	–	9.1	–	bits
INTERMODULATION; note 6						
TTIR	two-tone intermodulation rejection	$f_{CLK} = 40$ MHz	tbf	66	–	dB
d_3	third-order intermodulation distortion	$f_{CLK} = 40$ MHz	tbf	67	–	dB
BIT ERROR RATE						
BER	bit error rate	$f_{CLK} = 40$ MHz; $f_i = 4.43$ MHz; $V_1 = \pm 16$ LSB at code 511	–	10^{-15}	tbf	times/sample

10-bit high-speed Analog-to-Digital Converter (ADC)

TDA8765

SYMBOL	PARAMETER	CONDITIONS	MIN.	TYP.	MAX.	UNIT
Timing ($C_L = 10$ pF); see Fig.5 and note 7						
$t_{d(s)}$	sampling delay time		–	–	2	ns
t_h	output hold time		4	–	–	ns
t_d	output delay time	$V_{CCO} = 5.25$ V	–	10	15	ns
		$V_{CCO} = 3.0$ V	–	13	18	ns
3-state output delay times; see Fig.6						
t_{dZH}	enable HIGH		–	14	18	ns
t_{dZL}	enable LOW		–	16	20	ns
t_{dHZ}	disable HIGH		–	16	20	ns
t_{dLZ}	disable LOW		–	14	18	ns

Notes

- The circuit has two clock inputs: CLK and $\overline{\text{CLK}}$. There are four modes of operation:
 - PECL mode 1 (DC level varies equal to DC level of V_{CCD}): CLK and $\overline{\text{CLK}}$ inputs are at differential PECL levels.
 - PECL mode 2 (DC level varies equal to DC level of V_{CCD}): CLK input is at PECL level and sampling is taken on the falling edge of the clock input signal. A DC level of 3.65 V has to be applied on $\overline{\text{CLK}}$ decoupled to GND via a 100 nF capacitor.
 - PECL mode 3 (DC level varies equal to DC level of V_{CCD}): $\overline{\text{CLK}}$ input is at PECL level and sampling is taken on the rising edge of the clock input signal. A DC level of 3.65 V has to be applied on CLK decoupled to GND via a 100 nF capacitor.
 - AC driving mode 4: when driving the CLK input directly and with any AC signal of minimum 0.5 V (p-p) and with a DC level of 2.5 V, the sampling takes place at the falling edge of the clock signal.
When driving the $\overline{\text{CLK}}$ input with the same signal, sampling takes place at the rising edge of the clock signal. It is recommended to decouple the $\overline{\text{CLK}}$ or CLK input to DGND via a 100 nF capacitor.
- It is possible with an external reference connected to pin V_{ref} to adjust the ADC input range. This voltage has to be referenced to V_{CCA} . For $V_{CCA} = 1.825$ V, the differential input voltage amplitude is 2 V (p-p).
- The –3 dB analog bandwidth is determined by the 3 dB reduction in the reconstructed output, the input being a full-scale sine wave.
- THD (total harmonic distortion) is obtained with the addition of the first five harmonics:
$$\text{THD} = 20 \log \frac{F}{\sqrt{(2\text{nd})^2 + (3\text{rd})^2 + (4\text{th})^2 + (5\text{th})^2 + (6\text{th})^2}}$$

where F is the fundamental harmonic referenced at 0 dB for a full-scale sine wave input.
- Effective number of bits are obtained via a Fast Fourier Transform (FFT). The calculation takes into account all harmonics and noise up to half of the clock frequency (Nyquist frequency). Conversion to SNR:
 $\text{SNR} = N_{\text{bit}} \times 6.02 + 1.76$ dB.
- Intermodulation measured relative to either tone with analog input frequencies of 4.43 and 4.53 MHz. The two input signals have the same amplitude and the total amplitude of both signals provides full-scale to the converter (–6 dB below full scale for each input signal).
 d_3 is the ratio of the RMS-value of either input tone to the RMS-value of the worst case third order intermodulation product.
- Output data acquisition: the output data is available after the maximum delay of t_d .

10-bit high-speed Analog-to-Digital Converter (ADC)

TDA8765

Table 1 Output coding with differential inputs (typical values to AGND); $V_{i(p-p)} - \bar{V}_{i(p-p)} = 2.0\text{ V}$; $V_{ref} = V_{CCA} - 1.825\text{ V}$

CODE	$V_{i(p-p)}$	$\bar{V}_{i(p-p)}$	IR	BINARY OUTPUTS	TWOS COMPLEMENT OUTPUTS
				D9 TO D0	D9 TO D0
Underflow	<3.1	>4.1	0	0 0 0 0 0 0 0 0 0 0	1 0 0 0 0 0 0 0 0 0
0	3.1	4.1	1	0 0 0 0 0 0 0 0 0 0	1 0 0 0 0 0 0 0 0 0
1	–	–	1	0 0 0 0 0 0 0 0 0 1	1 0 0 0 0 0 0 0 0 1
↓	–	–	↓	↓	↓
511	3.6	3.6	1	0 1 1 1 1 1 1 1 1 1	1 1 1 1 1 1 1 1 1 1
↓	–	–	↓	↓	↓
1022	–	–	1	1 1 1 1 1 1 1 1 1 0	0 1 1 1 1 1 1 1 1 0
1023	4.1	3.1	1	1 1 1 1 1 1 1 1 1 1	0 1 1 1 1 1 1 1 1 1
Overflow	>4.1	<3.1	0	1 1 1 1 1 1 1 1 1 1	0 1 1 1 1 1 1 1 1 1

Table 2 Mode selection

OTC	\overline{CE}	D0 TO D9 AND IR
0	0	binary; active
1	0	twos complement; active
X ⁽¹⁾	1	high impedance

Note

1. X = don't care.

Table 3 Sample-and-hold selection

SH	SAMPLE-AND-HOLD
1	active
0	inactive; tracking mode

10-bit high-speed Analog-to-Digital Converter (ADC)

TDA8765

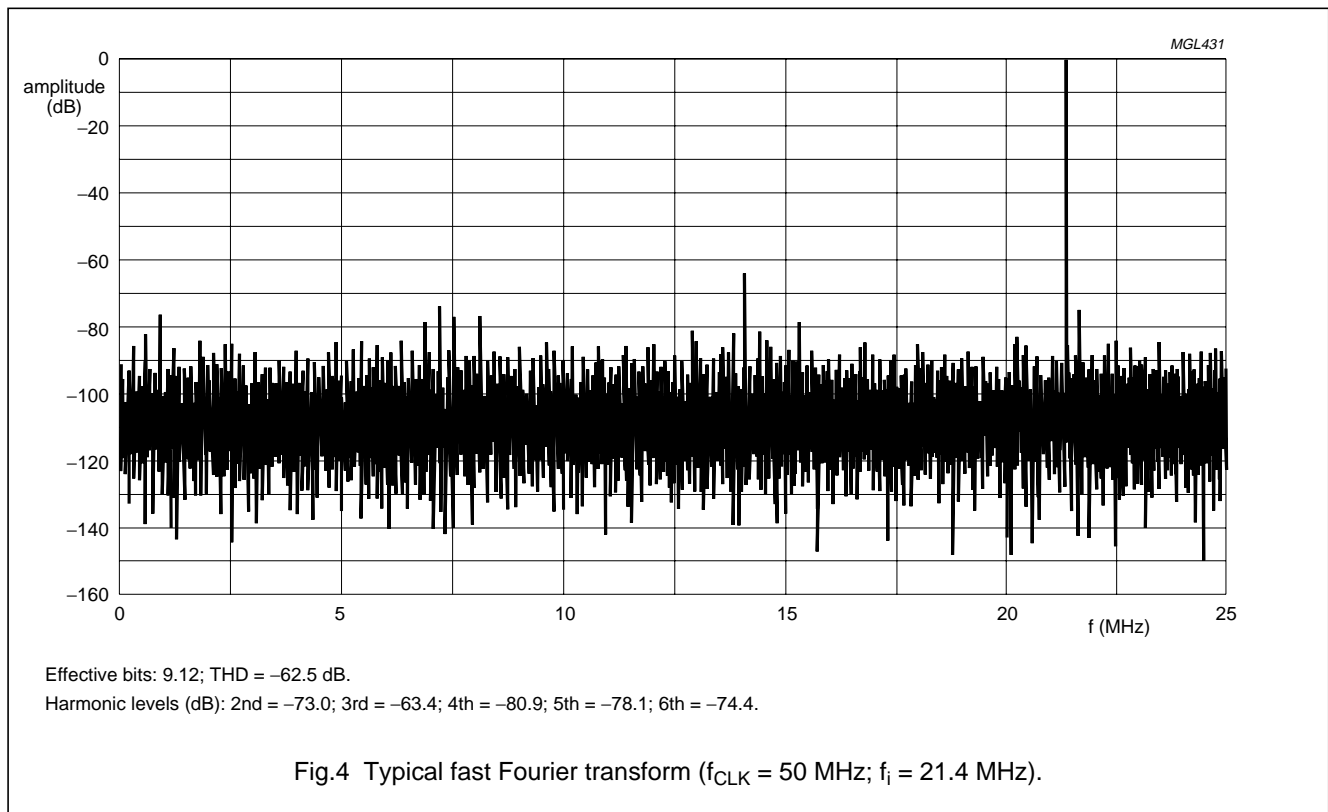
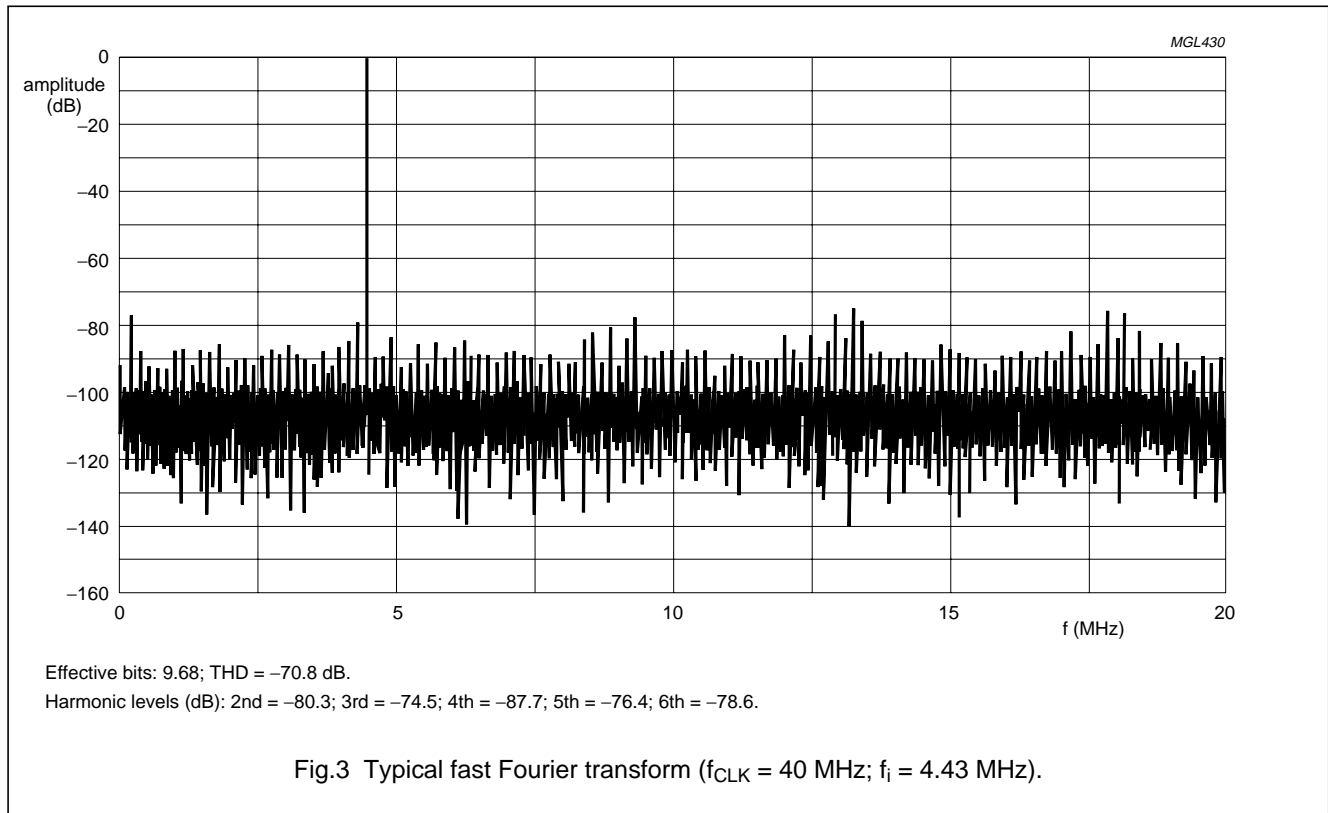

10-bit high-speed Analog-to-Digital Converter (ADC)

TDA8765

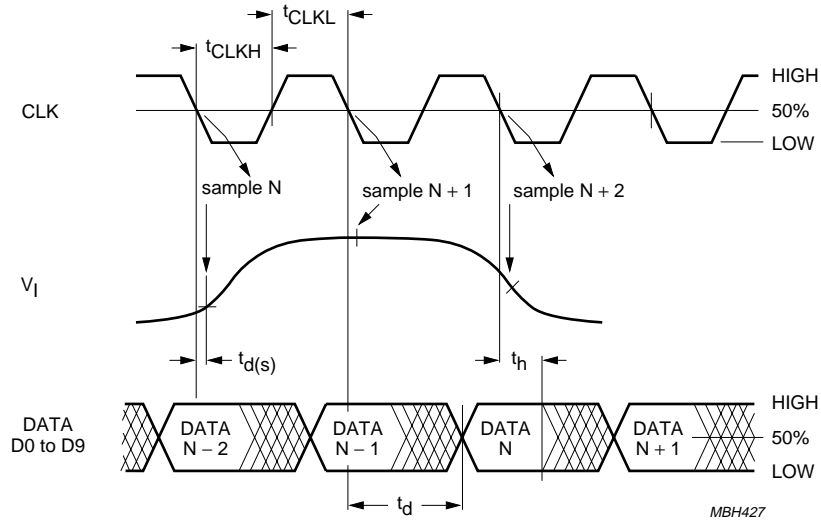
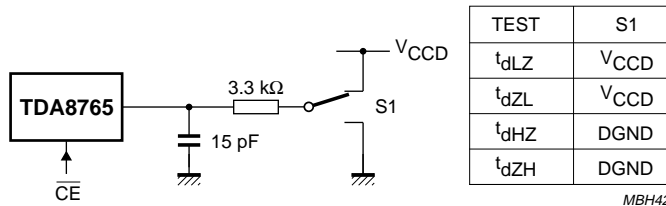
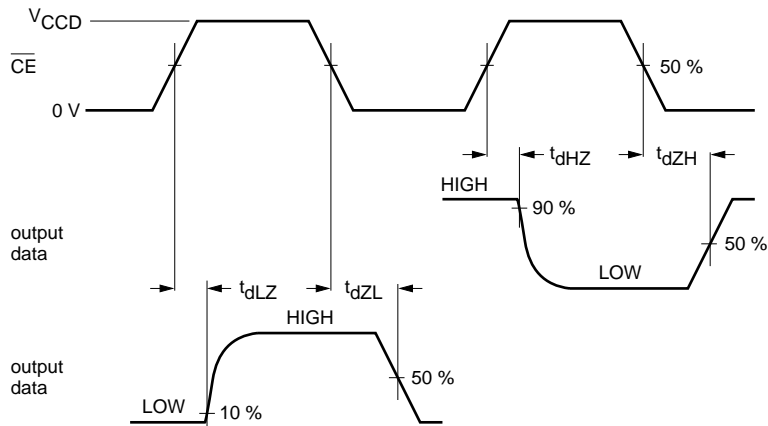

Fig.5 Timing diagram.



TEST	S1
t_{dLZ}	V_{CCD}
t_{dZL}	V_{CCD}
t_{dHZ}	DGND
t_{dZH}	DGND

$f_{CE} = 100 \text{ kHz}$.

Fig.6 Timing diagram and test conditions of 3-state output delay time.

10-bit high-speed Analog-to-Digital Converter (ADC)

TDA8765

APPLICATION INFORMATION

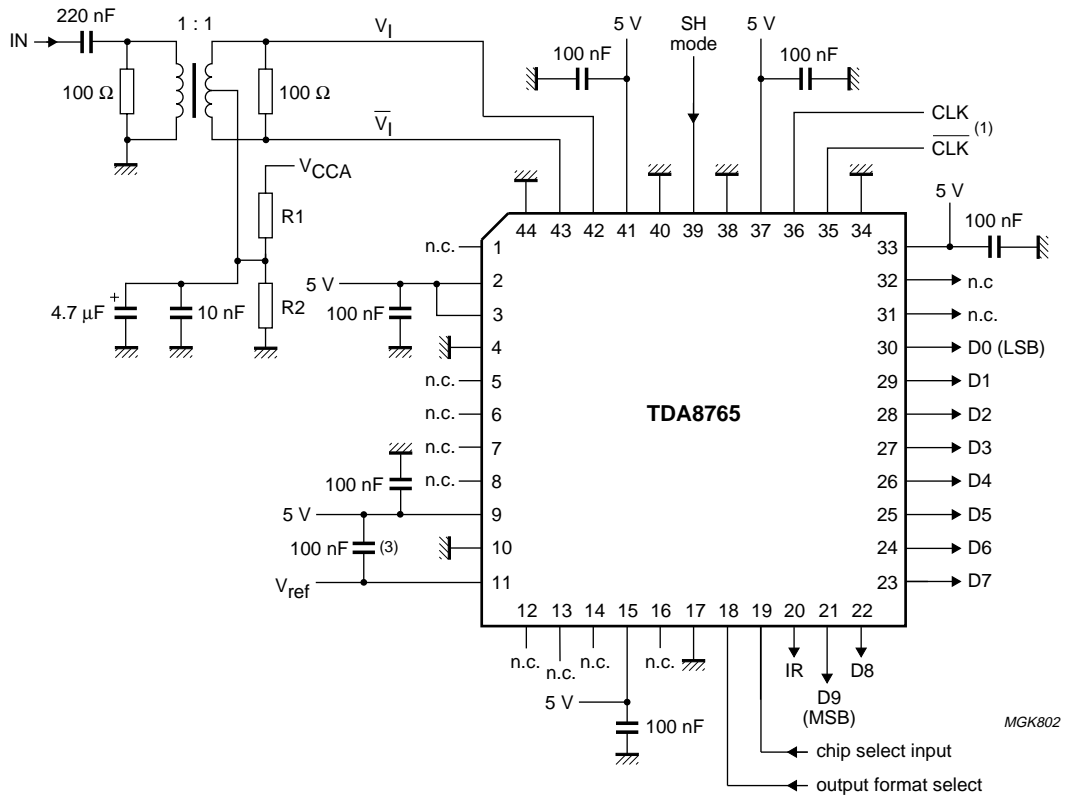

The analog, digital and output supplies should be separated and decoupled.

- (1) Single-ended clock signals can be applied if required.
- (2) R1 and R2 must be determined in order to obtain a middle voltage of 3.6 V; see common mode input voltage. In addition, the minimum current into these resistors should be about 1 mA in order to ensure a sufficient analog input stability.
- (3) V_{ref} must be decoupled to V_{CCA}.

Fig.7 Application diagram.

10-bit high-speed Analog-to-Digital Converter (ADC)

TDA8765

PACKAGE OUTLINE

QFP44: plastic quad flat package; 44 leads (lead length 1.3 mm); body 10 x 10 x 1.75 mm

SOT307-2

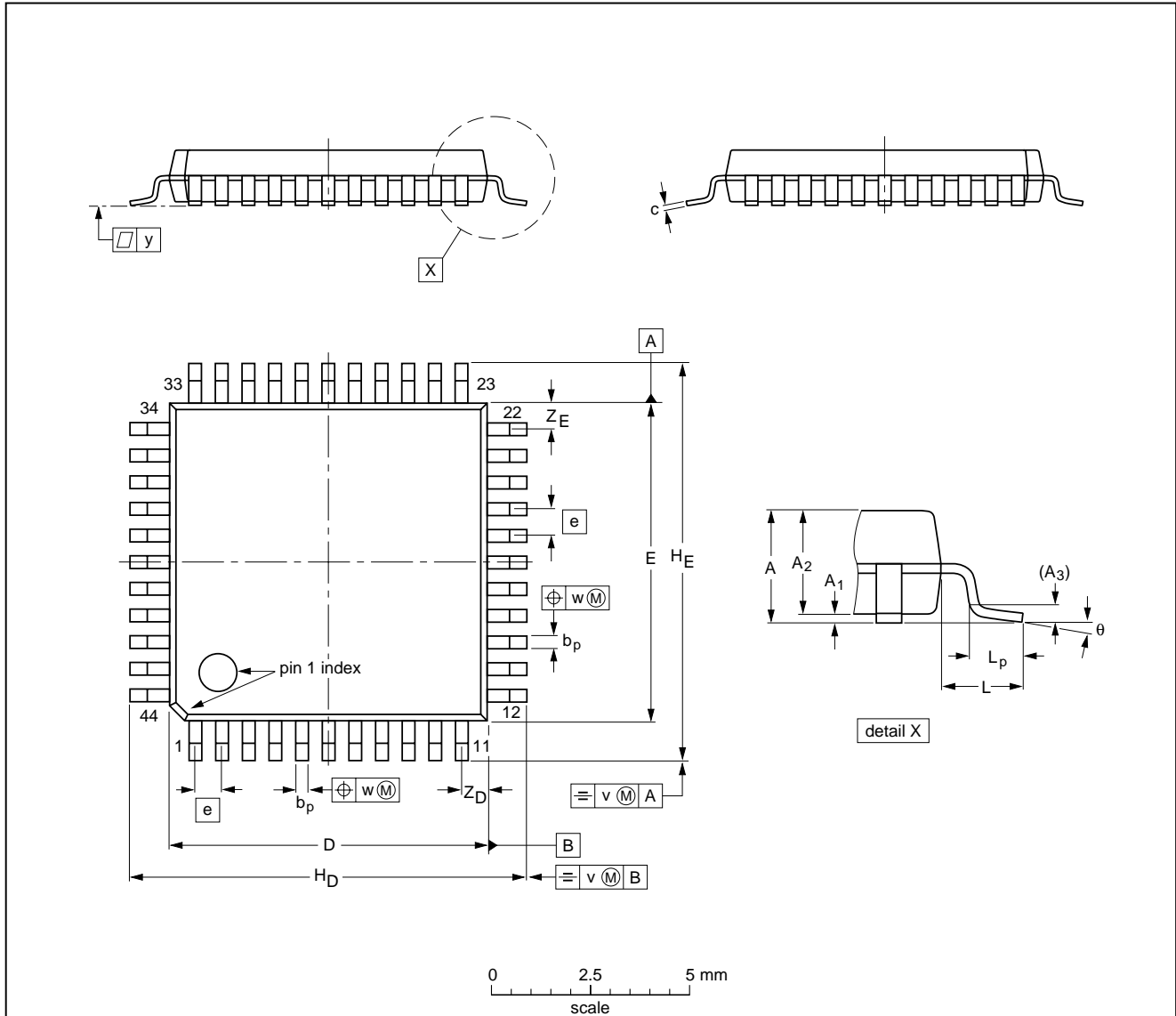

DIMENSIONS (mm are the original dimensions)

UNIT	A max.	A ₁	A ₂	A ₃	b _p	c	D ⁽¹⁾	E ⁽¹⁾	e	H _D	H _E	L	L _p	v	w	y	Z _D ⁽¹⁾	Z _E ⁽¹⁾	θ
mm	2.10	0.25 0.05	1.85 1.65	0.25	0.40 0.20	0.25 0.14	10.1 9.9	10.1 9.9	0.8	12.9 12.3	12.9 12.3	1.3	0.95 0.55	0.15	0.15	0.1	1.2 0.8	1.2 0.8	10° 0°

Note

1. Plastic or metal protrusions of 0.25 mm maximum per side are not included.

OUTLINE VERSION	REFERENCES				EUROPEAN PROJECTION	ISSUE DATE
	IEC	JEDEC	EIAJ			
SOT307-2						95-02-04 97-08-01

10-bit high-speed Analog-to-Digital Converter (ADC)

TDA8765

SOLDERING

Introduction to soldering surface mount packages

This text gives a very brief insight to a complex technology. A more in-depth account of soldering ICs can be found in our *"Data Handbook IC26; Integrated Circuit Packages"* (document order number 9398 652 90011).

There is no soldering method that is ideal for all surface mount IC packages. Wave soldering is not always suitable for surface mount ICs, or for printed-circuit boards with high population densities. In these situations reflow soldering is often used.

Reflow soldering

Reflow soldering requires solder paste (a suspension of fine solder particles, flux and binding agent) to be applied to the printed-circuit board by screen printing, stencilling or pressure-syringe dispensing before package placement.

Several methods exist for reflowing; for example, infrared/convection heating in a conveyor type oven. Throughput times (preheating, soldering and cooling) vary between 100 and 200 seconds depending on heating method.

Typical reflow peak temperatures range from 215 to 250 °C. The top-surface temperature of the packages should preferably be kept below 230 °C.

Wave soldering

Conventional single wave soldering is not recommended for surface mount devices (SMDs) or printed-circuit boards with a high component density, as solder bridging and non-wetting can present major problems.

To overcome these problems the double-wave soldering method was specifically developed.

If wave soldering is used the following conditions must be observed for optimal results:

- Use a double-wave soldering method comprising a turbulent wave with high upward pressure followed by a smooth laminar wave.
- For packages with leads on two sides and a pitch (e):
 - larger than or equal to 1.27 mm, the footprint longitudinal axis is **preferred** to be parallel to the transport direction of the printed-circuit board;
 - smaller than 1.27 mm, the footprint longitudinal axis **must** be parallel to the transport direction of the printed-circuit board.

The footprint must incorporate solder thieves at the downstream end.

- For packages with leads on four sides, the footprint must be placed at a 45° angle to the transport direction of the printed-circuit board. The footprint must incorporate solder thieves downstream and at the side corners.

During placement and before soldering, the package must be fixed with a droplet of adhesive. The adhesive can be applied by screen printing, pin transfer or syringe dispensing. The package can be soldered after the adhesive is cured.

Typical dwell time is 4 seconds at 250 °C. A mildly-activated flux will eliminate the need for removal of corrosive residues in most applications.

Manual soldering

Fix the component by first soldering two diagonally-opposite end leads. Use a low voltage (24 V or less) soldering iron applied to the flat part of the lead. Contact time must be limited to 10 seconds at up to 300 °C.

When using a dedicated tool, all other leads can be soldered in one operation within 2 to 5 seconds between 270 and 320 °C.

10-bit high-speed Analog-to-Digital Converter (ADC)

TDA8765

Suitability of surface mount IC packages for wave and reflow soldering methods

PACKAGE	SOLDERING METHOD	
	WAVE	REFLOW ⁽¹⁾
BGA, SQFP	not suitable	suitable
HLQFP, HSQFP, HSOP, HTSSOP, SMS	not suitable ⁽²⁾	suitable
PLCC ⁽³⁾ , SO, SOJ	suitable	suitable
LQFP, QFP, TQFP	not recommended ⁽³⁾⁽⁴⁾	suitable
SSOP, TSSOP, VSO	not recommended ⁽⁵⁾	suitable

Notes

- All surface mount (SMD) packages are moisture sensitive. Depending upon the moisture content, the maximum temperature (with respect to time) and body size of the package, there is a risk that internal or external package cracks may occur due to vaporization of the moisture in them (the so called popcorn effect). For details, refer to the Drypack information in the "Data Handbook IC26; Integrated Circuit Packages; Section: Packing Methods".
- These packages are not suitable for wave soldering as a solder joint between the printed-circuit board and heatsink (at bottom version) can not be achieved, and as solder may stick to the heatsink (on top version).
- If wave soldering is considered, then the package must be placed at a 45° angle to the solder wave direction. The package footprint must incorporate solder thieves downstream and at the side corners.
- Wave soldering is only suitable for LQFP, TQFP and QFP packages with a pitch (e) equal to or larger than 0.8 mm; it is definitely not suitable for packages with a pitch (e) equal to or smaller than 0.65 mm.
- Wave soldering is only suitable for SSOP and TSSOP packages with a pitch (e) equal to or larger than 0.65 mm; it is definitely not suitable for packages with a pitch (e) equal to or smaller than 0.5 mm.

DEFINITIONS

Data sheet status	
Objective specification	This data sheet contains target or goal specifications for product development.
Preliminary specification	This data sheet contains preliminary data; supplementary data may be published later.
Product specification	This data sheet contains final product specifications.
Limiting values	
Limiting values given are in accordance with the Absolute Maximum Rating System (IEC 134). Stress above one or more of the limiting values may cause permanent damage to the device. These are stress ratings only and operation of the device at these or at any other conditions above those given in the Characteristics sections of the specification is not implied. Exposure to limiting values for extended periods may affect device reliability.	
Application information	
Where application information is given, it is advisory and does not form part of the specification.	

LIFE SUPPORT APPLICATIONS

These products are not designed for use in life support appliances, devices, or systems where malfunction of these products can reasonably be expected to result in personal injury. Philips customers using or selling these products for use in such applications do so at their own risk and agree to fully indemnify Philips for any damages resulting from such improper use or sale.

10-bit high-speed Analog-to-Digital
Converter (ADC)

TDA8765

NOTES

10-bit high-speed Analog-to-Digital
Converter (ADC)

TDA8765

NOTES

Philips Semiconductors – a worldwide company

Argentina: see South America

Australia: 34 Waterloo Road, NORTH RYDE, NSW 2113, Tel. +61 2 9805 4455, Fax. +61 2 9805 4466

Austria: Computerstr. 6, A-1101 WIEN, P.O. Box 213, Tel. +43 1 60 101 1248, Fax. +43 1 60 101 1210

Belarus: Hotel Minsk Business Center, Bld. 3, r. 1211, Volodarski Str. 6, 220050 MINSK, Tel. +375 172 20 0733, Fax. +375 172 20 0773

Belgium: see The Netherlands

Brazil: see South America

Bulgaria: Philips Bulgaria Ltd., Energoproject, 15th floor, 51 James Bourchier Blvd., 1407 SOFIA, Tel. +359 2 68 9211, Fax. +359 2 68 9102

Canada: PHILIPS SEMICONDUCTORS/COMPONENTS, Tel. +1 800 234 7381, Fax. +1 800 943 0087

China/Hong Kong: 501 Hong Kong Industrial Technology Centre, 72 Tat Chee Avenue, Kowloon Tong, HONG KONG, Tel. +852 2319 7888, Fax. +852 2319 7700

Colombia: see South America

Czech Republic: see Austria

Denmark: Sydhavnsgade 23, 1780 COPENHAGEN V, Tel. +45 33 29 3333, Fax. +45 33 29 3905

Finland: Sinikalliontie 3, FIN-02630 ESPOO, Tel. +358 9 615 800, Fax. +358 9 6158 0920

France: 51 Rue Carnot, BP317, 92156 SURESNES Cedex, Tel. +33 1 4099 6161, Fax. +33 1 4099 6427

Germany: Hammerbrookstraße 69, D-20097 HAMBURG, Tel. +49 40 2353 60, Fax. +49 40 2353 6300

Greece: No. 15, 25th March Street, GR 17778 TAVROS/ATHENS, Tel. +30 1 489 4339/4239, Fax. +30 1 481 4240

Hungary: see Austria

India: Philips INDIA Ltd, Band Box Building, 2nd floor, 254-D, Dr. Annie Besant Road, Worli, MUMBAI 400 025, Tel. +91 22 493 8541, Fax. +91 22 493 0966

Indonesia: PT Philips Development Corporation, Semiconductors Division, Gedung Philips, Jl. Buncit Raya Kav.99-100, JAKARTA 12510, Tel. +62 21 794 0040 ext. 2501, Fax. +62 21 794 0080

Ireland: Newstead, Clonskeagh, DUBLIN 14, Tel. +353 1 7640 000, Fax. +353 1 7640 200

Israel: RAPAC Electronics, 7 Kehilat Saloniki St, PO Box 18053, TEL AVIV 61180, Tel. +972 3 645 0444, Fax. +972 3 649 1007

Italy: PHILIPS SEMICONDUCTORS, Piazza IV Novembre 3, 20124 MILANO, Tel. +39 2 6752 2531, Fax. +39 2 6752 2557

Japan: Philips Bldg 13-37, Kohnan 2-chome, Minato-ku, TOKYO 108-8507, Tel. +81 3 3740 5130, Fax. +81 3 3740 5077

Korea: Philips House, 260-199 Itaewon-dong, Yongsan-ku, SEOUL, Tel. +82 2 709 1412, Fax. +82 2 709 1415

Malaysia: No. 76 Jalan Universiti, 46200 PETALING JAYA, SELANGOR, Tel. +60 3 750 5214, Fax. +60 3 757 4880

Mexico: 5900 Gateway East, Suite 200, EL PASO, TEXAS 79905, Tel. +9-5 800 234 7381, Fax +9-5 800 943 0087

Middle East: see Italy

Netherlands: Postbus 90050, 5600 PB EINDHOVEN, Bldg. VB, Tel. +31 40 27 82785, Fax. +31 40 27 88399

New Zealand: 2 Wagener Place, C.P.O. Box 1041, AUCKLAND, Tel. +64 9 849 4160, Fax. +64 9 849 7811

Norway: Box 1, Manglerud 0612, OSLO, Tel. +47 22 74 8000, Fax. +47 22 74 8341

Pakistan: see Singapore

Philippines: Philips Semiconductors Philippines Inc., 106 Valero St. Salcedo Village, P.O. Box 2108 MCC, MAKATI, Metro MANILA, Tel. +63 2 816 6380, Fax. +63 2 817 3474

Poland: Ul. Lukiska 10, PL 04-123 WARSZAWA, Tel. +48 22 612 2831, Fax. +48 22 612 2327

Portugal: see Spain

Romania: see Italy

Russia: Philips Russia, Ul. Usatcheva 35A, 119048 MOSCOW, Tel. +7 095 755 6918, Fax. +7 095 755 6919

Singapore: Lorong 1, Toa Payoh, SINGAPORE 319762, Tel. +65 350 2538, Fax. +65 251 6500

Slovakia: see Austria

Slovenia: see Italy

South Africa: S.A. PHILIPS Pty Ltd., 195-215 Main Road Martindale, 2092 JOHANNESBURG, P.O. Box 7430 Johannesburg 2000, Tel. +27 11 470 5911, Fax. +27 11 470 5494

South America: Al. Vicente Pinzon, 173, 6th floor, 04547-130 SÃO PAULO, SP, Brazil, Tel. +55 11 821 2333, Fax. +55 11 821 2382

Spain: Balmes 22, 08007 BARCELONA, Tel. +34 93 301 6312, Fax. +34 93 301 4107

Sweden: Kottbygatan 7, Akalla, S-16485 STOCKHOLM, Tel. +46 8 5985 2000, Fax. +46 8 5985 2745

Switzerland: Allmendstrasse 140, CH-8027 ZÜRICH, Tel. +41 1 488 2741 Fax. +41 1 488 3263

Taiwan: Philips Semiconductors, 6F, No. 96, Chien Kuo N. Rd., Sec. 1, TAIPEI, Taiwan Tel. +886 2 2134 2865, Fax. +886 2 2134 2874

Thailand: PHILIPS ELECTRONICS (THAILAND) Ltd., 209/2 Sanpavuth-Bangna Road Prakanong, BANGKOK 10260, Tel. +66 2 745 4090, Fax. +66 2 398 0793

Turkey: Talatpasa Cad. No. 5, 80640 GÜLTEPE/ISTANBUL, Tel. +90 212 279 2770, Fax. +90 212 282 6707

Ukraine: PHILIPS UKRAINE, 4 Patrice Lumumba str., Building B, Floor 7, 252042 KIEV, Tel. +380 44 264 2776, Fax. +380 44 268 0461

United Kingdom: Philips Semiconductors Ltd., 276 Bath Road, Hayes, MIDDLESEX UB3 5BX, Tel. +44 181 730 5000, Fax. +44 181 754 8421

United States: 811 East Arques Avenue, SUNNYVALE, CA 94088-3409, Tel. +1 800 234 7381, Fax. +1 800 943 0087

Uruguay: see South America

Vietnam: see Singapore

Yugoslavia: PHILIPS, Trg N. Pasica 5/v, 11000 BEOGRAD, Tel. +381 11 62 5344, Fax. +381 11 63 5777

For all other countries apply to: Philips Semiconductors, International Marketing & Sales Communications, Building BE-p, P.O. Box 218, 5600 MD EINDHOVEN, The Netherlands, Fax. +31 40 27 24825

Internet: <http://www.semiconductors.philips.com>

© Philips Electronics N.V. 1999

SCA61

All rights are reserved. Reproduction in whole or in part is prohibited without the prior written consent of the copyright owner.

The information presented in this document does not form part of any quotation or contract, is believed to be accurate and reliable and may be changed without notice. No liability will be accepted by the publisher for any consequence of its use. Publication thereof does not convey nor imply any license under patent- or other industrial or intellectual property rights.

Printed in The Netherlands

545104/750/02/pp20

Date of release: 1999 Jan 06

Document order number: 9397 750 04716

Let's make things better.

**Philips
Semiconductors**



PHILIPS